

ON THE MOON

NASA AND DESIGN SQUAD TEAM UP TO
INSPIRE A NEW GENERATION OF ENGINEERS

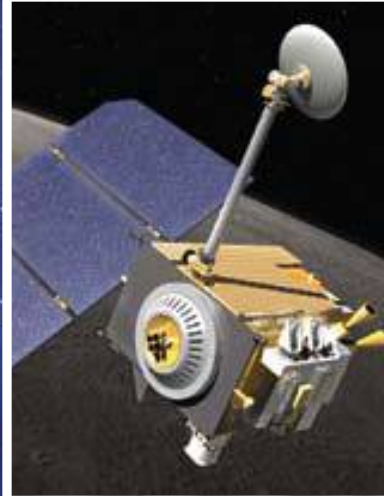

in collaboration with the
National Aeronautics and
Space Administration

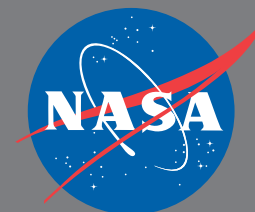

ENGINEERING
CHALLENGES
FOR SCHOOL AND
AFTERSCHOOL
PROGRAMS
GRADES 3-12

National Aeronautics and Space Administration

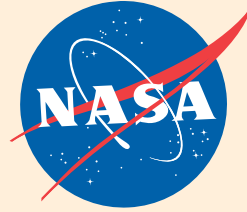

Dear Educators,

In 2004, President Bush announced a new vision for the United States' space program. Today, that vision is becoming reality. The men and women of NASA are working on the next generation of spacecraft that will return Americans to the moon by 2020. A new generation of students across the country and around the world will be inspired by what President Kennedy called the "greatest adventure on which humankind has ever embarked."

As NASA prepares for the future of exploration, we recognize that the young people of today are the engineers, scientists, and astronauts of tomorrow. Creativity, curiosity, and analytical thinking are the trusted tools of NASA's engineering arsenal, and we continually direct our educational efforts to create experiences that allow young people to develop these skills as they investigate and solve challenging problems.

NASA is proud to partner with *Design Squad*®, PBS's reality competition series focused on the fun and excitement of engineering. Central to this partnership is our belief that science, technology, engineering, and mathematics education will play a vital role in solving the problems of the 21st century. *On the Moon* is part of our long, proud tradition of showcasing how engineering fuels space exploration. By structuring the activities around real-world engineering applications, it is our hope that you will find the *On the Moon* activities to be effective, innovative ways to engage your students in the engineering design process, encourage their interest in space exploration, and inspire them to pursue a career in engineering.

NASA supports people like you who play a key role in preparing the minds that will strengthen the Nation's future. Use this guide to bring the possibilities of engineering to life for young people and to inspire them to solve challenging problems. Engage their creativity, foster their curiosity, and teach them to autograph their work with excellence.

Sincerely,

A handwritten signature in black ink that reads "Joyce L. Winterton". The signature is fluid and cursive, with the first letters of each word being capitalized and prominent.

Joyce Winterton
Assistant Administrator for Education

WHAT'S IN THIS GUIDE

NASA and *Design Squad*® team up to bring kids in your school or afterschool program six hands-on challenges. These fun challenges will get your kids thinking like engineers and excited about NASA's missions to the moon.

Why Have NASA and <i>Design Squad</i> Teamed Up?	1
Introducing the Design Process	2
How to Use this Guide	3
Going to the Moon with NASA	5
Talking with Kids about Engineering	7
Online Resources from NASA and <i>Design Squad</i>	8
Challenges:	
Launch It	9
Design an air-powered rocket that can hit a distant target.	
Touchdown	13
Create a platform that can safely cushion “astronauts” when they land on a table near you.	
Roving on the Moon	17
Build a rubber band powered rover that can scramble across the room.	
Heavy Lifting	22
Build a cardboard crane and see how heavy a load it can lift.	
On Target	27
Modify a paper cup so it can zip down a line and drop a marble onto a target.	
Feel the Heat	32
Heat things up by building a solar hot water heater.	
Education Standards	37
Credits	44

WANT MORE CHALLENGES LIKE THESE?

Get *Design Squad* challenges, activity guides, games, and much more at pbs.org/designsquad.

WHY HAVE NASA AND DESIGN SQUAD TEAMED UP?

NASA is one of the biggest employers of engineers in the world—about 90,000 among its own employees and its corporate partners. So it's not surprising that NASA wants kids to learn more about engineering, become interested in the things engineers do, and experience the world of engineering firsthand.

Design Squad is all about engaging kids in engineering by offering them opportunities to give it a try. Through its award-winning TV program, Web site, and hands-on challenges, *Design Squad* helps kids unleash their creativity, experience the fun and excitement of engineering, and see that engineers make an important difference in the world.

By teaming up to develop the *On the Moon* guide, NASA and *Design Squad* help you bring hands-on engineering and the adventure of space exploration to life for kids.

NASA EXPLORES SPACE

What's out there in space? How do we get there? What will we find? What can we discover there, or learn just by trying to get there, that will make life better here on Earth? NASA has been working on these questions for over 50 years, pioneering space exploration, scientific discovery, and aeronautics research.

NASA scientists and engineers work in a wide range of settings around the country, from laboratories to airfields to wind tunnels to control rooms. The main areas they work in are:

- **Aeronautics:** where they pioneer new flight technologies that have practical applications on Earth and improve our ability to explore space.
- **Exploration Systems:** where they create new technologies and spacecraft that make human and robotic exploration more affordable and sustainable.
- **Science:** where they explore Earth, the moon, Mars, and beyond; chart the best ways to learn about the universe; and help society reap the benefits of Earth and space exploration.
- **Space Operations:** where they manage the space shuttle and International Space Station and provide flight support.

DESIGN SQUAD ENGAGES KIDS IN ENGINEERING

Design Squad is an award-winning TV show that airs on PBS. It's a powerful way to open kids' eyes to the exciting world of engineering. On the show, two teams of teenagers take on a wide array of imaginative engineering challenges. The lively action and fun-filled challenges demonstrate for viewers the rich variety of problems that engineers tackle as they work to improve people's lives and our society. *Design Squad's* Web site and activity guides put a range of valuable resources into the hands of educators, parents, and kids. These materials engage and empower kids by having them use their ingenuity to solve problems and design and build interesting projects.

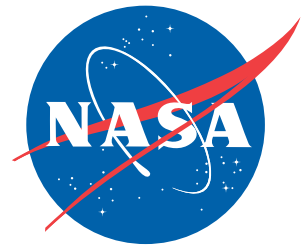

NASA wants kids to learn more about engineering.

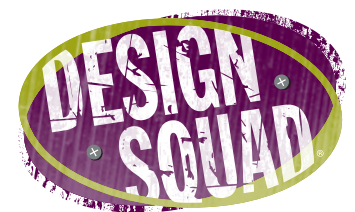

Design Squad helps kids experience the fun and excitement of engineering.

INTRODUCING THE DESIGN PROCESS

When NASA engineers try to solve a problem, their initial ideas rarely work out perfectly. Like all engineers, they try different ideas, learn from mistakes, and try again. The series of steps engineers use to arrive at a solution is called the **design process**.

As kids work through a challenge, use questions such as the ones below to talk about their work and tie what they're doing to specific steps of the design process.

BRAINSTORMING

- At this stage, all ideas are welcome, and criticism is not allowed.
- What are some different ways to start tackling today's challenge?

DESIGNING

- Talk through the brainstormed ideas. What's really possible given your time, tools, and materials?
- What specific goal are you trying to achieve, and how will you know if you've been successful?
- What are some problems you'll need to solve as you build your project?

BUILDING, TESTING, EVALUATING, AND REDESIGNING

- Does your design meet the goal set out in the challenge?
- Why do you have to test something a few times before getting it to work the way you want?
- What can you learn from looking at other kids' projects and discussing them?

SHARING SOLUTIONS

- What were the different steps you had to do to get your project to work the way you wanted?
- What do you think is the best feature of your design? Why?
- What are some things everyone's designs have in common?
- If you had more time, how could you improve your design?

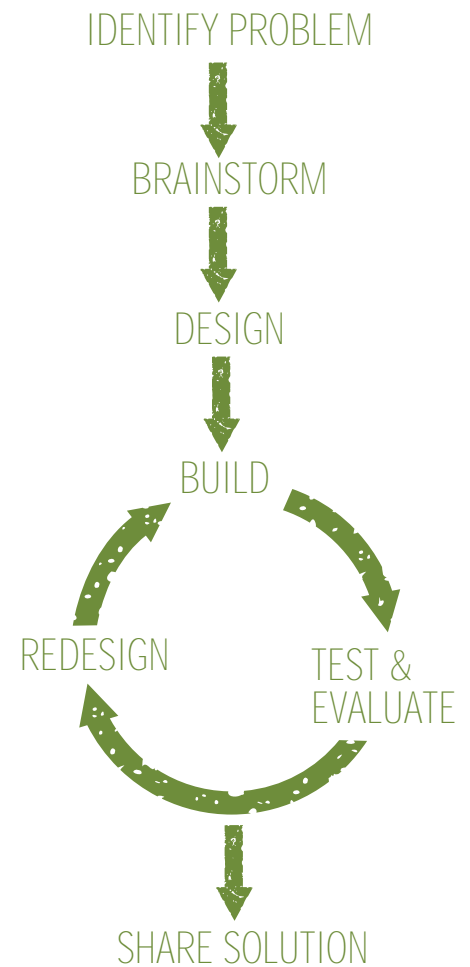

Photo: Lauren Feinberg

The design process is built into each challenge. Over the course of doing a challenge, kids see that the steps of the design process let them think creatively about a problem and produce a successful result.

HOW TO USE THIS GUIDE

This guide offers six hands-on challenges that bring engineering and NASA's moon missions to life for kids in schools and afterschool programs. The challenges take an hour (except *Feel the Heat*, which takes 1½ to 2 hours), use readily available materials, give kids many ways to succeed, and can be done with large groups. The activities also meet many of the national science, technology, and mathematics standards.

HOW TO GET STARTED

Choose a challenge. You'll want to consider the number of the kids in your group and their ages and ability levels. The chart below will help you find the right activities for your program's age group. Also check the related Science, Math, and Technology Standards starting on page 37 to find challenges that are a good match for your curriculum.

Challenge	Events	Grades 3–5	Grades 6–8	Grades 9–12
Launch It	✓	✓	✓	
Touchdown	✓	✓	✓	
Roving on the Moon			✓	✓
Heavy Lifting			✓	✓
On Target			✓	✓
Feel the Heat				✓

Read the leader notes. These notes will assist you in facilitating the challenges. They include suggestions to help you prepare for, introduce, and run the activity as well as discussion questions to help kids explore the activity's science, engineering, and space-related themes.

Try the activity yourself. A practice run will help you figure out the best way to introduce the activity and anticipate potential problems your kids may run into.

Print the challenge sheet. This handout walks kids through a challenge, providing them with a materials list, questions to brainstorm, building tips, and interesting stories related to the challenge.

Get kids excited about NASA's moon missions. By the year 2020, NASA plans to build an outpost on the moon and have teams of astronauts live there. Get your kids excited about what's involved in living and working on the moon. On pages 5 and 6, you'll find a brief description of NASA and two of its moon missions. Share this information with your kids.

Decorate the room with space images. You can motivate kids and help them visualize the moon and NASA's moon missions by displaying space-related images. NASA has many excellent ones you can print out. (Visit moon.msfc.nasa.gov.) To get the NASA images used in this guide, use the URL found below each image.

LEADING A CHALLENGE

Never led an engineering challenge before? Don't worry! From getting started, to helping kids succeed, to wrapping up the activity, the leader notes give you all you need to facilitate a challenge with kids. The leader notes are divided into the following sections:

Prepare ahead of time: Lists things to do to get ready for the activity.

Introduce the challenge: Provides a script you can use to introduce the activity's key ideas and show how the challenge relates to NASA's goal of having people live on the moon.

Brainstorm and design: Helps kids think about different ways to meet a challenge. Since challenges offer kids many ways of succeeding, this section jump starts their thinking about various approaches and possibilities.

Build, test, evaluate, and redesign: Lists issues that might surface during a challenge and suggests strategies to use with kids who face these issues.

Discuss what happened: Provides questions (and answers) for reviewing the activity's key concepts, helping kids reflect on how they used the design process (see page 2 for an overview of this process), and highlighting how the challenge relates to NASA's moon-exploration efforts.

Extend the challenge: Presents short activities that kids can do to reinforce and expand the experiences they have had in a challenge.

Curriculum Connections: Lists the topics in a challenge that relate to concepts commonly covered in science, math, and technology curricula.

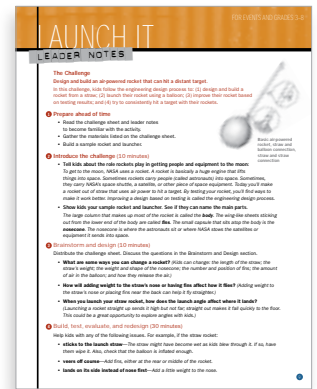

Leader notes page

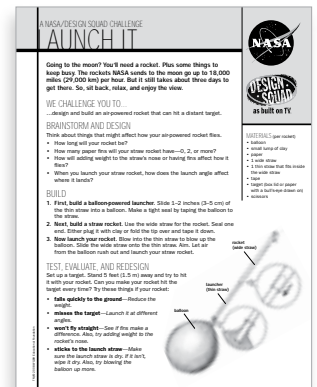

Kids' challenge sheet

TIPS FOR FACILITATING OPEN-ENDED CHALLENGES

- There are multiple ways to successfully tackle a challenge, so one successful solution is as good as another. Help kids see that the challenges are not competitions. Instead, they're opportunities to unleash an individual's ingenuity and creativity.
- When kids feel stuck, have them describe what they're doing by explaining why they think they got the results they did. Then ask questions to get kids back on track rather than telling them what to do. For example, ask: "Why do you think this is happening?" or "What would happen if...?" or "What is another thing you could try?"
- When something's not going as desired, encourage kids to try again. Problems are opportunities for learning and creative thinking.
- Have kids come up with several ways to solve a problem before they move ahead with an idea.



If a design doesn't work as planned, encourage kids to try again. Setbacks often lead to design improvements and success.

GOING TO THE MOON WITH NASA

Could people live on the moon for months at a time? Yes! By the year 2020, NASA plans to build a lunar outpost capable of housing teams of astronauts for six months or more. But there's a lot to learn before this can happen. Between now and then, NASA will prepare by sending several robotic missions to:

- identify good landing sites. Orbiting spacecraft will image and map the surface and identify hazards, such as steep slopes, rough terrain, and other obstacles.
- measure temperature, lighting, dust, and radiation levels. NASA needs to know this to design materials and equipment that will work reliably on the moon and assure astronaut safety.
- look for useful resources, such as minerals and ice. Shipping things from Earth is costly—over \$25,000 a pound! NASA needs astronauts to make as much as possible of what they need on site, using raw materials found on the moon, like calcium compounds to make cement and nitrogen compounds to fertilize crops.

The two missions featured in this guide—the Lunar Reconnaissance Orbiter and Lunar Crater Observation and Sensing Satellite—are the first two missions NASA is sending and are the first step in NASA's effort to return to the moon.

IMAGINATION FUELS INNOVATION

To explore the frontiers of Earth, the solar system, and the universe, NASA engineers find solutions to extraordinary challenges, and turn dreams into reality.

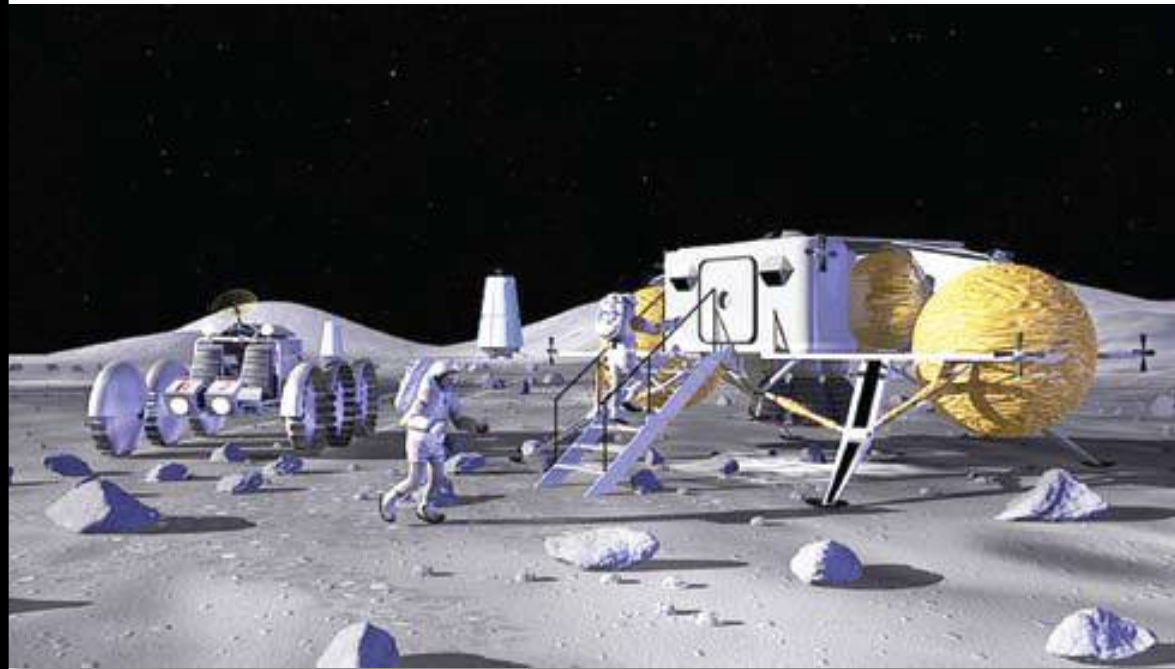

NASA plans to build a lunar outpost to house astronauts for six months or more. Get this image at: www.nasa.gov/images/content/148658main_jfa18833.jpg

THE LUNAR RECONNAISSANCE ORBITER (LRO)

LRO is an unmanned spacecraft that will orbit the moon for at least a year. It will help NASA select safe landing sites, study radiation levels on the moon, and identify lunar resources. LRO will use the following sensors to help NASA put together a comprehensive understanding of the moon's features and resources:

- **Cosmic-ray Telescope:** Studies the effects of radiation and its potential impact on living things.
- **Diviner Lunar Radiometer:** Gives detailed information about surface and subsurface temperatures as well as landing hazards, such as rocks and rough terrain.
- **Lyman Alpha Mapper:** Maps the surface of the moon, searches for ice and frost at the surface, and images the moon's permanently shadowed regions, such as at the bottom of deep craters.
- **Neutron Detector:** Maps the distribution of the element hydrogen, which is an indicator of possible water and ice. It also provides information about radiation on the moon.
- **Laser Altimeter:** Measures the steepness of slopes and surface roughness and generates a high-resolution, 3D map of the moon.
- **Camera:** Takes detailed pictures of the moon, capturing images of objects as small as one meter.
- **Radio Frequency Demonstration:** Searches for ice deposits beneath the surface of the moon.



LRO orbiting the moon. Get LRO images at: www.nasa.gov/mission_pages/LRO/multimedia/index.html.

THE LUNAR CRATER OBSERVATION AND SENSING SATELLITE (LCROSS)

LCROSS has a specific mission: search for ice. If astronauts are going to live on the moon for extended periods of time, finding water is essential. Astronauts need water to drink, and plants need it to grow. Water also can be broken down into oxygen, which can be used for breathing, and into hydrogen, which can be used for fuel for the return trip to Earth. Water is heavy, so sending all the water that a long-term mission needs from Earth would add considerable expense to the moon exploration budget.

LCROSS to the rescue! It's helping NASA look for a source of water on the moon. LCROSS will test the theory that ancient ice exists in the permanently shadowed craters near the moon's poles. Since no sunlight reaches the bottom of these deep craters, the dark, frigid conditions there are perfect for preserving possible ancient ice deposits. NASA is sending LCROSS's two sections hurtling into a crater near the moon's South Pole. Their impacts will make two deep pits in the crater floor, sending up a plume of dust and gas 6 miles (10 km) high. Instruments on the Lunar Reconnaissance Orbiter, the Hubble Space Telescope, and Earth will analyze the plume for the presence of water (ice and vapor), carbon compounds, and minerals that contain water.

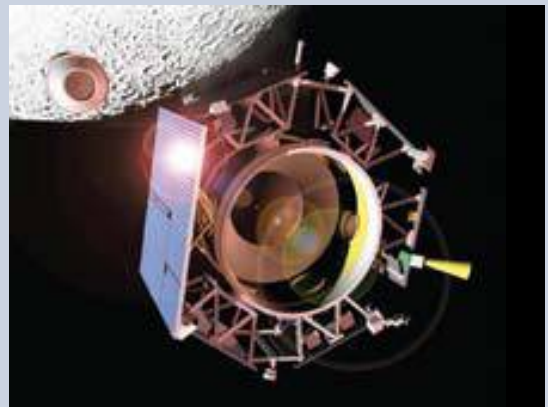

LCROSS approaches the moon. Get LCROSS images at: www.nasa.gov/mission_pages/LCROSS/multimedia/index.html.

TALKING WITH KIDS ABOUT ENGINEERING

Few kids can describe what engineering is or what an engineer does. Yet once they find out, many are hooked. You can be the one to help a young person discover just how cool engineering can be. As you work with kids, use the information below to talk with them about engineering.

WHAT'S AN ENGINEER?

Engineers dream up creative, practical solutions and work with other smart, inspiring people to invent, design, and build things that matter. They are changing the world all the time.

WHAT DO ENGINEERS DO?

- **Think creatively.** Engineering is an ideal outlet for imagination and creative problem solving—the perfect field for innovative thinkers.
- **Work with great people.** Engineering takes teamwork. As an engineer, you'll be surrounded by smart, creative people.
- **Solve problems and design things that matter.** Engineers improve people's lives by tackling problems, improving current designs, and coming up with solutions no one else has thought of.
- **Change the world and make a difference.** Among many other pursuits, engineers develop systems that save lives, prevent disease, reduce poverty, and protect our planet.

HOW DO ENGINEERS MAKE THE WORLD A BETTER PLACE?

Here are some things engineers do to help improve people's lives.

- Build spacecraft that travel to the moon
- Develop state-of-the-art cell phones
- Create more fuel-efficient cars
- Invent artificial retinas to help restore vision
- Design lighter bike frames
- Construct tall skyscrapers and high bridges
- Build systems to purify water and process waste
- Design clothing that repels mosquitoes
- Create satellites that detect drought around the world
- Develop feather-light laptops

FIND OUT MORE

Explore more about engineering. The following Web sites offer fun projects, videos of engineers doing innovative work, and videos of real-world STEM connections:

- NASA eClips at nasa.gov/audience/foreducators/nasaclips
- Engineer Your Life at engineeryourlife.org
- Discover Engineering at discoverengineering.org
- *Design Squad* at pbs.org/designsquad

WHAT'S ENGINEERING?

"Engineers get to imagine the future and design for it."

Marisa Wolsky, Design Squad
Executive Producer

"Engineering is about thinking through problems, finding solutions, and helping people."

Daniele Lantagne,
environmental engineer

"The best part of being an engineer is the creativity that's involved and the satisfaction that comes from solving hard problems."

Jananda Hill,
computer-science engineer

"Every day I see things that could be made better by just applying some good engineering know-how."

Jessica Miller,
biomedical engineer



Photo: Lauren Feinberg

You can be the one to help a young person discover just how cool engineering is.

ONLINE RESOURCES FROM NASA AND DESIGN SQUAD

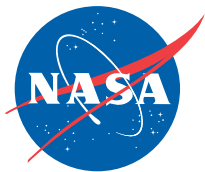

FROM NASA

Want more ways to extend and enrich your kids' experiences of space exploration and living on the moon?

Tap **NASA's vast collection** of moon-related animations, videos, interactives, and educator guides at [NASA.gov](https://www.nasa.gov).

- Engineering Design Challenges (Grades 5–12)
- Exploring the Moon Teacher's Guide (Grades 4–12)
- Field Trip to the Moon Educator Guide (Grades 5–8)
- Field Trip to the Moon Companion Guide (Grades 5–8)
- Field Trip to the Moon Informal Educator Guide (informal settings)
- Lunar Nautics: Designing a Mission to Live and Work on the Moon Educator Guide (Grades 5–8)
- Lunar Plant Growth Chamber Educator Guide (Grades 9–12)
- Moon Munchies Educator Guide (Grades K–4)
- Packing Up for the Moon (Grades 5–8)

Also, get games, activities, and the *Exploring the Moon* Teacher's Guide from the Lunar Reconnaissance Orbiter Web site at lro.gsfc.nasa.gov/education.html.



FROM DESIGN SQUAD

Extend and enrich your kids'

Design Squad experiences. Find the following resources at pbs.org/designsquad.

- **Watch *Design Squad***—Get all the episodes online and view video clips of engineers who showcase diverse, creative career paths in engineering.
- **Get more hands-on, open-ended engineering challenges**—Each comes with leader notes and reproducible challenge sheets in English and Spanish.
- **Host *Design Squad* clubs and events**—Get the Event Guide to help you host fun-filled engineering events for kids and families. It contains five challenges with reproducible activity sheets in English and Spanish, a list of sources for materials, a planning checklist, and an evaluation form. The Web site also has downloadable signs, iron-on T-shirt transfers, and volunteer certificates.
- **Stay informed**—Sign up for an E-newsletter about the show, Web site, resources, events, and trainings.

FIT THE GUIDE'S CHALLENGES INTO ANY PROGRAM

Classrooms, afterschools, clubs, and other ongoing programs

On the Moon challenges provide fun ways for kids to apply the design process and core science concepts. Each activity is distinct, offering kids variety, letting them unleash their creativity, and helping them practice important skills, such as problem solving, teamwork, and critical thinking.

Events and other one-time occasions

Take *On the Moon* activities to a museum, library, mall, or university and spark kids' interest and confidence in engineering with a lively, fun-filled event. The first two challenges are especially good for events like science and engineering days—they use simple, readily available materials, and are open ended, with multiple solutions that engage a wide variety of ages and ability levels.

LAUNCH IT

LEADER NOTES

The Challenge

Design and build an air-powered rocket that can hit a distant target.

In this challenge, kids follow the engineering design process to: (1) design and build a rocket from a straw; (2) launch their rocket using a balloon; (3) improve their rocket based on testing results; and (4) try to consistently hit a target with their rockets.

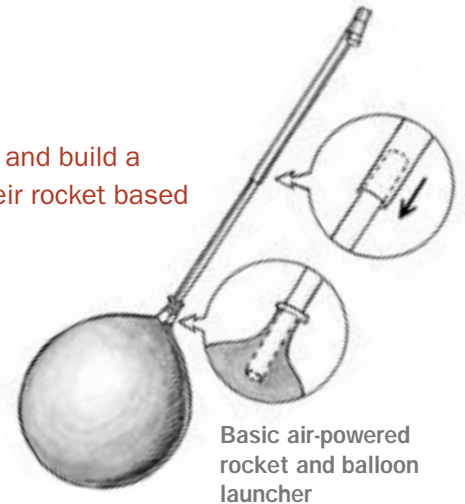

Basic air-powered rocket and balloon launcher

1 Prepare ahead of time

- Read the challenge sheet and leader notes to become familiar with the activity.
- Gather the materials listed on the challenge sheet.
- Build a sample rocket and launcher.

2 Introduce the challenge (10 minutes)

- **Tell kids about the role rockets play in getting people and equipment to the moon.**
To get to the moon, NASA uses a rocket. A rocket is basically a huge engine that lifts things into space. Sometimes rockets carry people (called astronauts) into space. Sometimes, they carry NASA's space shuttle, a satellite, or other piece of space equipment. Today you'll make a rocket out of straw that uses air power to hit a target. By testing your rocket, you'll find ways to make it work better. Improving a design based on testing is called the engineering design process.
- **Show kids your sample rocket and launcher. See if they can name the main parts.**
*The large column that makes up most of the rocket is called the **body**. If you add wing-like sheets to the lower end of the body, they are called **fins**. The small capsule that sits atop the body is the **nosecone**. The nosecone is where the astronauts sit or where NASA stows the satellites or equipment it sends into space.*

3 Brainstorm and design (10 minutes)

Distribute the challenge sheet. Discuss the questions in the Brainstorm and Design section.

- **What are some ways you can change a rocket?** (*Kids can change: the length of the straw; the straw's weight; the weight and shape of the nosecone; the number and position of fins; the amount of air in the balloon; and how they release the air.*)
- **How will adding weight to the straw's nose or having fins affect how it flies?** (*Adding weight to the straw's nose or placing fins near the back can help it fly straighter.*)
- **When you launch your straw rocket, how does the launch angle affect where it lands?**
(Launching a rocket straight up sends it high but not far; straight out makes it fall quickly to the floor. This could be a great opportunity to explore angles with kids.)

4 Build, test, evaluate, and redesign (30 minutes)

Help kids with any of the following issues. For example, if the straw rocket:

- **sticks to the launch straw**—*The straw might have become wet as kids blew through it. If so, have them wipe it. Also, check that the balloon is inflated enough.*

- **veers off course**—Add fins, either at the rear or middle of the rocket.
- **lands on its side instead of nose first**—Add a little weight to the nose.
- **doesn't go far**—Blow up the balloon more; reduce the straw's weight; change the tilt of the launch; change the length of the straw rocket—a longer straw gets a bigger blast of air, which pushes on the straw for a longer time, speeding it up and sending it farther.

5 Discuss what happened (10 minutes)

Have the kids show each other their rockets and talk about how they solved any problems that came up. Emphasize the key ideas in today's challenge by asking:

- **What features of your design helped your rocket hit the target?** (Key factors include the rocket's weight, launch angle, ability to fly straight, and the balloon's pressure.)
- **After testing, what changes did you make to your rocket and launcher?** (Answers will vary.)
- **How did changing the launch angle affect how your rocket flew?** (Steep launch angles send a rocket high into the air but not far horizontally. Shallow launch angles send a rocket far horizontally but not high.)
- **What's an example of potential (stored) and kinetic (motion) energy?** (Potential energy: Energy is stored when the balloon is inflated and the material is stretched, and when the rocket is higher in the air. Kinetic energy: Stored energy is changed into motion energy when the pressurized air inside the balloon rushes out and when the rocket moves.)
- **After reading the stories on the back of the handout, what do you think about traveling by rocket?**
(Kids see that rockets can travel huge distances, travel fast, and need a lot of force to get going.)

EXTEND THE CHALLENGE

See how far kids' rockets can go.

- Have kids test how far their rocket goes per breath of air used to fill the balloon. For example, have them fill the balloon with three breaths of air, launch the rocket, and measure how far it travels from its launch point. Repeat with five, seven, and nine breaths. Have kids plot distance traveled against number of breaths. (Note: In each round, keep the launch angle constant.)
- Have kids experiment with different launch angles by using a protractor to position a book cover or sheet of cardboard at a series of various angles, such as 30, 45, 60, and 90 degrees. Have them launch their rockets and compare how far they go.

CURRICULUM CONNECTIONS

Launch It ties to the following concepts commonly covered in science, math, and technology curricula. For a list of education standards supported by the activity, see pages 37 and 38.

- **Potential and kinetic energy**—Blowing up a balloon stretches the rubber, which stores energy as potential energy. When the pressurized air inside the balloon rushes out, the potential energy changes to motion energy (kinetic energy), making the rocket move.
- **Distance-angle relationships of an object in flight**—By launching rockets at different angles, kids will see that the travel distance and shape of the flight path change.
- **Path of a moving object**—During flight, the rocket follows a trajectory, which is a curved path.
- **Measurement**—Kids measure launch angles and the distance traveled by the rocket.

LAUNCH IT

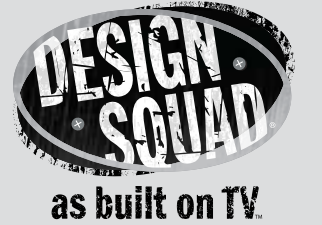
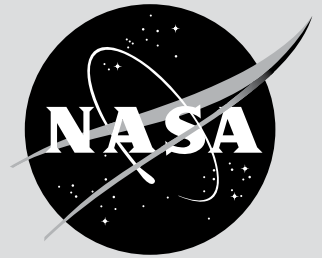

Going to the moon? You'll need a rocket. The rockets NASA sends to the moon go up to 18,000 miles (29,000 km) per hour. But it still takes about three days to get there. So, sit back, relax, and enjoy the view.

WE CHALLENGE YOU TO...

...design and build an air-powered rocket that can hit a distant target.

BRAINSTORM AND DESIGN

Think about things that might affect how your air-powered rocket flies.

- How long will your rocket be?
- How many paper fins will your straw rocket have—0, 2, or more?
- How will adding weight to the straw's nose or having fins affect how it flies?
- When you launch your straw rocket, how does the launch angle affect where it lands?

BUILD

1. **First, build a balloon-powered launcher.** Slide 1–2 inches (3–5 cm) of the thin straw into a balloon. Make a tight seal by taping the balloon to the straw.
2. **Next, build a straw rocket.** Use the wide straw for the rocket. Seal one end. Either plug it with clay or fold the tip over and tape it down.
3. **Now launch your rocket.** Blow into the thin straw to blow up the balloon. Slide the wide straw onto the thin straw. Aim. Launch!

MATERIALS (per rocket)

- balloon
- small lump of clay
- paper
- 1 wide straw
- 1 thin straw that fits inside the wide straw
- tape
- target (box lid or paper with a bull's-eye drawn on)
- scissors

TEST, EVALUATE, AND REDESIGN

Set up a target. Stand 5 feet (1.5 m) away and try to hit it with your rocket. Can you make your rocket hit the target every time? Try these things if your rocket:

- **falls quickly to the ground**—Reduce the weight.
- **misses the target**—Launch it at a different angle.
- **won't fly straight**—See if fins make a difference. Also, try adding weight to the rocket's nose.
- **sticks to the launch straw**—Make sure the launch straw is dry. If it isn't, wipe it dry. Also, try blowing up the balloon more.

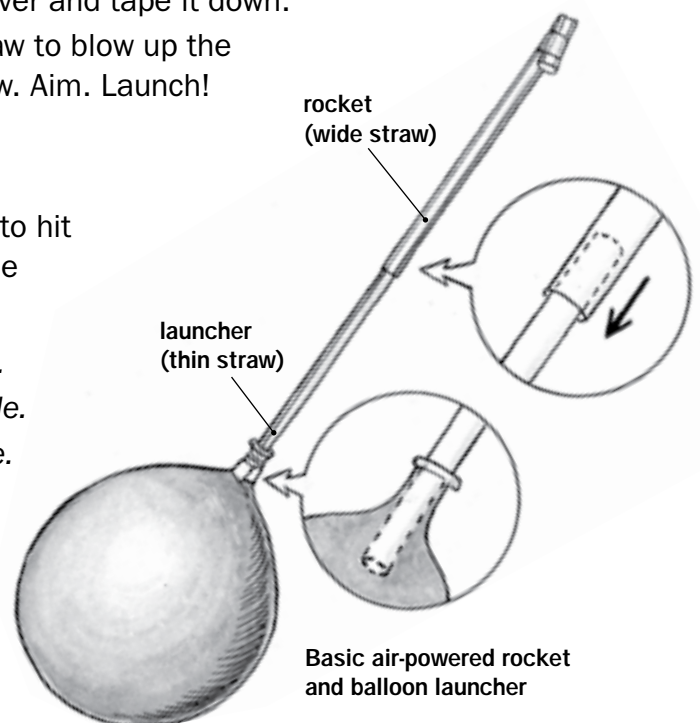

Basic air-powered rocket and balloon launcher

TAKE ME TO THE MOON

It's been over 25 years since NASA's been to the moon. But that's about to change. Soon, two spacecraft—the Lunar Reconnaissance Orbiter and the Lunar Crater Observation and Sensing Satellite—will be on their way. Compared to a rocket, these spacecraft are tiny—together they're the size of a school bus and only about as heavy as a medium-sized elephant. Still, it's not easy to get them into space. The rocket carrying them will burn about 90,000 gallons (341,000 liters) of high-tech fuel in the first few seconds of the trip. When they say, "Blast off," they really mean it.

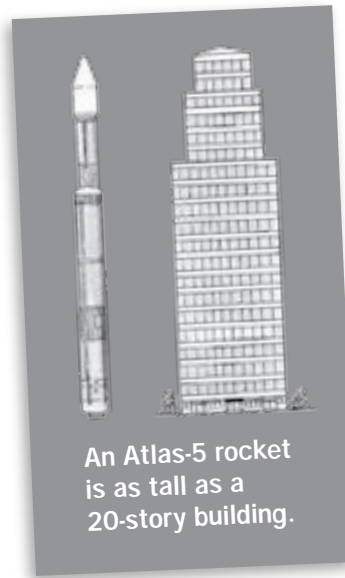

An Atlas-5 rocket is as tall as a 20-story building.



Check out NASA's moon missions at moon.msfc.nasa.gov.

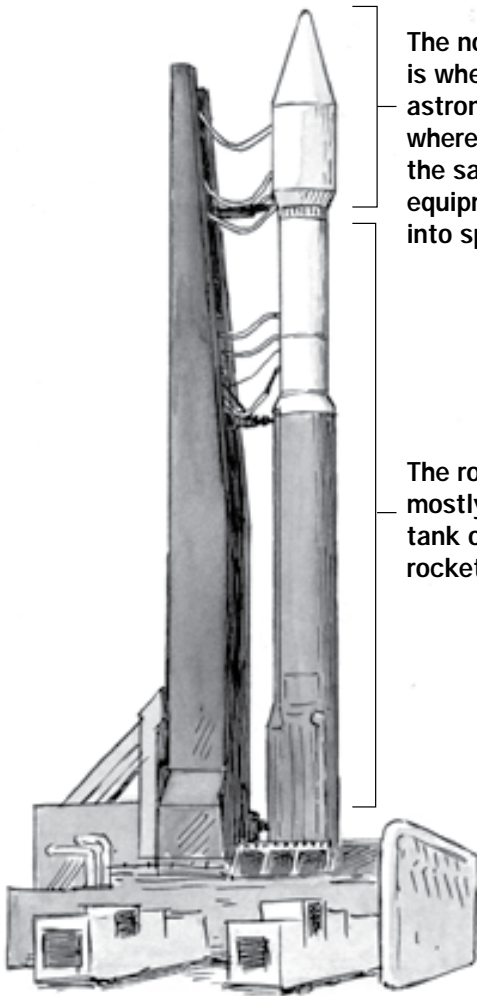

The nosecone is where the astronauts sit or where NASA stows the satellites or equipment it sends into space.

The rocket body is mostly a huge fuel tank on top of rocket engines.

MY, HOW THINGS HAVE CHANGED!

Today's rockets travel fast, far, and for a long time. One rocket, called Voyager 1, has been traveling for more than 30 years and is now about 10 billion miles (16 billion km) from Earth! Quite a change from the early days. In 1926, Robert Goddard designed and built the first liquid-fuel rocket. It flew for only 2½ seconds and went just 41 feet (12.5 m). Talk about improving a design!

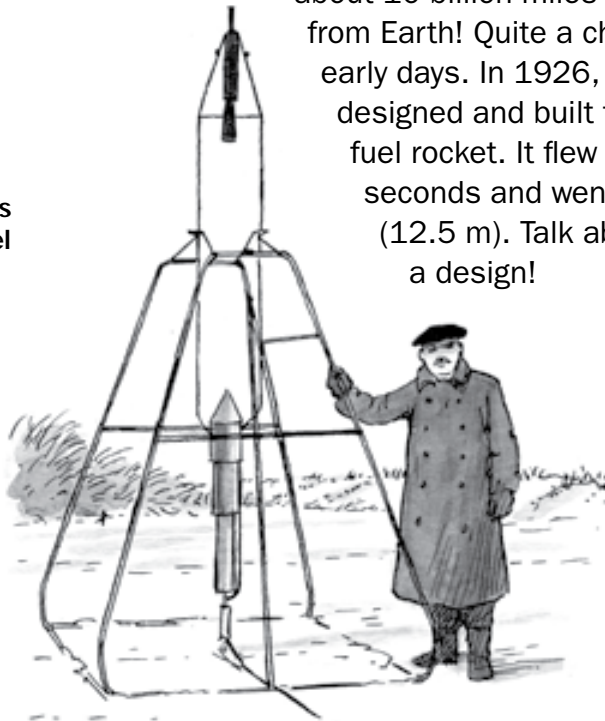

Robert Goddard and the first liquid-fuel rocket

Watch DESIGN SQUAD on PBS or online at pbs.org/designsquad.



Major funding for *Design Squad* provided by



A private corporation funded by the American people



Education

Additional funding for *Design Squad* provided by



Design Squad is produced by WGBH Boston. *Design Squad*, AS BUILT ON TV, and associated logos are trademarks of WGBH. All rights reserved. This NASA/*Design Squad* challenge was produced through the support of the National Aeronautics and Space Administration (NASA).



For more information about NASA missions and educational programs, visit nasa.gov.

TOUCHDOWN

LEADER NOTES

The Challenge

Design and build a shock-absorbing system that will protect two “astronauts” when they land.

In this challenge, kids follow the engineering design process to: (1) design and build a shock-absorbing system out of paper, straws, and mini-marshmallows; (2) attach their shock absorber to a cardboard platform; and (3) improve their design based on testing results.

1 Prepare ahead of time

- Read the challenge sheet and leader notes to become familiar with the activity.
- Gather the materials listed on the challenge sheet.
- Fold an index card into a spring (see illustration).

2 Introduce the challenge (5 minutes)

- **Tell kids why a spacecraft that can land gently is important for getting astronauts to and from the moon safely.**

NASA is looking for safe landing sites on the moon. Once they find one, they need to design and build a spacecraft that can land there without injuring astronauts or damaging the spacecraft. Today you’ll make a lander—a spacecraft that can land safely when you drop it on the floor. As you test, you’ll find ways to make it work better. Improving a design based on testing is called the engineering design process.

- **Show kids the spring made out of an index card.**

When you jump off a high step, you bend your back and knees to absorb some of the energy and break your fall. That’s what a shock absorber does—absorbs the energy of an impact. Soft things, like marshmallows, cotton balls, foam, and bubble wrap absorb shock well. You can also use paper, like this index card made into a spring by folding it like an accordion.

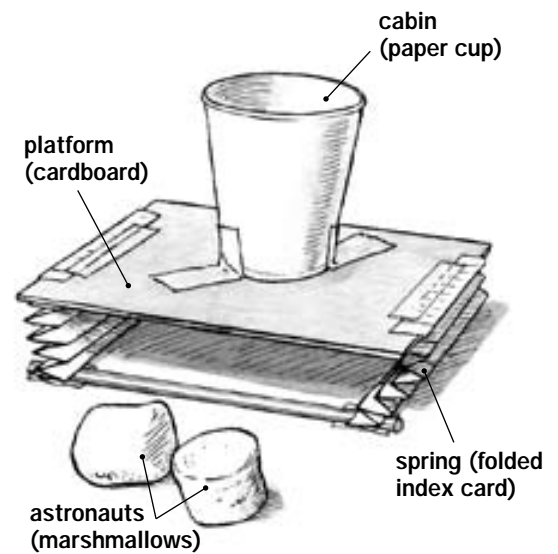

Sample lander

3 Brainstorm and design (10 minutes)

Distribute the challenge sheet. Discuss the questions in the Brainstorm and Design section.

- **What kind of shock absorber can you make from these materials to help soften a landing?** (*Mini-marshmallows can serve as soft footpads. Cards can be folded into springs. Straws can provide a flexible structure. Rubber bands can flex and hold things together.*)
- **How will you make sure the lander doesn’t tip over as it falls through the air?** (*Making the parts below the platform weigh more than the parts on the top helps the lander fall straight down. Also, it helps to evenly distribute the weight on top of the platform.*)

4 Build, test, evaluate, and redesign (35 minutes)

Help kids with any of the following issues. For example, if the lander:

- **tips over when it drops**—Move the cup slightly away from the side that’s tipping. Or, reposition the parts of the shock-absorbing system to better balance the weight.

- **bounces instead of landing softly**—Change the size, position, or the number of shock-absorbing parts. Kids can also add mini-marshmallows for landing-pad feet. Or, they can use marshmallows at key junctions in the lander’s frame to help absorb energy.

5 Discuss what happened (10 minutes)

Have the kids show each other their landers and talk about how they solved any problems that came up. Emphasize the key ideas in today’s challenge by asking:

- **What forces affected your lander as it fell?** *(It accelerated [sped up] as it fell due to the pull of gravity. Air also pushed on it, and this air resistance slowed it down.)*
- **After testing, what changes did you make to your lander?** *(Answers will vary.)*
- **Engineers’ early ideas rarely work out perfectly. How does testing help them improve a design?** *(Testing helps you see what works and what doesn’t. Knowing this lets you improve a design by fixing the things that aren’t working well or could work even better.)*
- **What did you learn from watching others test their landers?** *(Answers will vary. But in general, kids will see that there are many ways to successfully tackle a challenge.)*
- **The moon is covered in a thick layer of fine dust. How might this be an advantage? A disadvantage?** *(If the dust layer is soft, it would help cushion a landing. However, if it is too soft, a lander could sink into it and get stuck. Also, the lander’s rocket engine could send up clouds of dust, which could get into the machinery and cause it to jam or malfunction.)*

EXTEND THE CHALLENGE

- **Hold a “How High Can You Go?” contest.** Have kids drop their landers from two feet. Eliminate all landers that bounce out their “astronauts.” Next, raise the height to three feet. Continue in this fashion until a winner emerges. You can also increase the challenge by having kids add a third marshmallow “astronaut” to their cups.
- **Test springs of different sizes.** Have kids see if the number of folds in an index card makes a difference in the amount of force the spring can absorb. Have them fold index cards with two, four, and six folds. Have them test to see how much of a difference these different springs make in how softly a lander touches down.

CURRICULUM CONNECTIONS

Touchdown ties to the following concepts commonly covered in science, math, and technology curricula. For a list of education standards supported by the activity, see pages 38 and 39.

- **Potential and kinetic energy**—When the lander hits the surface, its motion (kinetic) energy is changed into stored (potential) energy, which gets stored in the shock absorbers.
- **Acceleration due to gravity**—The lander accelerates (speeds up) as it falls due to Earth’s gravitational pull.
- **Air resistance**—Air exerts a force on the lander as it falls, slowing it down.
- **Measurement**—Kids measure the various heights from which they drop the lander.

TOUCHDOWN

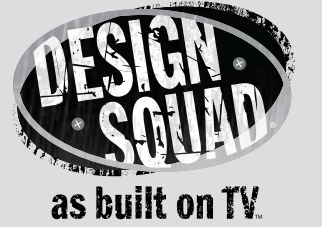
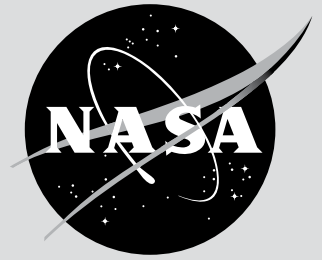

Landing on the moon is tricky. First, since a spacecraft can go as fast as 18,000 miles per hour (29,000 km/hour) on its way to the moon, it needs to slow way down. Then it needs to land gently. That lander has astronauts inside, not crash-test dummies. Easy does it!

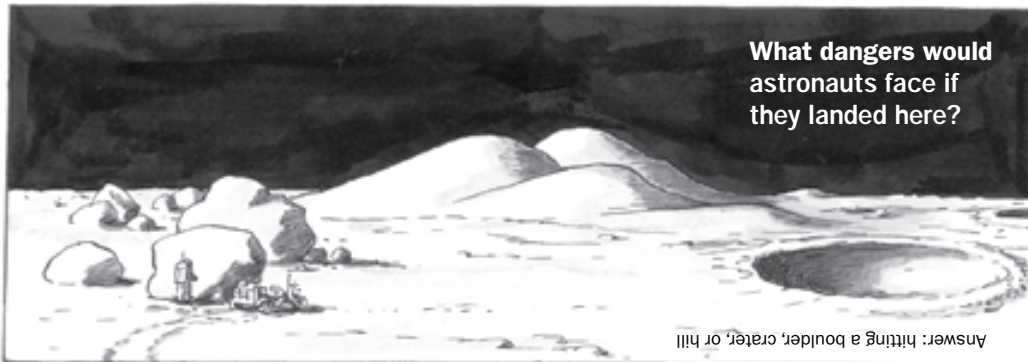

WE CHALLENGE YOU TO...

...design and build a shock-absorbing system that will protect two "astronauts" when they land.

BRAINSTORM AND DESIGN

Think about how to build a spacecraft that can absorb the shock of a landing.

- What kind of shock absorber can you make from these materials that can help soften a landing?
- How will you make sure the lander doesn't tip over as it falls through the air?

BUILD

- 1. First, design a shock-absorbing system.**
Think springs and cushions.
- 2. Then, put your spacecraft together.**
Attach the shock absorbers to the cardboard platform.
- 3. Finally, add a cabin for the astronauts.**
Tape the cup to the platform. Put two astronauts (the large marshmallows) in it. (NOTE: The cup has to stay open—no lids!)

MATERIALS (per lander)

- 1 piece of stiff paper or cardboard (approximately 4 x 5 in./10 x 13 cm)
- 1 small paper or plastic cup
- 3 index cards (3 x 5 in./8 x 13 cm)
- 2 regular marshmallows
- 10 miniature marshmallows
- 3 rubber bands
- 8 plastic straws
- scissors
- tape

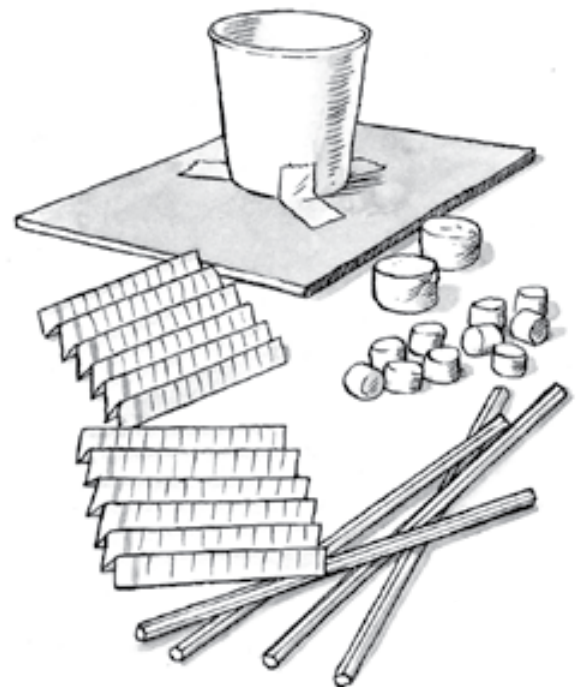

A lander under construction

TEST, EVALUATE, AND REDESIGN

Ready to test? Drop your lander from a height of one foot (30 cm). If the “astronauts” bounce out, figure out ways to improve your design. Study any problems and redesign. For example, if your spacecraft:

- **tips over as it falls through the air**—Make sure it’s level when you release it. Also check that the cup is centered on the cardboard. Finally, check that the weight is evenly distributed.
- **bounces the astronauts out of the cup**—Add soft pads or change the number or position of the shock absorbers. Also, make the springs less springy so they don’t bounce the astronauts out.

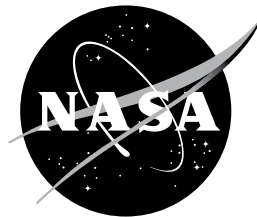

Check out NASA's moon missions at moon.msfc.nasa.gov.



THE COOLEST JOB AT NASA

When people asked Cathy Peddie what she wanted to do when she grew up, she would point at

the sky and say, “I want to work up there!” Now an engineer at NASA, she manages the Lunar Reconnaissance Orbiter (LRO) project. She calls it “the coolest job at NASA.” LRO will orbit the moon for at least a year and collect information to help NASA prepare for having people live and work there. Hear her describe the mission at: learners.gsfc.nasa.gov/mediaviewer/LRO.

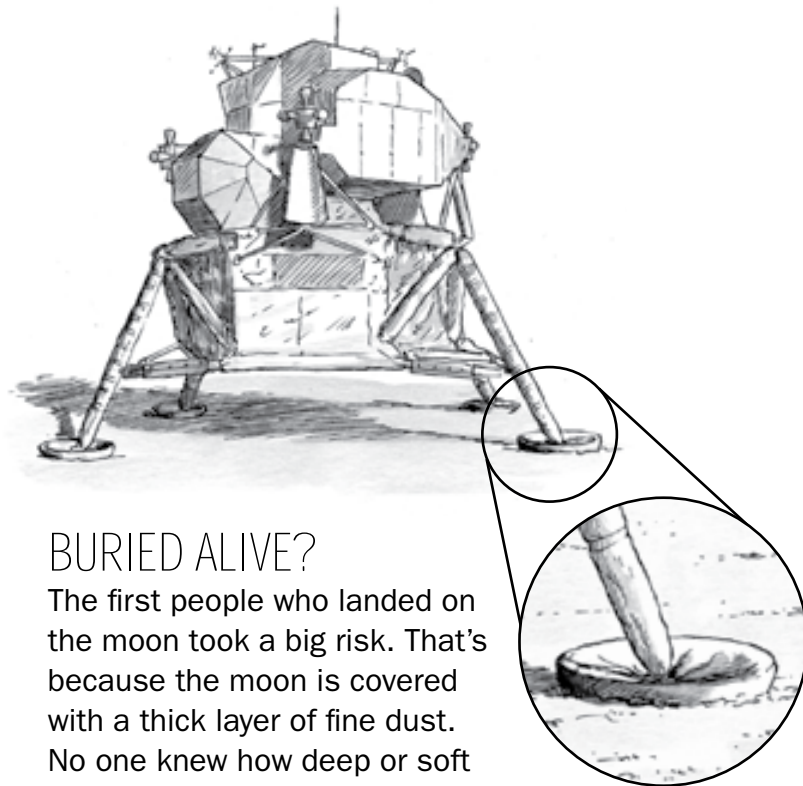

BURIED ALIVE?

The first people who landed on the moon took a big risk. That’s because the moon is covered with a thick layer of fine dust. No one knew how deep or soft this layer was. Would a spacecraft sink out of sight when it landed? Now we know—the layer is firm. In the picture, you can see that Apollo 11’s lander pads sank only about 2 inches (5 cm) into the dust. What a relief! This helped NASA figure out the kinds of shock absorbers and landing systems its spacecraft need.

Only 12 people have ever visited the moon. But someday soon NASA plans to have teams of astronauts living there for six months at a time.

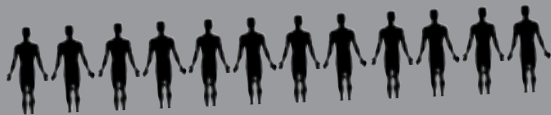

Watch DESIGN SQUAD on PBS or online at pbs.org/designsquad.



Major funding for *Design Squad* provided by



A private corporation funded by the American people



Education

Additional funding for *Design Squad* provided by



Design Squad is produced by WGBH Boston. *Design Squad*, AS BUILT ON TV, and associated logos are trademarks of WGBH. All rights reserved. This NASA/*Design Squad* challenge was produced through the support of the National Aeronautics and Space Administration (NASA).



For more information about NASA missions and educational programs, visit nasa.gov.

ROVING ON THE MOON

LEADER NOTES

The Challenge

Build a rubber band-powered rover that can scramble across the room.

In this challenge, kids follow the engineering design process to: (1) design and build a rover out of cardboard; (2) figure out how to use rubber bands to spin the wheels; and (3) improve their design based on testing results.

1 Prepare ahead of time

- Read the challenge sheet and leader notes to become familiar with the activity.
- Gather the materials listed on the challenge sheet.
- Build a sample rover.

2 Introduce the challenge (5 minutes)

- **Tell kids some of the ways rovers will be used on the moon.**

NASA plans to land astronauts on the moon by the year 2020. The astronauts will need moon cars—called rovers—to drive across the moon’s surface, carry supplies, help build their outpost, and explore the area. Today you’ll build and test a rubber band-powered rover.

- **Show kids your sample rover. Tell them:**

This is a prototype of a rover, just like the one you are going to build. Prototypes are used all the time in engineering. They give you a basic design to build, test, and evaluate. Once you understand a design’s strengths and weaknesses, you can then find ways to improve it. Today, for example, as you test your rover prototype, you’ll find ways to make it work better. Improving a design based on testing is called the engineering design process.

3 Brainstorm and design (10 minutes)

Get kids thinking about the rover prototype. Ask:

- **What do we have to do to make the rover move?** (*Turn the wheels to wind up the rubber band. Place the rover on the floor. Then let go. NOTE: Depending on the direction you wind the wheels, the rover can move either forward or backward.*)
- **How can you make different kinds of wheels?** (*Kids can make different-sized wheels by cutting larger or smaller squares or make different-shaped wheels by trimming the squares. NOTE: Square wheels offer two advantages: they’re quick to make, and it’s easy to find the exact center by drawing diagonal lines. The center is where the lines cross.*)
- **How do you think square wheels affect how the rover moves across the floor?** (*The points of the squares dig into soft surfaces, such as rugs, sand, or grass. This improves traction—the ability to grip a surface—and helps prevent the wheels from spinning out. Since the moon is covered in a thick layer of fine dust, good traction is essential, especially going up and down hills.*)

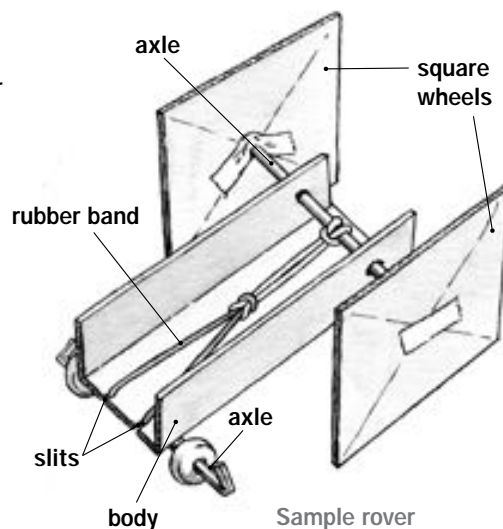

- **What are different ways you can use rubber bands to power a rover?** *(Kids can change the number of rubber bands. Sometimes, a rubber-band chain works better than just one rubber band. Also, kids can cut open a rubber band and use the single strand of elastic.)*

4 Build, test, evaluate, and redesign (35 minutes)

Distribute the challenge sheet and have kids get started. Help them with any of the following issues. For example, if the rover:

- **wheels don't turn freely**—*Make sure they are firmly attached to the axles and are parallel to the sides. Also make sure the holes punched in the cardboard body are directly across from one another and are large enough to allow the pencil to turn easily.*
- **won't travel in a straight line**—*Make sure the axles are straight and the front wheels are the same size. If one wheel is smaller, the rover will turn in that direction.*
- **doesn't go far**—*Have kids wind up the wheels more. Also have them try using larger wheels. Bigger wheels have a larger perimeter (outer edge). As a result, one rotation of a large wheel will move the rover farther than one rotation of a small wheel.*
- **wheels spin out**—*Wheels spin in place when a rubber band delivers too much power at once or when there's not enough friction between the wheels and ground. To increase friction, have kids add weight over the drive wheels or add more wheels to each axle. To reduce how quickly a rubber band releases its power, kids can reduce tension by using a rubber-band chain or by cutting open a rubber band and using only a single strand of elastic.*

5 Discuss what happened (10 minutes)

Have the kids show each other their rovers and talk about how they solved any problems that came up. Emphasize the key ideas in today's challenge by asking:

- **What kinds of Earth vehicles are similar to rovers?** *(Snowmobiles, tanks, dune buggies, and all-terrain vehicles are similar. They all have good traction, are very stable, have powerful engines, and don't require a roadway.)*
- **The challenge sheet gave you a rover prototype to get started with. How did starting with a prototype help you end up with a rover that worked really well?** *(With a prototype, kids can quickly see what's working and what isn't. They then know where to make improvements.)*
- **How did friction affect your rover?** *(To be efficient, there needs to be minimal friction between the axle and the axle hole in the cardboard. To move, there needs to be lots of friction between the wheels and the ground.)*
- **How did the rover use potential and kinetic energy?** *(Potential energy is energy that is stored. Kinetic energy is the energy of motion. Winding the front wheels increased the amount of potential energy stored by the rubber band. When the wheels spin, this potential energy is turned into kinetic energy, and the axle and wheels turn.)*
- **How does the story about rover wheels on the back of the handout make you think about what it takes to design a wheel that can work on the moon?** *(Kids see that engineers face special design challenges when developing equipment to be used in space.)*

EXTEND THE CHALLENGE

- **Graph how increased potential energy affects distance traveled.** Kids can measure how far a rover travels as its rubber band is increasingly tightened. Have them turn the wheels 3, 6, 9, and 12 times and then measure the distance the rover travels each time. On a graph, have them plot the number of wheel rotations vs. the distance traveled. (*Winding the wheels more increases the potential energy, which should increase the distance.*)
- **Determine the effect of friction.** Have kids wind up the wheels a set number of times and measure the distance their rover travels. Then have them minimize friction in the wheel-axle system. For example, they can line the axle holes with a material such as aluminum foil, then wind up the wheels the same number of times and retest their rovers. Use the following formula to calculate the percent increase in distance traveled.

$$\text{Percent Increase} = \frac{(\text{Distance modified rover traveled}) - (\text{Distance basic rover traveled})}{\text{Distance basic rover traveled}} \times 100$$

- **Test the effect of wheel shape.** Starting with square wheels, have kids measure how far their rovers travel. Then have them snip off the corners of their wheels and test again. Make sure they wind up the wheels the same number of turns. How did the distance change? Did the wheels spin out? Test square, octagonal, and round wheels.

CURRICULUM CONNECTIONS

Roving on the Moon ties to the following concepts commonly covered in science, math, and technology curricula. For a list of education standards supported by the activity, see pages 39 and 40.

- **Friction**—To move, rovers need friction between the wheels and ground. To be efficient, rovers need minimal friction between the axle and rover body.
- **Newton's 2nd Law (Force = Mass x Acceleration)**—The more force the rubber band applies to the wheels and the less mass there is to move, the faster the rover will accelerate.
- **Potential and kinetic energy**—When kids wind up a rover's wheels, the rubber band stores energy as potential energy. As the wheels spin, the potential energy is changed to motion (kinetic) energy.
- **Measurement**—Kids measure how far their rovers traveled.

ROVING ON THE MOON

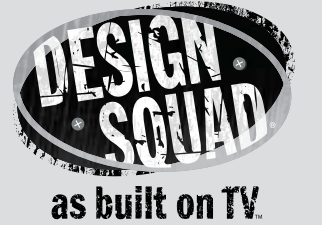
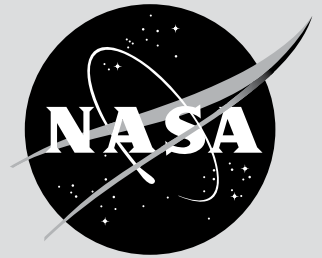

Can you imagine driving an all-terrain vehicle (ATV) on the moon? NASA can. It's building a fleet of ATVs (called rovers). Some can be driven by astronauts. Others are remote-controlled. All of them can handle the moon's dusty, rugged terrain. Talk about off-road adventure!

WE CHALLENGE YOU TO...

...design and build a rubber band-powered rover that can scramble across the floor.

BUILD

- 1. First, you have to make the body.** Fold the cardboard into thirds. Each part will be about 2 inches (5 cm) across. Fold along (not across) the corrugation (the tubes inside a piece of cardboard).
- 2. Then, make the front wheels.** On the two 5-inch (13-cm) cardboard squares, draw diagonal lines from corner to corner. Poke a small hole in the center (that's where the lines cross). On the body, poke one hole close to the end of each side for the axle. Make sure the holes are directly across from each other and are big enough for the pencil to spin freely.
- 3. Now attach the front wheels.** Slide the pencil through the body's axle holes. Push a wheel onto each end. Secure with tape.
- 4. Next, make the rear wheels.** Tape the straw under the back end of the rover. Slip a candy onto each end. Bend and tape the axle to stop the candies from coming off.
- 5. Finally, attach the rubber band.** Loop one end around the pencil. Cut small slits into the back end of the body. Slide the free end of the rubber bands into the slits.

MATERIALS (per rover)

- corrugated cardboard body (6-inch/15-cm square)
- 2 corrugated cardboard wheels (5-inch/13-cm square)
- 1 sharpened round pencil
- 2 rubber bands
- ruler
- tape
- 2 round candies (the hard, white, mint ones with a hole in the middle)
- 1 plastic drinking straw
- scissors

TEST, EVALUATE, AND REDESIGN

Test your rover. Wind up the wheels, set the rover down, and let it go. Did everything work? Can you make your rover go farther? Engineers improve their designs by testing them. This is called the design process. Try redesigning the wheel setup or rubber band system. For example, if:

- **the wheels don't turn freely**—
Check that the pencil turns freely in the holes. Also, make sure the wheels are firmly attached and are parallel to the sides.

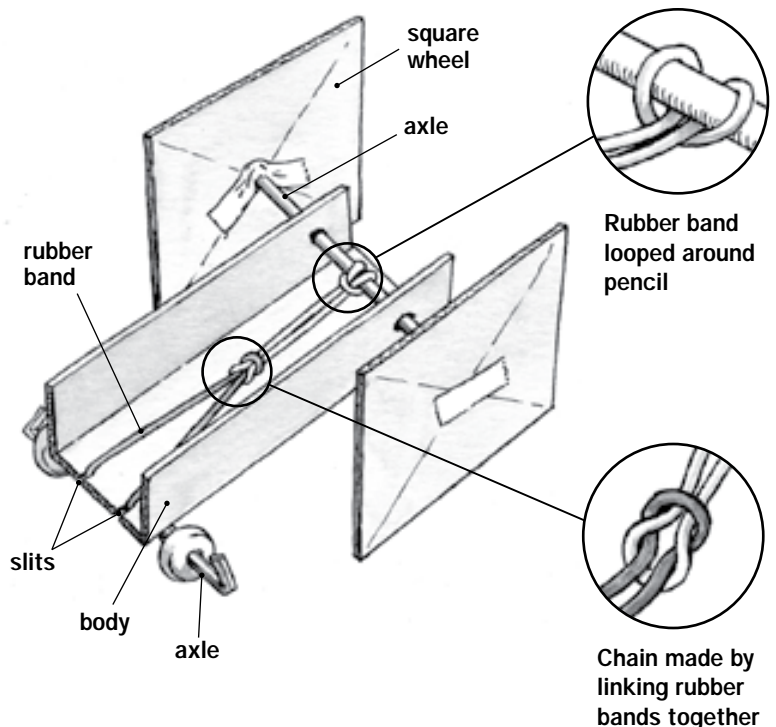

- **the rover doesn't go far**—Wind up the wheels more. Try wheels of different sizes or shapes. Or, add another rubber band or use a rubber-band chain.
- **the wheels spin out**—Add weight above the square wheels; put more wheels on the pencil; use bigger wheels; or cut open a rubber band and use only a single strand of elastic.
- **the rover won't travel in a straight line**—Check that the pencil is straight and the front wheels are the same size.

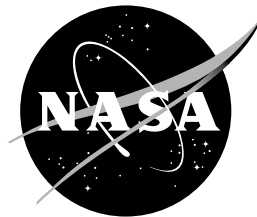

Check out NASA's moon missions at moon.msfc.nasa.gov.

CUSTOM WHEELS

The moon doesn't have an atmosphere—there's no air there! So air-filled tires like the ones on a bike or car would explode—the air inside would push through the tire to escape into outer space (where there's no air to push back against the walls of the tire). Imagine you're a NASA engineer who has to design a tire that:

- works in space, where there's no atmosphere
- withstands extreme hot and cold temperatures—on the moon, they range from roughly 250° to -250° Fahrenheit (121° to -157° Celsius)
- weighs 12 pounds (5.5 kg), which is half the weight of an average car tire
- won't get clogged with the fine dust that covers the moon

Despite these challenges, engineers designed a tire that worked perfectly when it was used on the moon. It's made of thin bands of springy metal. That helps it be lightweight, have good traction, and work at any temperature the moon can throw

at it. Plus, it flexes when it hits a rock, and it doesn't need to be pumped up.

Dependability is important. There's no roadside service when you're on the moon, 250,000 miles (400,000 km) from home.

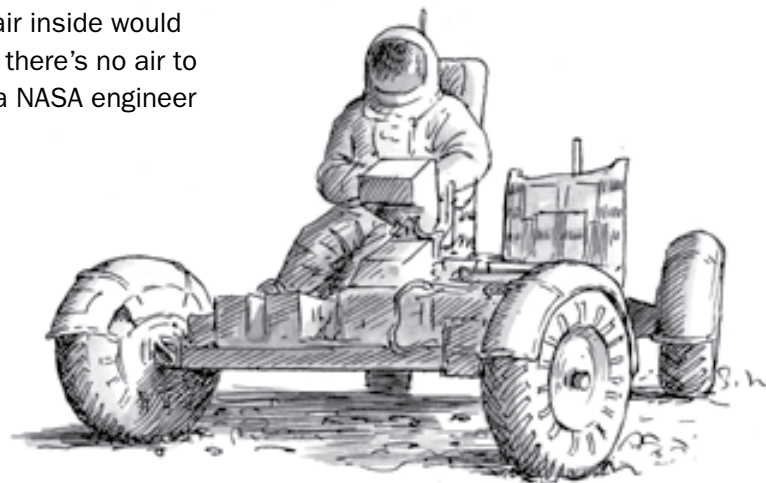

RIDE IN "STYLE"?

A rover may not be the hottest-looking vehicle around, but with a price tag of over ten million dollars, it's one of the most expensive. And it sure is convenient to bring along. Rovers can be folded and stored in a landing module the size of a small room. Look at the picture of the rover. Which features are also found on cars designed for use on Earth?

Answers: Chassis, wheels, fenders, motor, seats, seat belts, antenna, battery, camera (some cars), and steering controls.

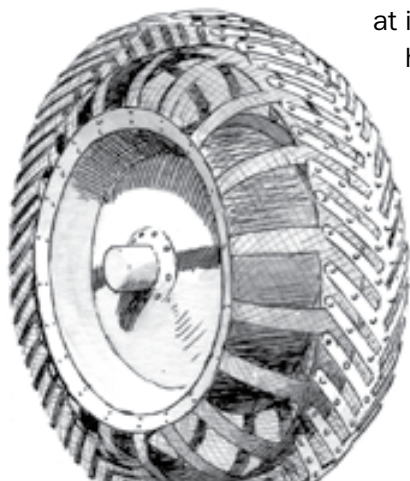

The farthest trip anyone has ever taken on the moon with a rover is 2.8 miles (4.5 km).

Watch DESIGN SQUAD on PBS or online at pbs.org/designsquad.



Major funding for *Design Squad* provided by



Additional funding for *Design Squad* provided by



Design Squad is produced by WGBH Boston. *Design Squad*, AS BUILT ON TV, and associated logos are trademarks of WGBH. All rights reserved. This NASA/*Design Squad* challenge was produced through the support of the National Aeronautics and Space Administration (NASA).



For more information about NASA missions and educational programs, visit nasa.gov.

HEAVY LIFTING

LEADER NOTES

The Challenge

Design and build a crane and see how heavy a load it can lift.

In this challenge, kids follow the engineering design process to:

- (1) design and build a crane out of cardboard;
- (2) figure out ways to reinforce the arms so they don't collapse under a heavy load;
- (3) build a crank handle;
- and (4) improve their cranes based on the results of their testing.

1 Prepare ahead of time

- Read the challenge sheet and leader notes to become familiar with the activity.
- Gather the materials listed on the challenge sheet.
- Build a simple crane arm out of a ruler, pencil, and string.

2 Introduce the challenge (5 minutes)

- **Tell kids some of the ways cranes will be used on the moon.**

At a lunar outpost, astronauts will need machines to build structures and move materials. One of those machines will be a crane. You've probably seen cranes lifting materials and moving them around a construction site. Cranes have a long arm, which holds a cable with a hook on the end. Whether they're on Earth or the moon, cranes have to be strong to lift heavy loads without breaking.

- **Show kids the simple crane arm you built. Then say:**

Today you'll design and build a crane and test it by seeing how heavy a load it can lift. The arm of your crane will need a stiff beam, a cable, and something to wind up the cable. Here's a simple model showing how the different parts work together. In your crane, you might use one cardboard strip for the arm. But you could also use two or even three strips. As you test, you'll find ways to make it work better. Improving a design based on testing is part of the engineering design process.

3 Brainstorm and design (10 minutes)

Distribute the challenge sheet. Discuss the questions in the Brainstorm and Design section.

- **How will you keep the crane's arm from breaking off the box as it lifts a heavy load?** (*Attach the arm firmly to the box. Kids can cut slits in the box top and insert the cardboard strip[s]. They can also tape the end of the arm firmly to the box.*)

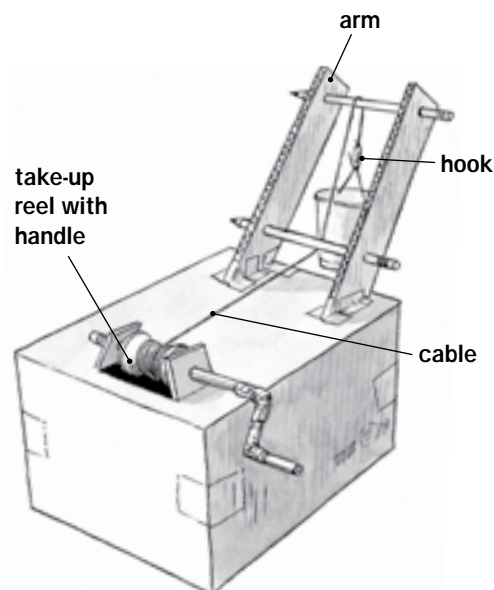

One crane design kids could build

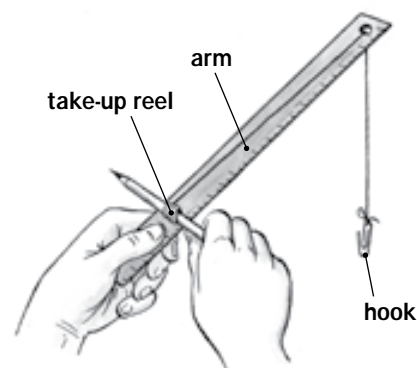

Simple crane arm

- **How will you stop a heavy load from pulling the arm to the left or right?** *(Kids can add extra pieces of cardboard above, below, and next to the arm as extra support. They can also run string from the top of the arm to the back and sides of the box.)*
- **How will you wind and unwind the cable so the hook can go up and down?** *(Kids will see that a pencil is the best item to use as a spool for the string. It's challenging, however, to build something to hold the pencil. One way is to make flaps—cut them out of the top of the box, bend them up, and poke the pencil through. Another way is to build a holder out of pieces of cardboard, which kids attach to the top of the box.)*

EXTENSION IDEA—ADD A HANDLE

On the handout, adding a crank handle is listed as optional. A crane can work without one, and the focus of the activity is on getting the arm to hold a heavy load. But having a crank handle is useful because it makes it easier to turn the pencil. It provides leverage, letting kids use less force to lift the load. Depending on your group, ask kids to add a crank handle as part of the basic design or suggest they do it as an extension.

4 Build, test, evaluate, and redesign (35 minutes)

Help kids with any of the following issues. For example, if:

- **the load rips the arm off the box**—*Attach the base of the arm securely to the box. Also have kids consider cutting slits in the box and sliding the arm into them. Secure the arm to the box by taping from both above and below.*
- **the arm fails when lifting a heavy weight**—*Start over with new cardboard. Also, have kids consider using multiple pieces of cardboard for an arm, either all together or spaced apart.*
- **the arm sways under a heavy load**—*Make sure the cable is in the center of the arm. Also, support the arm using string or strips of cardboard. Finally, if kids have used multiple cardboard strips to make an arm, check that both are equal length—a crane will tilt toward the shorter arm.*
- **it's hard to secure the take-up reel**—*Build something that holds the pencil, poke holes in the box, or cut flaps out of the top of the box and poke a pencil through the flaps.*

5 Discuss what happened (10 minutes)

Have the kids present their cranes and talk about how they solved any problems that came up. Emphasize the key ideas in today's challenge by asking:

- **What kinds of tasks might astronauts use a crane for?** *(In mining, cranes could lift minerals or ice into vehicles. Cranes could also be useful for assembling structures, such as buildings, satellite dishes, or solar panels.)*
- **Engineers' early ideas rarely work out perfectly. How does testing help them improve a design?** *(Testing helps you see what works and what doesn't. Knowing this lets you improve a design by fixing the things that aren't working well or could work better.)*
- **What force was affecting your crane, and how did the design of your crane deal with it?** *(A crane has to overcome gravity, which pulls down on the cable and arm. The arm and any extra supports, such as string or additional pieces of cardboard, help spread the forces equally. If all forces are equal and balance one another, the arm won't move.)*

- **How does the way you orient a cardboard strip affect how much it can hold?**

(A cardboard strip's strength depends on how it is oriented. When the strip is oriented vertically, like a wall, most of the cardboard resists the load's downward pull. This is the strongest orientation of the strip. In contrast, when a strip is oriented horizontally, like a ceiling, only a little cardboard resists the load's downward pull. This is the weakest orientation of the strip.)

- **How do the stories on the back of the handout help explain how NASA might use cranes on the moon?** *(Building an outpost and mining ice are both activities that require cranes.)*

EXTEND THE CHALLENGE

- **Have a “Heavyweight Champion” contest.** After kids finish building their cranes, take a basket or small bucket and add some weight. Have kids test their cranes. Eliminate all cranes that fail to lift the load. Add more weight and run another trial. How many cranes survived this round? Keep going in this manner until you have a winner.
- **Have a “Most Efficient Design” contest.** Identify the crane with the most efficient design. To determine this, put each crane on a scale and weigh it. Then, divide the weight of the heaviest load the crane lifted by the crane's weight. For example, if a crane lifted a load of six pounds and it weighs two pounds, you'd divide six by two to get three. This means that the crane lifted three times its own weight. The contest winner will be the crane with the highest number.
- **Lifting on the moon.** Ask students if it would be easier to lift an object on the moon, as compared to lifting it on Earth. *(It would be easier on the moon. This is because the force of gravity on the moon is one-sixth that of Earth's. So if a crane can easily lift a girder weighing one ton on Earth, then it can easily lift a six-ton girder on the moon.)*

CURRICULUM CONNECTIONS

Heavy Lifting ties to the following concepts commonly covered in science, math, and technology curricula. For a list of education standards supported by the activity, see pages 40 and 41.

- **Simple machines**—A crane uses three simple machines—a lever (the crank arm), a pulley (the arm's crosspieces), and a wheel and axle (the take-up reel). Because the crane is a combination of simple machines, it is called a complex machine.
- **Force and Newton's Third Law**—For a crane (or any type of structure) to be stable, all the forces—the pushes and pulls—acting on it must be balanced. Forces that are not balanced can cause movement (or even collapse). When a crane lifts a weight, its arm has many supports, guy wires, and struts to ensure that forces are spread equally. If all forces on the arm are equal and opposite, the arm won't move.
- **Measurement**—Kids measure the size of the parts of the crane and the distances between parts.

HEAVY LIFTING

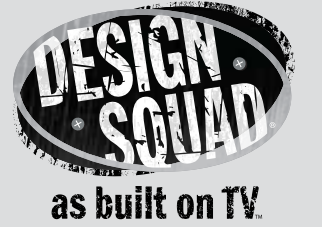
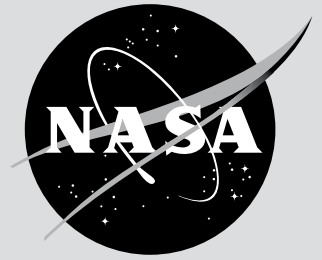

Living on the moon gets expensive fast. Shipping things from Earth costs about \$25,000 a pound! No wonder NASA plans to use materials found on the moon, such as calcium compounds to make cement and nitrogen compounds to fertilize crops. To mine materials like these, astronauts use cranes for digging and moving heavy or bulky loads.

WE CHALLENGE YOU TO...

... design and build a crane and see how heavy a load it can lift.

BRAINSTORM AND DESIGN

Think about things that might affect how heavy a load your crane can lift.

- How will you keep the crane's arm from breaking off the box as it lifts a load?
- How will you stop a heavy load from pulling the arm to the left or right?
- How will you wind and unwind the cable so the hook can go up and down?

BUILD

1. **First, make the arm.** The arm holds the string up and away from the crane's body. Use one, two, or all three cardboard strips to design your arm. Then attach it to the box.
2. **Next, make a take-up reel.** Figure out how to make a take-up reel that lets you shorten and lengthen the cable. (Optional: add a crank to turn the take-up reel.)
3. **Finally, add the string, hook, and cup.** Run the string through the arm. Attach it to the take-up reel and hook. Poke holes in each side of the cup near the rim. Make a handle for the cup and slip it onto the hook.

MATERIALS (per crane)

- cardboard box (shoebox size or bigger)
- 3 strips of corrugated cardboard (2 x 11 inches/5 x 28 cm)
- paper clip
- large paper cup
- 3 sharpened pencils
- scissors
- smooth string (e.g., fishing line or kite string)
- tape
- weights (e.g., batteries, pennies, marbles, or gravel)

TEST, EVALUATE, AND REDESIGN

Ready to test? Add weight to the cup. What's your crane's breaking point? Engineers improve their designs by testing them. The steps they follow are called the design process. Try some ideas and build an improved version. If:

- **the load rips the arm off the box**—Reinforce how it attaches. Add cardboard supports. Or cut slits in the box to hold the arm. Also, add tape to the top and underside of the box.
- **the arm crumples**—Start over with new cardboard. Also, use several pieces of cardboard for an arm, either all together or spaced apart.
- **the load pulls the arm to the side**—Use extra cardboard or string to add support.
- **the crank handle bends or slips**—If it slips, tape it or attach it more firmly. If it bends, reinforce it.

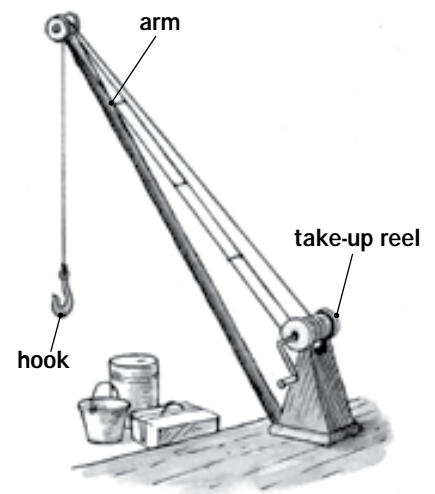

This hand-operated crane shows you the parts you'll need to include on your crane.

MORE PRECIOUS THAN GOLD?

The surface of the moon is drier than the driest desert on Earth. But under the surface, it might be a different story. NASA is sending several spacecraft to look for ice on the moon. Ice can be made into water, and water can be made into oxygen for breathing and fuel for the return home to Earth. If the spacecrafts find ice, one way to extract it is to use cranes.

NASA's Lunar Reconnaissance Orbiter (right) will study the moon's surface to find ice. If there's ice, cranes will help astronauts mine it.

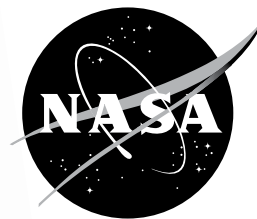
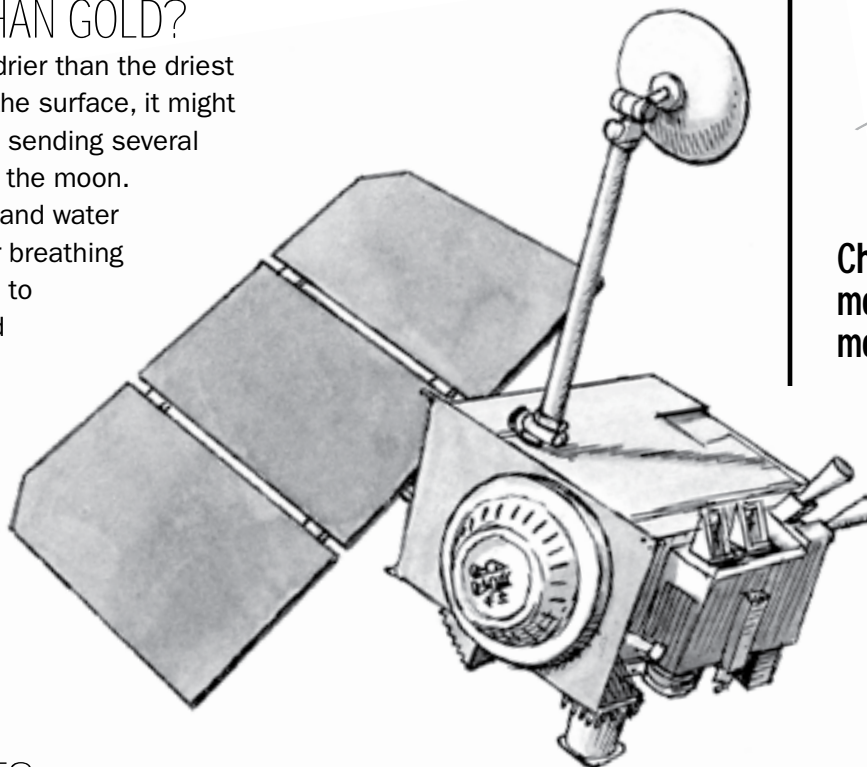

Check out NASA's moon missions at moon.msfc.nasa.gov.

HOME SWEET HOME?

NASA plans to send explorers to the moon for six-month-long stays. A lunar outpost will need to supply them with all they need to survive. Check out the drawing of what an outpost might look like. If you were going to spend six months on the moon, what would you take with you to make sure you'd be safe and comfortable? How many of the following items can you recognize?

- Landing pad
- Solar panels
- Satellite dish
- Loading dock
- Tools
- Crane
- Drill rig
- Living quarters
- Storage tanks (for oxygen, water, and fuel)
- Greenhouses (for growing plants)



Watch DESIGN SQUAD on PBS or online at pbs.org/designsquad.



Major funding for *Design Squad* provided by



A private corporation funded by the American people



Education

Additional funding for *Design Squad* provided by



NOYCE FOUNDATION

NORTHROP GRUMMAN Foundation



Design Squad is produced by WGBH Boston. *Design Squad*, AS BUILT ON TV, and associated logos are trademarks of WGBH. All rights reserved. This NASA/*Design Squad* challenge was produced through the support of the National Aeronautics and Space Administration (NASA).



For more information about NASA missions and educational programs, visit nasa.gov.

ON TARGET

LEADER NOTES

The Challenge

Modify a paper cup so it can zip down a line and drop a marble onto a target.

In this challenge, kids follow the engineering design process to: (1) modify a cup to carry a marble down a zip line; (2) attach a string to tip the cup; (3) test their cup by sliding it down the zip line, releasing the marble, and trying to hit a target on the floor; and (4) improve their system based on testing results.

1 Prepare ahead of time

- Read the challenge sheet and leader notes to become familiar with the activity.
- Gather the materials listed on the challenge sheet.
- Set up a sample zip line.
- Put a handle and paper clip on a cup (In other words, don't make a door or platform for the marble.)
- Optional: print a picture of the Lunar Crater Observation and Sensing Satellite (LCROSS) from the LCROSS Web site (lcross.arc.nasa.gov).

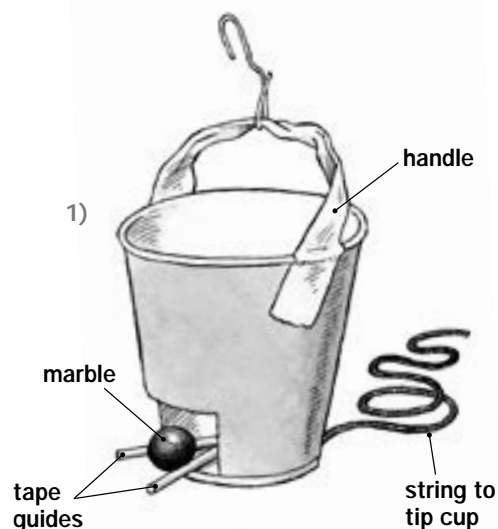

2 Introduce the challenge (5 minutes)

- **Tell kids how NASA will use the LCROSS spacecraft to search for water on the moon.**
To see if there's water on the moon, NASA is sending the Lunar Crater Observation and Sensing Satellite (LCROSS) hurtling into a crater near the moon's South Pole. The collision will send up a plume of dust and gas over 6 miles (10 km) high. Scientists will study this plume to see if there are any signs of water in it.

- **Show kids your zip line. Hang the cup on the zip line, using a hook made of a paper clip. Show kids how the cup travels down the zip line.**

Tell them:

Today you'll turn a paper cup into something that can zip down a line and drop a marble onto a target. Just as the success of LCROSS depends on hitting the crater exactly, success in today's activity depends on being able to hit the target accurately and consistently. As you test your design, you'll find ways to make it work better. Improving a design based on testing is called the engineering design process.

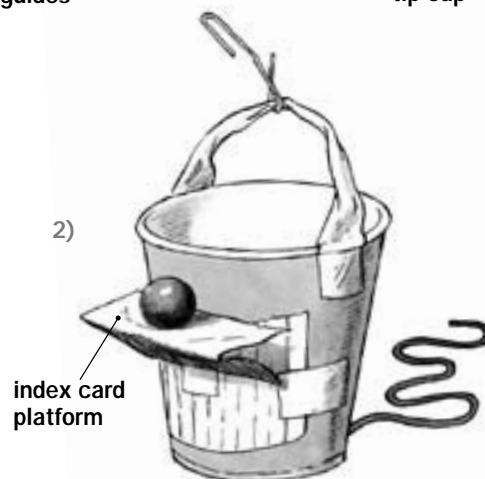

Sample marble carriers showing parts and two possible solutions: 1) an opening; 2) a platform

3 Brainstorm and design (10 minutes)

Distribute the challenge sheet. Discuss the questions in the Brainstorm and Design section.

- **How will you modify the cup so it can carry a marble down a zip line and also drop it onto a target?** (If the marble rides inside the cup, kids need to cut a door. If it rides outside the cup, kids need to make a platform, shelf, or holder. All systems need a way to tip the cup at the right instant.)
- **How will you remotely release the marble from the cup?** (Attaching a string on the uphill side of the cup, opposite the door or platform, will enable kids to tip the cup effectively.)
- **When do you need to launch the marble so that it will hit the target?** (Kids should stand near the top of the zip line, holding one end of the string. When the cup reaches the “drop zone,” kids should jerk the string. The marble will be ejected and fall toward the target. NOTE: When dropped, the marble keeps moving forward as it falls. Kids will need to factor in this forward motion as they decide when to release the marble.)

4 Build, test, evaluate, and redesign (35 minutes)

Help kids with any of the following issues. For example, if:

- **the cup goes slowly down the zip line**—Make sure the cup slides freely. Also, check the steepness of the zip line.
- **the remote release line is too short**—Kids should estimate where the “drop zone” on the zip line is and make the remote release line at least that long.
- **the marble doesn't eject cleanly**—Enlarge the opening or unblock the platform. Also place small rolls of tape in the bottom of the cup to guide the marble toward the opening.
- **the marble accidentally falls out of the cup or off the platform**—Adjust the tilt of the cup, if necessary. Also, kids can roll small tubes of tape to hold back the marble.
- **the marble misses the target**—Check that the door or platform doesn't interfere with the marble. Also, make sure kids are releasing the marble before the cup is above the target.

5 Discuss what happened (10 minutes)

Have kids show each other their modified cups and talk about how they solved any problems that came up. Emphasize the key ideas in today's challenge by asking:

- **What parts of your design were most important in getting the marble to hit the target?** (Getting the marble to eject cleanly from the cup and the timing of release are important.)
- **After testing, what changes did you make to your cup?** (Answers will vary.)
- **Describe the way your marble moved after you ejected it.** (It moved both downward and forward. This combination produced a curved path called a trajectory.)
- **Newton's First Law states that an object in motion continues in straight-line motion until acted on by a force. How did today's activity demonstrate Newton's First Law?** (As it traveled down the zip line, the marble built up speed. Once launched, it kept going at that speed until a force, such as gravity pulling it down or the floor stopping it, acted on the marble.)
- **How is your challenge similar to NASA's LCROSS mission to the moon?** (Both you and NASA devised a system that caused something to crash into a surface. Also, both setups have a remote triggering device, although LCROSS's is radio controlled. Finally, both the marble and the spacecraft have a forward and downward component to their motion.)

EXTEND THE CHALLENGE

- **Watch a video about LCROSS.** The LCROSS Web site has a four minute-long video that describes the mission and uses animation to show what happens when LCROSS strikes the moon's surface. Watch it online at: lcross.arc.nasa.gov.
- **Analyze an object's motion as it follows a trajectory.** To show that an object's speed is constant as it follows a trajectory (a curved path), take a video of the marble falling from the cup. Play it back on a TV or computer one frame at a time. Tape a transparency to the TV or computer screen, and make marks from frame to frame, measuring the horizontal distance traveled by the marble each time. Kids will see that the distance traveled in each frame is constant. Alternatively, have your kids try the Projectile Motion interactive at www.teachersdomain.org. Type "projectile motion" into the Teachers' Domain 'search' box.

CURRICULUM CONNECTIONS

On Target ties to the following concepts commonly covered in science, math, and technology curricula. For a list of education standards supported by the activity, see pages 41 and 42.

- **Newton's First Law**—As it travels down the zip line, the marble builds up a forward speed. Once launched, it will keep going at that speed until a force acts on it, such as hitting the ground.
- **Acceleration**—Due to Earth's gravitational pull, the marble's speed increases as it falls.
- **Vectors**—The marble's motion has both a horizontal and a vertical component, and these motions can be represented in a vector diagram.
- **Trajectory**—When an object that's already moving horizontally is dropped (like a marble dropped from a cup moving down a zip line), it travels in a curved path, called a trajectory.
- **Potential and kinetic energy**—The marble's stored (potential) energy changes to motion (kinetic) energy as it falls.
- **Measurement**—Kids measure to make the zip line. They also measure the height from which their marble is dropped and how far it lands from the target.

A NASA/DESIGN SQUAD CHALLENGE ON TARGET

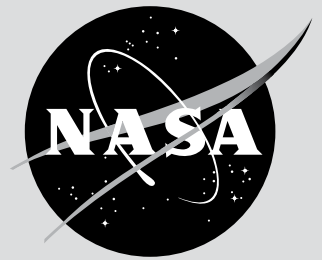

Thanks to NASA, the moon is getting a new crater! NASA is sending a spacecraft hurtling into the moon's surface. Why? To see if there's water below the surface. This collision will send up a plume of dust and gas over 6 miles (10 km) high. To tell if there's any water, scientists will look for ice crystals and water vapor in this plume.

WE CHALLENGE YOU TO...

...modify a paper cup so it can zip down a line and drop a marble onto a target.

BRAINSTORM AND DESIGN

Think about how you might design a way to carry and launch a marble:

- How will you modify the cup so it can carry a marble down a zip line and also drop it onto a target?
- How will you remotely release the marble from the cup?
- When do you need to launch the marble so that it will hit the target?

BUILD

1. **First, set up a zip line.** Tie 6 feet (1.8 m) of the smooth line to two objects (e.g., two chairs or a table and chair). Make sure it's stretched tight and that one end is about 20 inches (50 cm) below the other.
2. **Next, figure out how to modify the cup to carry the marble down the zip line.** Will it travel inside the cup? Outside the cup on a platform? Underneath?
3. **Then, add a remote release.** Decide how you will tip the cup at just the right instant to launch the marble toward the target.
4. **Finally, clip the cup to the zip line.** Figure out how to hook the cup onto the zip line so it slides easily.

TEST, EVALUATE, AND REDESIGN

Ready for a test run? Place the target near the end of the zip line. Send down the cup and try to hit the target with the marble, using the remote release. How close did you get? See a way to improve your design? Engineers improve their designs by testing them. The steps they follow are called the design process. Try your idea and build an improved version. For example, if your cup:

- **goes slowly**—Check that the zip line is steep enough. Also, make sure the cup slides freely.

MATERIALS (per zip line)

- 9 feet (3m) of smooth line (e.g., fishing line or kite string)
- index card
- marble
- masking tape
- paper clip
- 1 medium-sized paper cup
- scissors
- target drawn on a piece of paper

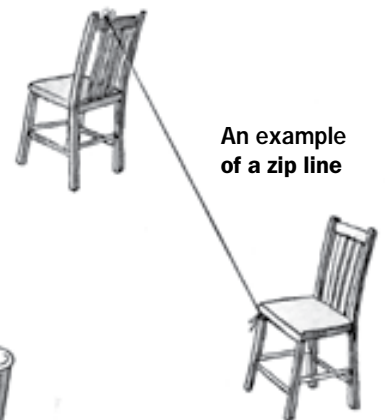

An example of a zip line



Materials to make a zip line, carrier, and target

- **can't keep the marble in**—Roll a small tube of tape to keep the marble from falling out accidentally. Also, adjust the tilt of the cup so it doesn't tip the marble out.
- **doesn't let the marble out**—Roll small tubes of tape and build a chute to funnel the marble toward the opening. If necessary, adjust the tilt of the cup so the marble can roll out more easily.
- **misses the target**—Since the marble is already moving forward along the zip line, it keeps moving forward as it falls. Make sure to take this forward motion into account as you choose a release point.

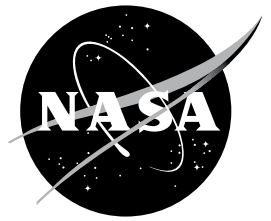

Check out NASA's moon missions at moon.msfc.nasa.gov.

"RUNNING AROUND IN THE WOODS HELPED ME THE MOST."



As a kid, Tony Colaprete loved nature, ecology, and running around in the woods. He liked thinking about how, in one way or another, everything is connected. He brings that kind of thinking to his job as a

planetary scientist and as the top scientist for NASA's LCROSS mission. To learn about how other planets work, he builds computer models and designs instruments. These help him understand the many interesting connections between the different planets in our solar system. And the more Tony discovers, the more we learn about how our world—Earth—fits within our solar system.

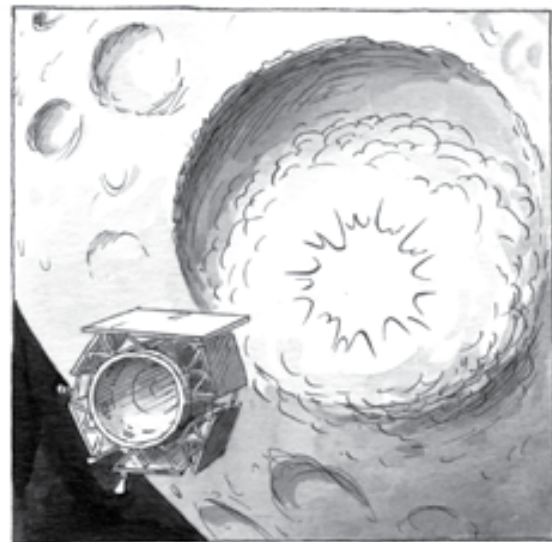

NASA's Lunar Crater Observation and Sensing Satellite (LCROSS) will hit the moon, raising a tall plume of dust and gas and hopefully revealing the presence of water.

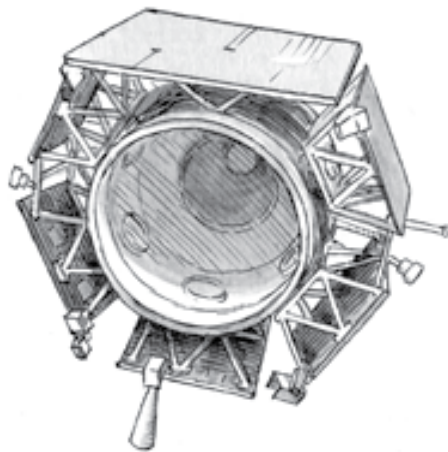

LOOK OUT BELOW!

NASA wants to make a deep hole on the moon to see if there's ice in the soil. But instead of beginning to dig at the surface, NASA is getting a head start. It will dig its hole at the bottom of a crater that's already about one mile (2 km) deep—and it won't dig, exactly. Instead, NASA will plunge a spacecraft named LCROSS into the crater. Scientists expect the collision will make a hole that's 80 ft. (24.4 m) across and 15 ft. (4.6 m) deep. The chances of finding ice at the bottom of this deep, dark, cold place are much better than finding it at the moon's surface, where the sun shines brightly on the soil, vaporizing any ice.

Watch DESIGN SQUAD on PBS or online at pbs.org/designsquad.



Major funding for *Design Squad* provided by



A private corporation funded by the American people



Education

Additional funding for *Design Squad* provided by



Design Squad is produced by WGBH Boston. *Design Squad*, AS BUILT ON TV, and associated logos are trademarks of WGBH. All rights reserved. This NASA/*Design Squad* challenge was produced through the support of the National Aeronautics and Space Administration (NASA).



For more information about NASA missions and educational programs, visit nasa.gov.

FEEL THE HEAT

LEADER NOTES

The Challenge

Design and build a solar hot water heater and see how big a temperature change you can get.

In this challenge, kids follow the engineering design process to: (1) build a solar hot water heater; (2) test to see if it can raise the temperature of water; and (3) use their testing results to improve their heater and get as big a temperature change as possible.

1 Prepare ahead of time

- Read the challenge sheet and leader notes to become familiar with the activity.
- Gather the materials listed on the challenge sheet.
- Build a sample hot water heater.
- The activity takes from 1½ to 2 hours.
Decide where to store kids' hot water heaters, if necessary.
- Decide whether you will use natural sunlight or a lamp to heat the hot water heaters.

2 Introduce the challenge (5 minutes)

- **Tell kids how NASA might use solar-powered heating on the moon.**

To survive long stays on the moon, astronauts will need buildings that can protect them from the moon's frigid temperatures—temperatures that are nearly twice as cold as Antarctica. One way to heat a building is to use the sun. Some places near the moon's poles get nearly constant sunshine. This steady supply of sunlight can be used to heat water. Once you have hot water, it can be pumped through a building to heat it.

- **Show kids your sample hot water heater.**

This is one kind of hot water heater. The water starts up here in the water-supply cup, flows down through the tube (thanks to gravity), gets warmed on the panel, and then flows out the end of the tube into a collection cup. This is just one way to make a hot water heater. You may want to make changes to this design to make it work better. Improving a design based on testing is called the engineering design process.

3 Brainstorm and design (10 minutes)

Distribute the challenge sheet. Discuss the questions in the Brainstorm and Design section.

SAFETY NOTE

If you use a lamp, keep the cord and bulb away from the water. To keep the lamp base far away from the hot water heater, use a gooseneck lamp. This kind of lamp also makes it easy for kids to keep the light bulb above the hot water heater.

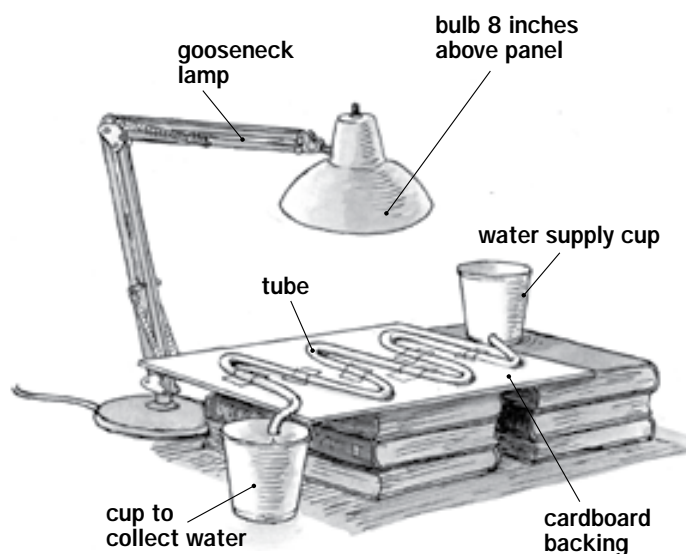

Sample solar hot water heater

- **What color should you make the tube and background?** (*Remind kids that the color black absorbs heat energy well and that white reflects it.*)
- **How fast should the water flow through the tube? How might its speed affect its temperature?** (*The more time water has to absorb heat energy, the warmer it will get. Kids can give water more time to absorb heat energy by slowing the flow.*)
- **How can zigzagging the tube help the water absorb heat from the sun or light bulb?** (*The longer light shines on the water in the tube, the warmer the water will get. If kids run the tube so most of it lies where the light is strong, the water will absorb more heat.*)

HOW TO MEASURE THE CHANGE IN WATER TEMPERATURE

Review how to use a digital indoor-outdoor thermometer to measure the before and after temperature of the water. The sensor at the end of the long wire is the “outdoor” part of the thermometer. Dip it into the pitcher of cold water. Wait one minute or until the “outdoor” display stops changing. Record this “before” temperature. Turn on the lamp and position it eight inches above the hot water heater. Fill the supply cup with water from the pitcher. As it trickles out the end of the tube into the collection cup, hold the tip or the wire in the stream of water. Tell kids not to touch the tip—heat from their hands will affect the reading. Record this “after” temperature. By comparing it to the “before” temperature, kids can calculate the increase in water temperature.

4 Build, test, evaluate, and redesign (60 minutes)

Help kids with any of the following issues. For example, if:

- **water leaks**—*Add more tape to the junctions or redo them.*
- **kids forget how to measure temperature change**—*Kids should record the temperature of the water in the pitcher. They then should pour water from the pitcher into the supply cup at the top of the heater and measure the temperature just as it flows out of the tube.*
- **there is little temperature change**—*This means the water needs to spend more time in the light. Have kids put more of the tube where the light is the strongest, make the tube longer, or slow down the water flow. Also, suggest that they color the tubes black or put a piece of black paper behind the tube to absorb more heat energy.*
- **the tube isn't long enough**—*Make the tube longer by attaching two or three together.*
- **water runs through the tube too quickly**—*Change how fast the water flows. Pinch the tube with tape or paper clips. Also, check the height of the water supply cup. The higher it is above the end of the tube, the faster the water will flow. To slow the flow, move them so the two cups are nearly at the same height.*

5 Discuss what happened (10 minutes)

Have the kids show each other their heaters and talk about how they solved any problems that came up. Emphasize the key ideas in today's challenge by asking:

- **How might astronauts use a solar water heater?** (*Solar hot water heaters can heat water for daily use. The hot water can also be used to heat lunar outposts, greenhouses, and other structures.*)
- **Where did conduction, convection, and radiation occur in your water heater?** (*Conduction occurred where the tube was in direct contact with the warm panel and heated air molecules. Convection occurred when the warm solar panel [and light, if one was used] heated the air, making it less dense and causing it to rise. Radiation occurred when heat was transferred from the heat source via infrared radiation and light.*)

- **Which features help a solar hot water heater use solar energy (light and infrared radiation) to heat water?** (Key features include: large surface area angled to face the light, black color, thin tubing for efficient heat absorption, transparent cover to minimize heat loss, and insulation.)
- **Engineers' early ideas rarely work out perfectly. How does testing help them improve a design?** (Testing helps you see what works and what doesn't. Knowing this lets you improve a design by fixing the things that aren't working well or could work even better.)
- **How do the stories on the back of the handout about exploring the moon relate to today's activity?** (Kids learn how cold it is on the moon and how NASA uses sunlight to generate electricity.)

EXTEND THE CHALLENGE

- **Concentrate the light to get the water hotter.** Have kids use file folders and aluminum foil to make panels that can reflect and concentrate light. Have kids attach their reflectors to their hot water heaters. Calculate the average temperature change of the group's hot water heaters.
- **Connect hot water heaters in a series.** After kids succeed with their individual hot water heaters, connect several together. Does letting the water run through several solar hot water heaters heat the water a lot more than when it runs through just one?
- **Make a solar cooker!** Have your kids use the engineering design process to make a solar cooker and cook marshmallows for hungry astronauts. Find this activity at: pbs.org/wgbh/nova/teachers/activities/3406_solar.html.
- **Watch a PBS show about solar energy.** View the PBS NOVA program *Saved by the Sun*. It outlines innovative ways that solar energy is being used to provide heat energy and power. It is streamed online at: pbs.org/wgbh/nova/solar/.

CURRICULUM CONNECTIONS

Feel the Heat ties to the following concepts commonly covered in science, math, and technology curricula. For a list of education standards supported by the activity, see pages 42 and 43.

- **Heat transfer**—Heat is transferred from the sun/lamp to the tube by radiation (i.e., infrared waves—see below). The tube transfers its heat to the water by direct contact (i.e., conduction).
- **Infrared radiation**—It is the infrared part of the electromagnetic spectrum coming from the light/sun that changes the water temperature.
- **Converting light to heat energy**—Some shapes, colors, and materials are particularly good at absorbing light energy and releasing it as heat energy.
- **Gravity-fed water systems**—Gravity pulls the water through the solar panel's tube when the supply cup is placed higher than the collection cup.
- **Measurement**—Kids measure the volume of water, the temperature change, and the rate of water flow.

FEEL THE HEAT

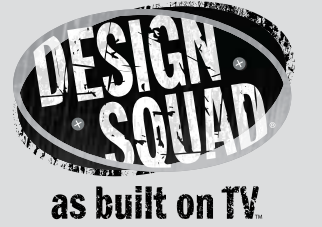
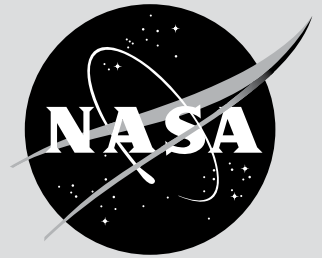

Colder than Antarctica? Welcome to the moon! To survive on the moon, astronauts will need buildings that can protect them from temperatures as low as -250° Fahrenheit (-157° Celsius). One way to heat these buildings is to use sunlight to heat water and pump it through the rooms.

WE CHALLENGE YOU TO...

...design and build a solar hot water heater and see how big a temperature change you can get.

BRAINSTORM AND DESIGN

To heat water with your heater:

- What color should you make the tube and background?
- Being exposed to light is what heats water. How fast do you want water to flow through the tube?
- How can the way you zigzag the tube across the cardboard help the water in the tube absorb heat from the sun or light bulb?

BUILD

- 1. First, get water to flow through the tube.** Poke a small hole near the bottom of a cup. Put the tube into the hole. Set a second cup under the tube's other end. Test your system with water. Seal any leaks.
- 2. Then, build your hot water heater.** Use the materials to design a system that can help the water absorb a lot of heat energy.

TEST, EVALUATE, AND REDESIGN

- Put your heater in strong sunlight or 8 inches (20 cm) below the lamp. (SAFETY NOTE: Keep water away from the outlet, lamp, and bulb.)
- Measure and record the temperature of the water in the pitcher.
- Pour water from the pitcher into the supply cup.
- Record the temperature of the water as it comes out of the lower end of the tube.

Starting temperature: _____

Ending temperature: _____

Temperature change: _____

MATERIALS (per heater)

- aluminum foil
- large sheet of cardboard (e.g., 11 x 17 inches / 28 x 43 cm)
- gooseneck lamp with an indoor 100-watt floodlight light bulb (optional if using sunlight)
- black marker
- black paper
- 2 paper cups (medium-sized)
- 3 feet (0.9 m) clear plastic tubing (Outside diameter: $\frac{1}{4}$ inch / 6 mm)
- pitcher of water
- ruler
- scissors
- straws
- duct tape
- an indoor-outdoor digital thermometer that can read tenths of a degree

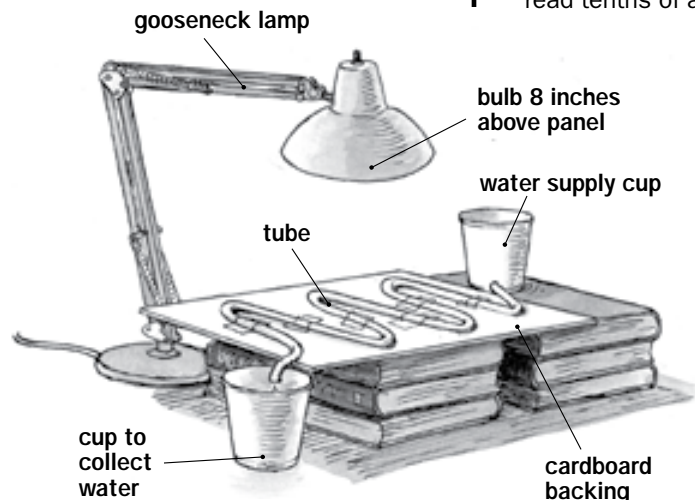

TEST, EVALUATE, AND REDESIGN (CONTINUED)

Can you get an even bigger change? Engineers test a design and improve it based on what they learn. This is called the design process. See how big a change you get.

- **Help the water absorb more heat**—Add materials above, below, or around the tube to focus more heat energy on the water. Also think how you can use color to help heat the water.
- **Slow the flow**—The longer the water stays in the light, the more it will heat up. Figure out how to make the water flow slowly through the tube.
- **Make your tube longer**—A longer tube can help water stay in the light for a longer time. Tape two tubes together.
- **Air bubbles clog the tube**—Blow into the tube to clear it.

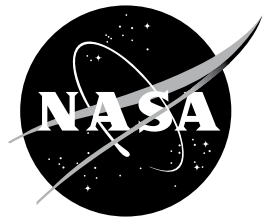

Check out NASA's moon missions at moon.msfc.nasa.gov.

WHAT SHALL I WEAR?

Ever have trouble deciding what to wear? Try packing for the moon! On the moon, daily temperatures can swing about 500° Fahrenheit (260° Celsius). It can get up to 250° F (121° C) during the day, and at night, it can drop to -250° F (-157° C). Earth's blanket of

air—the atmosphere—keeps us at a comfortable average temperature of 60° F (16° C).

But the moon has no atmosphere to hold heat.

Better bring a well-insulated space suit when you visit!

Buzz Aldrin wore a million dollar spacesuit (left) designed to protect him from the moon's extreme hot and cold temperatures.

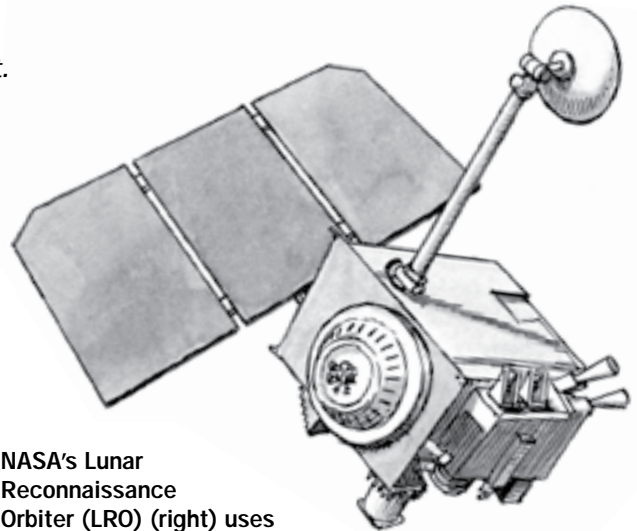

NASA's Lunar Reconnaissance Orbiter (LRO) (right) uses a large solar panel to turn sunlight into electricity.

RUN BY THE SUN

Make your own electricity? In space, NASA's LRO spacecraft uses large solar panels to turn sunlight into electricity. They can produce about 1850 watts—enough to run a large microwave oven. But on average, LRO only uses 800 watts—enough to run a small toaster. The extra electricity is stored in batteries on board the LRO. When LRO goes into the shadow behind the moon, the darkness there prevents it from using the energy from the solar panels. So it powers itself with the batteries.

Watch DESIGN SQUAD on PBS or online at pbs.org/designsquad.



Major funding for *Design Squad* provided by



Corporation for Public Broadcasting

A private corporation funded by the American people



Education

Additional funding for *Design Squad* provided by



National Council of Examiners for Engineering and Surveying



NOYCE FOUNDATION

NORTHROP GRUMMAN Foundation



Design Squad is produced by WGBH Boston. *Design Squad*, AS BUILT ON TV, and associated logos are trademarks of WGBH. All rights reserved. This NASA/*Design Squad* challenge was produced through the support of the National Aeronautics and Space Administration (NASA).



For more information about NASA missions and educational programs, visit nasa.gov.

EDUCATION STANDARDS

LAUNCH IT

National Science Education Standards (Grades 3–8)

Physical Science

- Properties of Objects and Materials (K–4)
- Position and Motion of Objects (K–4)
- Motion and Forces (5–8)

Science and Technology

- Abilities of Technological Design (3–8)
- Understandings About Science and Technology (3–8)

International Technology Education Association Content Standards (Grades 3–8)

Design

- Standard 2: Students will develop an understanding of the core concepts of technology.
- Standard 8: Students will develop an understanding of the attributes of design.
- Standard 9: Students will develop an understanding of engineering design.
- Standard 10: Students will develop an understanding of the role of troubleshooting, research and development, invention and innovation, and experimentation in problem solving.

Abilities for a Technological World

- Standard 11: Students will develop abilities to apply the design process.
- Standard 12: Students will develop abilities to use and maintain technological products and systems.

Massachusetts Science and Technology/Engineering Standards (Grades 3–8)

Physics (3–5)

- Observable Properties of Objects
- Position and Motion of Objects
- Forms of Energy
- Conservation of Energy

Physics (6–8)

- Conservation of Energy
- Forms of Energy

Technology/Engineering (3–8)

- Materials, Tools, and Machines
- Engineering Design

National Council of Teachers of Mathematics Standards (Grades 3–8)

Problem Solving

- Build new mathematical knowledge through problem solving
- Solve problems that arise in mathematics and in other contexts
- Apply and adapt a variety of appropriate strategies to solve problems

Measurement

- Understand measurable attributes of objects and units, systems, and processes of measurement
- Apply appropriate techniques, tools, and formulas to determine measurements

TOUCHDOWN

National Science Education Standards (Grades 3–8)

Physical Science

- Properties of Objects and Materials (K–4)
- Position and Motion of Objects (K–4)
- Motion and Forces (5–8)

Science and Technology

- Abilities of Technological Design (3–8)
- Understandings About Science and Technology (3–8)

International Technology Education Association Content Standards (Grades 3–8)

Design

- Standard 2: Students will develop an understanding of the core concepts of technology.
- Standard 8: Students will develop an understanding of the attributes of design.
- Standard 9: Students will develop an understanding of engineering design.
- Standard 10: Students will develop an understanding of the role of troubleshooting, research and development, invention and innovation, and experimentation in problem solving.

Abilities for a Technological World

- Standard 11: Students will develop abilities to apply the design process.
- Standard 12: Students will develop abilities to use and maintain technological products and systems.

The Designed World

- Standard 16: Students will develop an understanding of and be able to select and use energy and power technologies.

Massachusetts Science and Technology/Engineering Standards (Grades 3–8)

Physics (3–8)

- Observable Properties of Objects
- Position and Motion of Objects
- Properties of Objects and Materials
- Forms of Energy

Technology/Engineering (3–8)

- Materials and Tools
- Engineering Design

National Council of Teachers of Mathematics Standards (Grades 3–8)

Problem Solving

- Build new mathematical knowledge through problem solving
- Solve problems that arise in mathematics and in other contexts
- Apply and adapt a variety of appropriate strategies to solve problems

Measurement

- Understand measurable attributes of objects and units, systems, and processes of measurement
- Apply appropriate techniques, tools, and formulas to determine measurements

ROVING ON THE MOON

National Science Education Standards (Grades 6–12)

Physical Science

- Motions and Forces (6–12)
- Transfer of Energy (5–8)
- Conservation of Energy (9–12)

Science and Technology

- Abilities of Technological Design (6–12)
- Understandings About Science and Technology (6–12)

International Technology Education Association Content Standards (Grades 6–12)

Design

- Standard 8: Students will develop an understanding of the attributes of design.
- Standard 9: Students will develop an understanding of engineering design.
- Standard 10: Students will develop an understanding of the role of troubleshooting, research and development, invention and innovation, and experimentation in problem solving.

Abilities for a Technological World

- Standard 11: Students will develop abilities to apply the design process.
- Standard 12: Students will develop abilities to use and maintain technological products and systems.
- Standard 13: Students will develop abilities to assess the impact of products and systems.

The Designed World

- Standard 16: Students will develop an understanding of and be able to select and use energy and power technologies.

Massachusetts Science and Technology/Engineering Standards (Grades 6–12)

Physics (6–8)

- Position and Motions of Objects
- Forms of Energy

Physics (9–12)

- Motion and Forces
- Conservation of Energy and Momentum

Technology/Engineering (6–12)

- Materials, Tools, and Machines
- Engineering Design
- Steps in the Design Process

National Council of Teachers of Mathematics Standards (Grades 6–12)

Problem Solving

- Build new mathematical knowledge through problem solving
- Solve problems that arise in mathematics and in other contexts
- Apply and adapt a variety of appropriate strategies to solve problems

Measurement

- Understand measurable attributes of objects and units, systems, and processes of measurement
- Apply appropriate techniques, tools, and formulas to determine measurements

HEAVY LIFTING

National Science Education Standards (Grades 6–12)

Physical Science

- Motions and Forces (6–12)
- Transfer of Energy (6–8)
- Conservation of Energy (9–12)

Science and Technology (6–12)

- Abilities of Technological Design
- Understandings About Science and Technology

International Technology Education Association Content Standards (Grades 6–12)

Design

- Standard 8: Students will develop an understanding of the attributes of design.
- Standard 9: Students will develop an understanding of engineering design.
- Standard 10: Students will develop an understanding of the role of troubleshooting, research and development, invention and innovation, and experimentation in problem solving.

Abilities for a Technological World

- Standard 11: Students will develop abilities to apply the design process.
- Standard 12: Students will develop abilities to use and maintain technological products and systems.
- Standard 13: Students will develop abilities to assess the impact of products and systems.

The Designed World

- Standard 16: Students will develop an understanding of and be able to select and use energy and power technologies.

Massachusetts Science and Technology/Engineering Standards (Grades 6–12)

Physics (6–8)

- Position and Motions of Objects
- Forms of Energy

Physics (9–12)

- Motion and Forces
- Conservation of Energy and Momentum

Technology/Engineering (6–12)

- Materials, Tools, and Machines
- Engineering Design
- Steps in the Design Process
- Construction

National Council of Teachers of Mathematics Standards (Grades 6–12)

Problem Solving

- Build new mathematical knowledge through problem solving
- Solve problems that arise in mathematics and in other contexts
- Apply and adapt a variety of appropriate strategies to solve problems

Measurement

- Understand measurable attributes of objects and units, systems, and processes of measurement
- Apply appropriate techniques, tools, and formulas to determine measurements

ON TARGET

National Science Education Standards (Grades 6–12)

Physical Science

- Transfer of Energy (6–8)
- Motions and Forces (6–12)
- Conservation of Energy (9–12)

Science and Technology (6–12)

- Abilities of Technological Design
- Understandings About Science and Technology

International Technology Education Association Content Standards (Grades 6–12)

Design

- Standard 8: Students will develop an understanding of the attributes of design.
- Standard 9: Students will develop an understanding of engineering design.
- Standard 10: Students will develop an understanding of the role of troubleshooting, research and development, invention and innovation, and experimentation in problem solving.

Abilities for a Technological World

- Standard 11: Students will develop abilities to apply the design process.
- Standard 12: Students will develop abilities to use and maintain technological products and systems.
- Standard 13: Students will develop abilities to assess the impact of products and systems.

The Designed World

- Standard 16: Students will develop an understanding of and be able to select and use energy and power technologies.

Massachusetts Science and Technology/Engineering Standards (Grades 6–12)

Physics (6–8)

- Position and Motions of Objects
- Forms of Energy

Physics (9–12)

- Motion and Forces
- Conservation of Energy and Momentum

Technology/Engineering (6–12)

- Materials, Tools, and Machines
- Engineering Design
- Steps in the Design Process

National Council of Teachers of Mathematics Standards (Grades 6–12)

Problem Solving

- Build new mathematical knowledge through problem solving
- Solve problems that arise in mathematics and in other contexts
- Apply and adapt a variety of appropriate strategies to solve problems

Algebra

- Represent and analyze mathematical situations and structures using algebraic symbols

Measurement

- Understand measurable attributes of objects and units, systems, and processes of measurement
- Apply appropriate techniques, tools, and formulas to determine measurements

FEEL THE HEAT

National Science Education Standards (Grades 9–12)

Physical Science

- Conservation of Energy
- Interactions of Energy and Matter

Science and Technology

- Abilities of Technological Design
- Understandings About Science and Technology

International Technology Education Association Content Standards (Grades 9–12)

Design

- Standard 8: Students will develop an understanding of the attributes of design.
- Standard 9: Students will develop an understanding of engineering design.
- Standard 10: Students will develop an understanding of the role of troubleshooting, research and development, invention and innovation, and experimentation in problem solving.

Abilities for a Technological World

- Standard 11: Students will develop abilities to apply the design process.
- Standard 12: Students will develop abilities to use and maintain technological products and systems.
- Standard 13: Students will develop abilities to assess the impact of products and systems.

The Designed World

- Standard 16: Students will develop an understanding of and be able to select and use energy and power technologies.

Massachusetts Science and Technology/Engineering Standards (Grades 9–12)

Physics

- Heat and Heat Transfer
- States of Matter
- Forms of Energy

Technology/Engineering

- Materials, Tools, and Machines
- Engineering Design
- Thermal Systems

National Council of Teachers of Mathematics Standards (Grades 9–12)

Problem Solving

- Build new mathematical knowledge through problem solving
- Solve problems that arise in mathematics and in other contexts
- Apply and adapt a variety of appropriate strategies to solve problems

Measurement

- Understand measurable attributes of objects and units, systems, and processes of measurement
- Apply appropriate techniques, tools, and formulas to determine measurements

On the Moon

EDUCATOR REPLY CARD

To achieve America's goals in Educational Excellence, it is NASA's mission to develop supplementary instructional materials and curricula in science, mathematics, geography, and technology. NASA seeks to involve the educational community in the development and improvement of these materials. Your evaluation and suggestions are vital to continually improving NASA educational materials.

Please take a moment to respond to the statements and questions below. You can submit your response by mail.

1. With what grades did you use the educator guide?

Number of Teachers/Faculty:

K-4 5-8 9-12 Community College

College/University - Undergraduate Graduate

Number of Students:

K-4 5-8 9-12 Community College

College/University - Undergraduate Graduate

Number of Others:

Administrators/Staff Parents Professional Groups

General Public Civic Groups Other

2. What is your home 5- or 9-digit zip code? _____

3. This is a valuable educator guide?

Strongly Agree Agree Neutral Disagree Strongly Disagree

4. I expect to apply what I learned in this educator guide.

Strongly Agree Agree Neutral Disagree Strongly Disagree

Fold along line and tape closed.

5. What kind of recommendation would you make to someone who asks about this educator guide?

Excellent Good Average Poor Very Poor

6. How did you use this educator guide?

Background Information Critical Thinking Tasks
 Demonstrate NASA Materials Demonstration
 Group Discussions Hands-On Activities
 Integration Into Existing Curricula Interdisciplinary Activity
 Lecture Science and Mathematics
 Team Activities Standards Integration
 Other: Please specify: _____

7. Where did you learn about this educator guide?

NASA Educator Resource Center
 NASA Central Operation of Resources for Educators (CORE)
 Institution/School System
 Fellow Educator
 Workshop/Conference
 Other: Please specify: _____

8. What features of this educator guide did you find particularly helpful?

9. How can we make this educator guide more effective for you?

10. Additional comments:

Today's Date: _____

Fold along line and tape closed.



MARSHALL SPACE FLIGHT CENTER
ACADEMIC AFFAIRS OFFICE
HS30
C/O INFORMAL EDUCATION
HUNTSVILLE, AL 35812



Please Place
Stamp Here
Post Office
Will Not Deliver
Without Proper
Postage



CREDITS

On the Moon was produced by the WGBH Educational Outreach department, in collaboration with NASA.

Director, Educational Outreach

Julie Benyo

Associate Director, Educational Outreach

Thea Sahr

Educational Content Manager

Sonja Latimore

Editorial Project Director

Chris Randall

Associate Editor

Joan Pedersen

Outreach Coordinator

Natalie Hebshie

Outreach Assistant

Margot Sigur

Writer

Jeff Lockwood

Evaluator

Christine Andrews Paulsen, Ph.D.
American Institutes for Research

Advisors

Jenny Atkinson, M.Ed.
*Executive Director, Charlestown Club,
Boys & Girls Club of Boston*

Brian Day
*Education and Public Outreach Lead
Lunar Crater Observation and
Sensing Satellite
NASA Ames Research Center*

Michelle Hailey
*Manager, THE ARTS
Girl Scouts of the USA*

Jerry G. Hartman
*Education Lead—Exploration
Systems Mission Directorate
NASA Headquarters*

Al Krause
*Education Specialist—WILL
Technology, Inc.
Academic Affairs Office
NASA Marshall Space Flight Center*

Hollington Lee
Curriculum consultant

Rick McMaster, Ph.D., P.E.
*Executive Project Manager, IBM
Chair, Central Texas Discover
Engineering*

Dawn Mercer
*Education Specialist—WILL
Technology, Inc.
NASA Marshall Space Flight Center*

Brian Mitchell
*Education and Public Outreach
Program Manager
Lunar Precursor Robotic Program
NASA Marshall Space Flight Center*

Danielle Moran
*Communications Strategist
Lunar Precursor Robotic Program
NASA Marshall Space Flight Center*

Kate L. Pickle
*STEM Program Manager
Girl Scouts of the USA*

Stephanie Stockman
*Education and Public Outreach Lead
Lunar Reconnaissance Orbiter
NASA Goddard Space Flight Center*

Senior Designer

Peter Lyons

Designers

Greta Merrick
Jonathan Rissmeyer

Illustrator

Hannah Bonner

Senior Executive Producer

Kate Taylor

Series Executive Producer

Marisa Wolsky

Series Content Director

Dr. David Wallace
*Associate Professor of Mechanical
Engineering
Massachusetts Institute of
Technology*

Field Test Sites

Donna Falk
*Manalapan-Englishtown Middle
School
Manalapan, NJ*

Matthew Loughran
*Watertown Middle School
Watertown, MA*

Von Mom, and
Michelle Hatem Meehan
*Lowell Boys and Girls Club
Lowell, MA*

NOTES



