

Early Child Development Kit: A Treasure Box of Activities

Activity Guide

UNICEF
ECD Unit
July 2009
Working Draft

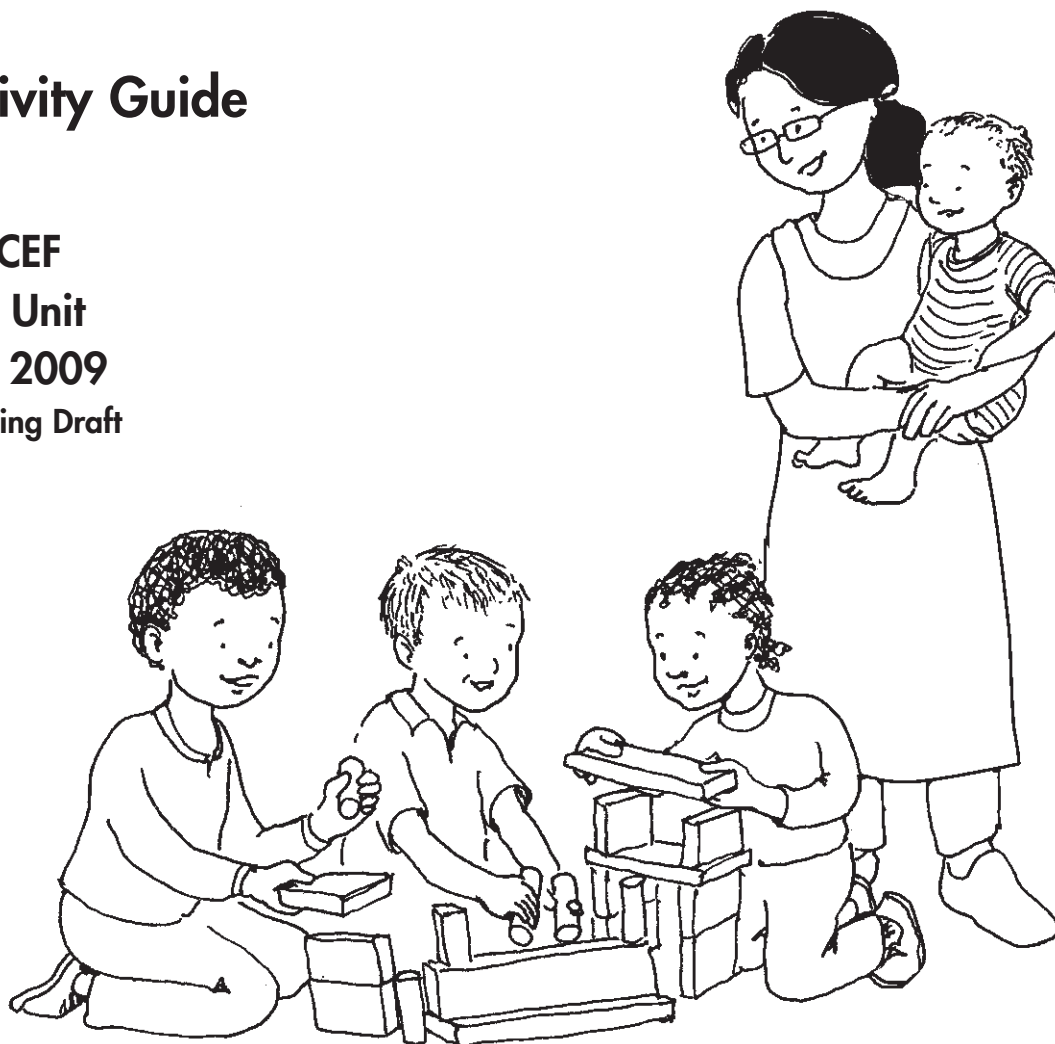

Acknowledgments

This prototype document* was prepared by the ECD Unit with the help of Cassie Landers.

Disclaimer

Opinions and statements within this document are entirely those of the author and should not be attributed in any manner to the United Nations Children's Fund (UNICEF), its affiliated organizations, or the members of its Executive Directors or the countries they represent.

The text has not been edited to official publication standards and UNICEF accepts no responsibility for errors.

The designations in this publication do not imply an opinion on the legal status of any country or territory, or of its authorities, or the delimitation of borders.

Illustration

The document was illustrated by Joan Auclair.

**This prototype will be finalized and published after extensive consultation with the field implementers and feedback received from our different partners.*

For more information, please contact:
Early Childhood Development / PDO
UNICEF House
3 UN Plaza
New York, NY 10017
USA
E-mail: aconchon@unicef.org
Tel: +1 212 824 6554

Early Child Development Kit: A Treasure Box of Activities

Activity Guide

Welcome!

How much are young children affected by events that take place around them?

A lot. Young children are active players in the world. Even though they may not understand the meaning of what they see or hear, children absorb the images that surround them and are deeply impacted by the emotions of the people they rely on for love and security.

Parents and caregivers play a very important role in helping young children cope with and recover from traumatic and stressful experiences. Providing young children with sensitive and responsive care takes a lot of emotional and physical energy. But the everyday moments shared between a child and caring adults can be mutually healing. During difficult and uncertain times, simply finding comfort in each other's presence is the first step to helping young children cope and heal.



The Power of Play

Children are curious from the moment they are born. They want to learn about and understand their world. During the first five years of life children's brains are growing faster than at any other time of life. Children's early experiences shape how their brains develop. Children's early learning sets the stage for school success.

Good early experiences help a child's brain develop well. The more work the brain does, the more it is capable of doing. When children play, their brains work hard.

Playing is how children learn. Play comes naturally to children. They play during daily routines. They play during learning experiences you provide. Think about a baby who starts a peek-a-boo game with you when you pull her shirt over her head. The toddler or two-year-old who imitates the way you read to her as she reads to her doll. Or the three-or-four year old who scribbles and marks on a large sheet of paper you put out on the table, then announces proudly, "I wrote my name."

Sometimes it may look like not much is happening. Filling and dumping small objects from a can may seem boring to you. Playing blocks seems like just stacking them and knocking them down.

But play is filled with opportunities for children to learn and develop new skills. When children play, they use all their senses – hearing, seeing, tasting, touching, smelling and moving – to gather information about their world. Later they will gather information through language. They organize and reorganize this information into their first pictures of themselves, others, and their world.

Through the fun games in this Treasure Box, children – both older and younger – will develop new skills for talking and thinking, moving and doing, feeling and learning about themselves, and getting along with others.

Learning through Play

Look at how much children are learning as they play together with blocks:

Talking and Thinking

They may learn to:

Connect words to actions as they talk together about what they are doing.

Participate in conversations about what they are doing.

Understand position words as they walk *on* a path of blocks *next to* the table.

Understand concepts such as soft, hard, big, small, heavy, light, rough and smooth.

Use their imagination as they tell a story about what they have created.

Make a plan as they decide what to build together.

Complete a task as they make a path of blocks.

Moving and Doing

They may learn to:

Develop awareness of where they are going as they walk on a path of blocks.

Develop balance when moving as they carry blocks across the room.

Use hand and wrist muscles to do delicate tasks as they make a stack of small blocks.



Feelings and learning about self:

They may learn to:

Express their feelings when they discover: “I like to build.”

Feel “I can do it!” as they complete a tower of blocks – or knock a block tower over.

Getting Along with others

They may learn to:

Play with other children.

Cooperate with others as one child hands another a block.

Follow a simple rule that keeps everyone safe, such as “no throwing blocks.”

Why an ECD Kit?

Giving time for and helping children play during times of stress is one of the most important things you can do. This ECD Kit of activities was created to help you help young children continue to develop their skills for thinking, speaking, and interacting with people and things even when times are very difficult. We hope these fun learning activities will help to stimulate children’s eager minds, quiet their hearts, and give them hope. When you help young children feel safe and secure they can be free to learn now and in the future.

What is inside the ECD Kit?

This ECD Treasure Box is filled with materials and ideas for learning and fun. Each item was carefully chosen to support the important work you do each day. Each one can be used in different ways depending on the age and interest of the child. Here is a list of the children’s treasures you will find.

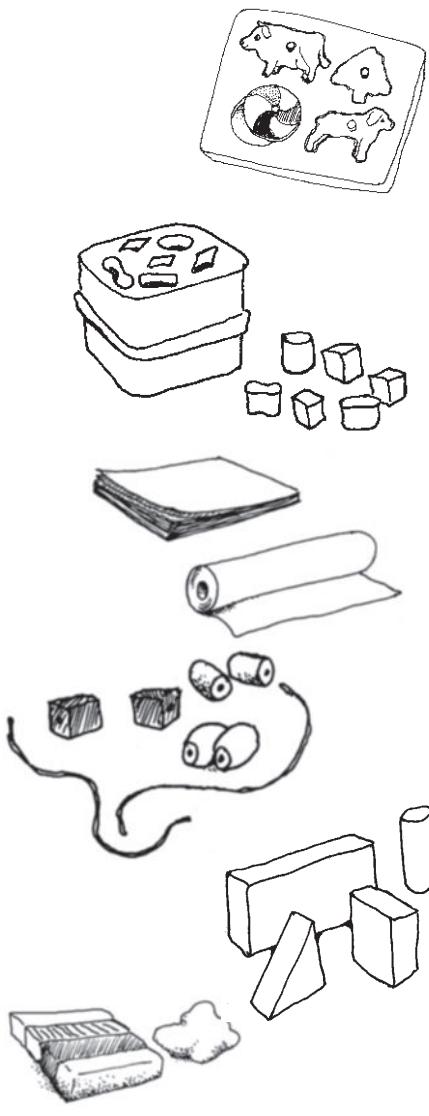

Games and Activities			
	Babies	1–3 Years	4–6 Years
1. Board Puzzle	*	*	
2. Chain Puzzle	*	*	
3. Board Book	*	*	*
4. Sponge Balls	*	*	*
5. Shape Sorter	*	*	*
6. Paper and Crayons	*	*	*
7. Stringing Beads	*	*	*
8. Puppets	*	*	*
9. Stack and Sort Kit	*	*	*
10. Dominoes	*	*	*
11. Construction Blocks	*	*	*
12. Modeling Clay		*	*
13. Puzzle Blocks		*	*
14. Memory Game		*	*
15. Counting Circle			*
16. Jigsaw Puzzle			*

Treasures for Caregivers

The ECD kit also contains materials to help you create a safe learning space for young children. Look for tape, pen, pencils, paper, exercise book markers, and flipcharts. A water container and soap will help you to keep the materials and children clean.

Activity Cards

These activity cards have been developed to help you use the materials in the ECD kit. There is one activity sheet for each item. The activities are arranged from easier to harder. Each item can be used in different ways for babies, for children from one to three years; and children from four to six years.

These symbols will help you find the right activity for the right age.

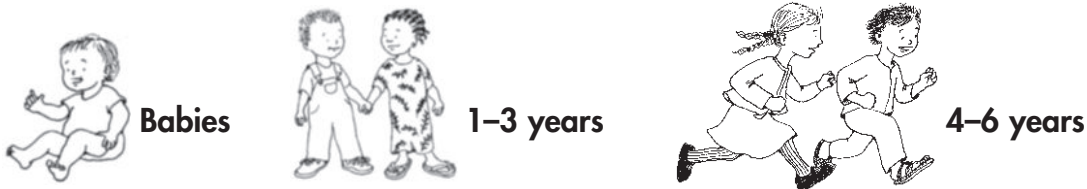

Each activity sheet also includes:



What you can do

Ideas for how to use the material to help children's develop skills for talking and thinking, moving and doing, learning about self and getting along with others.



What to look for

Things to observe in children as they play



Possible extensions

Suggestions for other things you might do



Caution

Tips to help you keep children safe while playing

Children are learning from you and each other all the time. There are many ways you can help children develop without any materials. For example, children love listening to your stories and telling you theirs; making up silly rhymes; and talking about their feelings. Look for the activity sheets that give you some more ideas on what to do even without any materials.

This is just a beginning. We know you have many ideas of materials and fun games to add. Use these materials with children. Adapt them. Get ideas for new toys and games to make and play.

Sometimes it can be tempting to put new materials away from children to keep them safe and clean. Please don't. These materials are made for children to touch, shake, stack, toss, pretend with, jump in and out of, put together, take apart. The only way children can benefit from the treasures in this box – and others you add – is if they have the chance to play with them.

How can you use the ECD Kit?

Gather children around the treasures in the ECD Kit in a safe and welcoming space. As many as 50 children can participate at any one time. That's a lot of children. Try creating small groups and assign different activities. Sometimes, a child might need a little extra attention and some special time just with you. Make sure you have help. Invite older children, parents, and other adults to help you plan and organize the activities.

Here are some helpful tips to think about.

- *Create small groups of children.* You might try grouping children by age—babies, one to three year olds, and four to six year olds. Other activities work best when all the children are learning together. The activity cards will help you plan your program.
- *Invite older children and siblings to help you.* Encourage them to organize and plan activities. They can also be paired with a child who needs extra care and attention. This is a wonderful way for both older and younger children to learn together.
- *Provide opportunities for parents to support their child's play, learn from each other and from you.* Invite groups of parents to join you in the fun. The possibilities are endless. Think together about some activities children can do and what children may learn. As you work, encourage families to share their stories and questions with each other and you.
- *Make safety a priority.* Make sure the space is safe from things that might hurt small children. Keep all materials clean. Store them carefully.
- *Routines are important.* Children need lots of consistent attention especially during times of stress. Try to organize your activities at the same time each day. Children feel safe knowing they will spend some time each day with you and the treasure box.



- *Be creative.* The materials in the kit will help you get started. Make up your own games and activities. Sing familiar songs, tell stories, play traditional games, dance and sing.
- *Listen.* Your care and attention is the most important gift you can give to young children. Help them find words to express their feelings. Encourage drawing, telling stories, and pretend play.
- *Preparation and planning.* A little planning helps to make your time with children more meaningful. Try creating a simple schedule. Here is an example.

Treasure Box Fun: Daily Activity Plan

- 10:00 Welcome children and families
- 10:15 Circle Time: Select a fun topic. Ask children to talk about what they know
- 10:45 Small groups: Divide children into age groups. Let children explore and play with activities on their own.
- 10:30 Pairs: Older children spend time working with smaller children on a specific activity
- 11:30 Circle Time: Story telling. Try letting children make up a new ending!
- 12:00 Closing Song

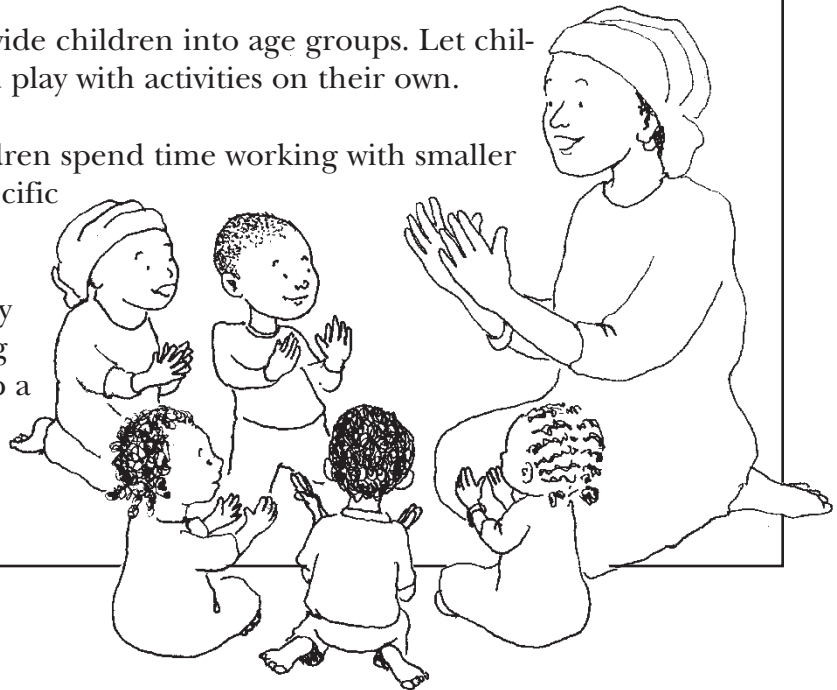

The materials in this box become true treasures in your hands as you share them with children and families. Thank you for your time, energy, and commitment to helping young children grow, develop, and heal.

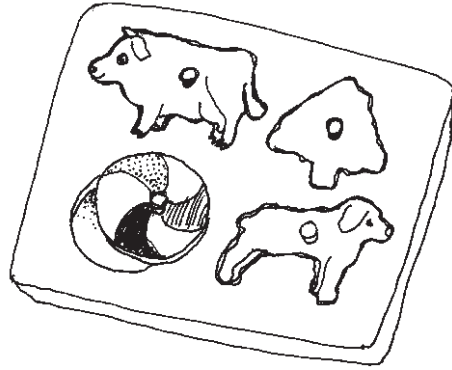

Board Puzzle

1

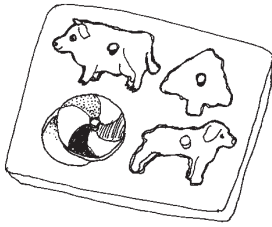

Board Puzzle

Babies



What You Can Do

- Taking the puzzle pieces out will be the first skill that infant will master quite easily. Banging the puzzle pieces together or on the floor is also a lot of fun because it makes a lot of noise, which infants love.
- Let the infant explore how to identify and scan the puzzle piece and the outline of the hole where it belongs.
- Observe how the infant matches the picture of the puzzle piece and the hole where it belongs.
- Encourage children by talking and referring to the colors and shapes of the puzzle.



What To Look For

- Infants are learning to use their eyes to help them reach and grab for objects, so puzzle pieces with different shapes, textures, and size are particularly good for improving this ability.



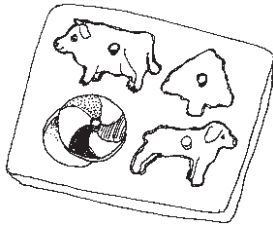

Board Puzzle

1–3 years



What You Can Do

- Caregiver explains that puzzle pieces come in different shapes and sizes. Some pieces have bumps with rounded corners.
- Ask a child or a group of children to complete the puzzle; ask them to memorize where each piece fits.
- Form a group of children and challenge them to complete the puzzle as fast as they can. Everyone should participate in completing the puzzle.



What To Look For

- Children concentrate and are quiet, but their minds are expanding. Puzzles provide children with opportunities to think and reason.



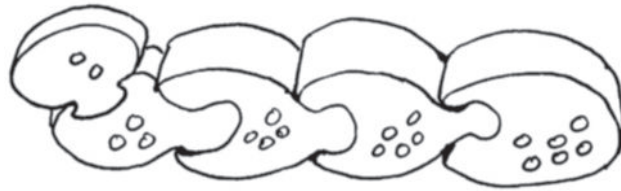

Chain Puzzle

2

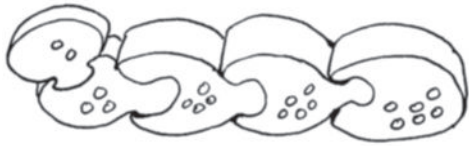

Chain Puzzle

Babies



What You Can Do

- Place the individual pieces in front of the baby. Let her reach for and hold the puzzle pieces. Can she hold one in each hand? Clap them together. Listen to the sound.
- Talk to the baby about the different colors in the puzzle.
- Hide one of the puzzle pieces under a cloth. Talk about what you are doing. Ask the baby to find it. She will have fun lifting the cloth and showing you how much she knows!
- Put the puzzle together as the baby watches.
- Make up a story about the puzzle. Does it look like a boat? or a bird? Where is it going?



What To Look For

- Babies can reach for an object.
- Babies can find an object hidden under a cloth.
- Babies can hold two small things at the same time.
- Babies can listen to a simple story.



Possible extension

Take the puzzle apart. Put all the pieces in an empty container. Let the baby empty the container. Ask her to put all the pieces back in the container again.

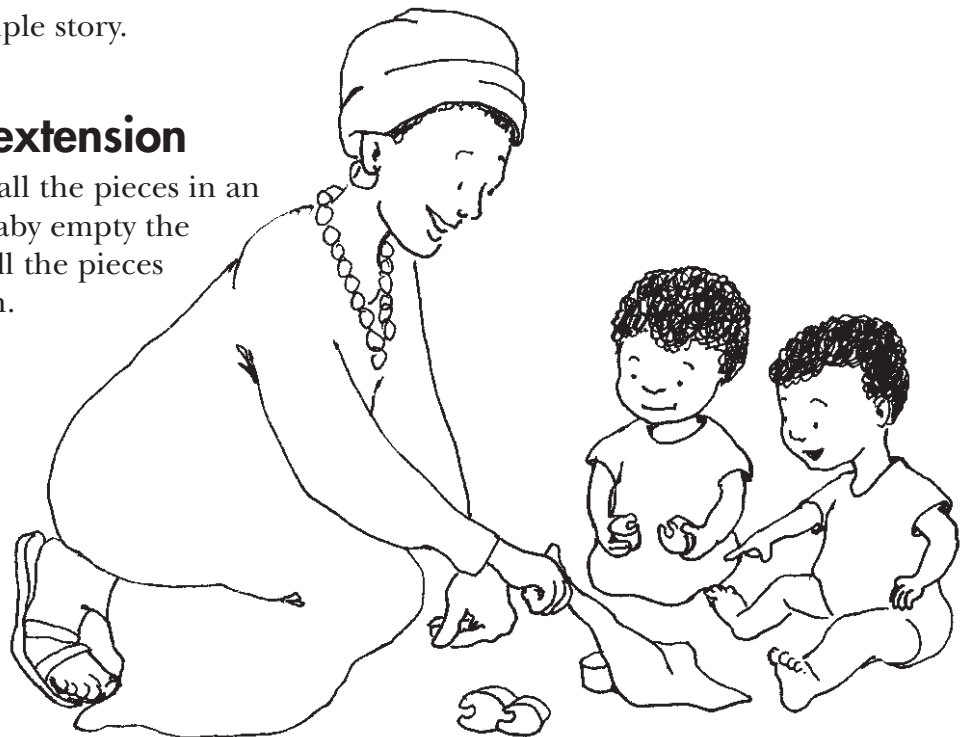

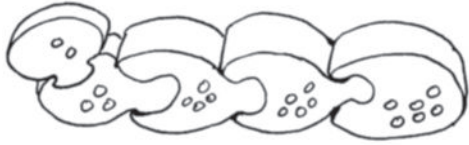

Chain Puzzle

1–3 years



What You Can Do

- Let the children play freely, taking the puzzle apart and putting it back together again.
- Talk about the colors of each piece. Can you find the red one? Let's add the green one to the chain. Talk about the different colors in your clothes. What color is the child wearing?
- Count each piece as the child completes the chain puzzle.
- Make a chain of three pieces. Point to and say the number of each piece as you play. Repeat this many times, making chains of different sizes.
- Try making up a counting song or color rhyme about the puzzle.



What To Look For

- Children can take things apart and put them together.
- Children can sing parts of songs and say parts of rhymes.
- Children can follow simple directions.
- Children understand *one* and *two*.
- Children will try to count.
- Children can point to colors when named.



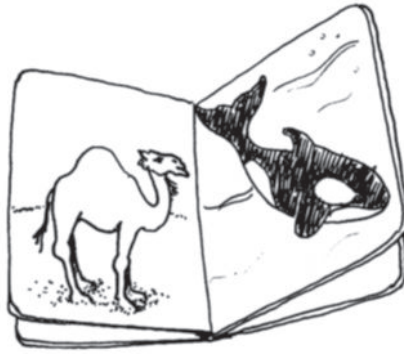

Board Book

3

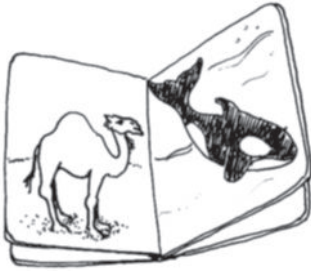

Board Book

Babies



What You Can Do

- Talk to infants as much as you can.
- Listen to all the sounds infants make and talk back to them.
- Talk about the pictures they see in the book, help them turn the pages. As you look at the pictures, talk about what you see. “What do you think comes next? Can you turn the page and see?” Change pictures often.
- 1–3 month old infants see things best when they are between 8–12 inches away. By 3 months, infants have a greater range of vision.



What To Look For

- Infants become emotionally, physically, and mentally relaxed.
- Infants are encouraged to engage with an adult, developing their curiosity.



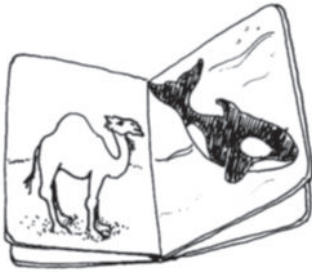

Board Book

1–3 years



What You Can Do

- Look at picture books with a child or several children together.
- Ask simple questions about pictures to help children use or show understanding of words. Point to the picture and say the word together with the children.
- Name one thing you see on the page and try to engage children's curiosity.
- Talk about colors; count the objects pictured in the book, favorite things.
- With storybooks, ask children what they would have done in a similar situation, what would have happened if the ending had been different, etc.



What To Look For

- Developing curiosity and learning new things.
- Children can stand, turn some pages of the book.



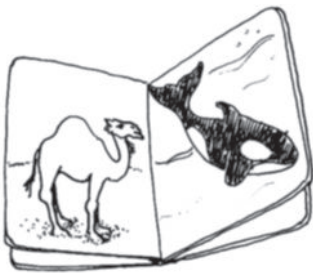

Board Book 4–6 years



What You Can Do

- Sit in a group and display the board books in front of children.
- Ask children what they see and what they can find in the pictures in the books.
- Ask children to point to some of the pictures. If the children cannot show you, try to find the pictures together.
- Ask the children to tell a story about the pictures, or to say what they think about them.
- Ask the children to find and name objects in their environment that look like the pictures.



What To Look For

- Children communicate with caregivers and/or other children.
- Children have fun and enjoy talking about what they see in the book.

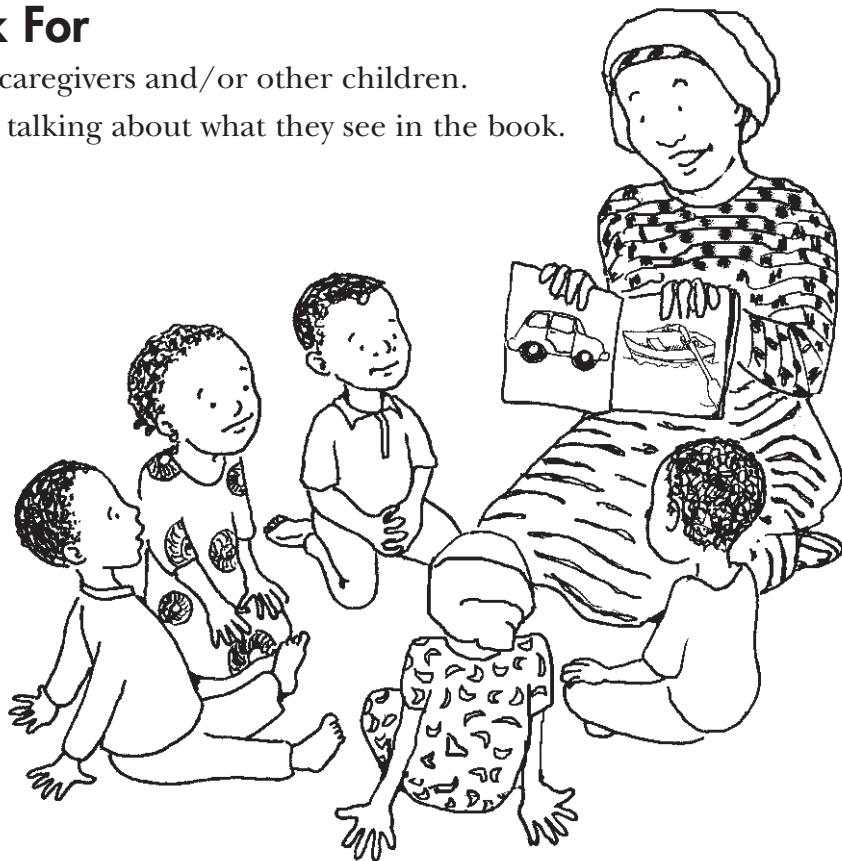



Sponge Balls

4

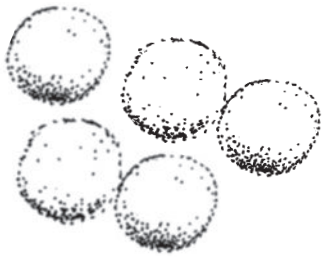

Sponge Balls

Babies



What You Can Do

- Roll a ball to the infant. Let her/him observe how ball rolls on the floor.
- Allow infant to touch and hold the ball; touch is how infants learn about the world.
- Infants enjoy holding and feeling things of different textures. Let them feel the soft ball. This will help them want to move and strengthen their muscles.



What To Look For

- Infants increase their control in handling the ball.
- Infants develop their sense of curiosity.
- Infants interact with caregivers.



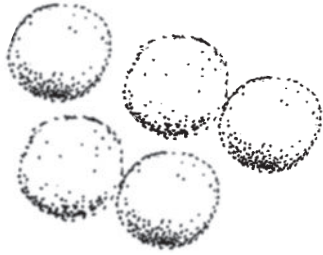

Sponge Balls 1–3 years



What You Can Do

- Partially hide the ball close to child. Encourage child to find the ball. As the child gets used to the game, play it again, this time hiding the ball completely.
- Roll ball to child. Ask child to send the ball back to you. Laugh together and hug as child does so.
- Let children kick, throw, and catch balls.



What To Look For

- Children increase motor control by handling the ball.
- Children stoop and pick up a ball.
- Children learn about concentration and precision.
- Children play together and interact with caregivers.



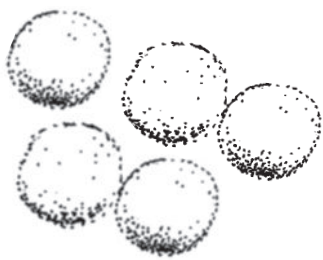

Sponge Balls 4–6 years



What You Can Do

- Let children kick, roll, throw, or bounce balls to one another.
- Put a large basket in the middle of the floor. Show children how to drop or toss the ball into the basket.
- Organize different games where children can play together in teams using the ball.



What To Look For

- Children increase their control in handling the ball.
- Children engage in communications with caregivers and/or other children.
- Children can self-direct physical activities and have fun with the balls.



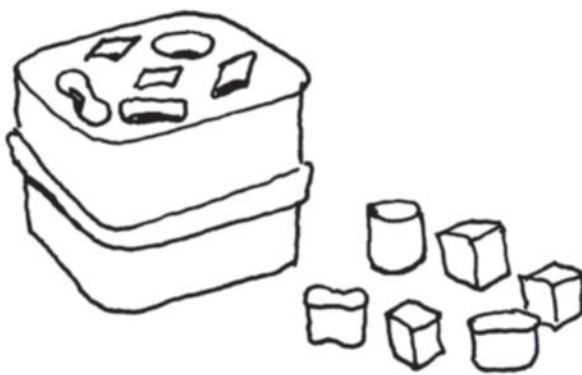

Shape Sorter

5

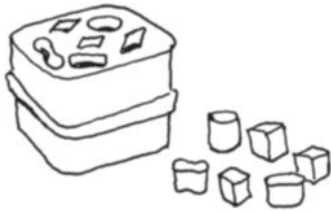

Shape Sorter

Babies



What You Can Do

- Display the shape sorter and different colored shapes in front of the infants and let them play with them freely.
- Talk about what the infant is doing and let her/him handle the objects.
- Let the infant discover how to open the basket. Empty the basket of the shape sorter and ask the older infant to refill it.



What To Look For

- Infants improve hand-eye coordination.
- Infants increase control in handling objects.





Shape Sorter

1–3 years



What You Can Do

- As children play with and dump out the shapes, let them explore how each piece fits in its own hole.
- Name the shape of the piece the child handles and ask him/her to find the corresponding hole in the container.
- Let children learn how to turn their hands and wrists as they try to put a piece in the basket.



What To Look For

- Children learn different colors and shapes.
- Children reinforce their understanding of spatial orientation and cause and effect.





Shape Sorter 4–6 years



What You Can Do

- Let the children practice and enjoy the shape-sorter on their own.
- Organize two teams and ask boys and girls to insert the shapes into the basket one by one as quickly as possible.
- Have all the shapes on the floor, name the shapes, and ask children to show you where the rectangles are, where the triangles are. If they cannot find them, show them and ask the children again to find them.



What To Look For

- Children self-check their ability to match piece shapes with basket holes.



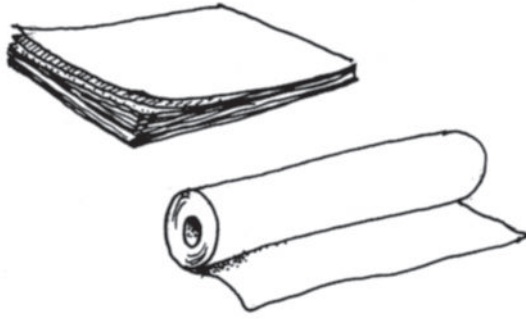

Paper and Crayons

6

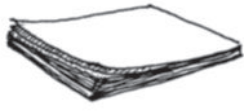

Paper and Crayons

Babies



What You Can Do

- Cut some shapes of different sizes (e.g., circles, triangles, squares) from the colored paper. Punch a hole in each design and string a brightly colored ribbon through the hole. Hang these so the infant can watch them move.
- Talk about the colors and shapes as the infant watches them move.



What To Look For

- Infants develop sense of curiosity.
- Infants try to touch and catch or pull the objects dangling above them.
- Infants smile and make sounds.





Paper and Crayons 1–3 years



What You Can Do

- Provide children with jumbo crayons and paper. Let them explore how to hold the crayons the best way and draw on the paper.
- Let the children draw what they want to.
- If possible, post the children's art on the wall.



What To Look For

- Children express themselves through drawing.
- Children develop their creativity and dexterity by handling crayons and paper.
- Children learn about colors and shapes.



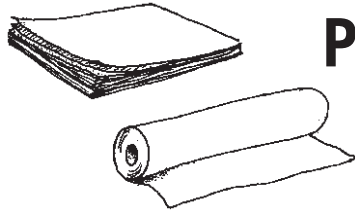

Paper and Crayons

4-6 years



What You Can Do

- Let children draw or write what they want on the paper.
- Let children present and describe their drawing and help children to listen while one of them presents.
- Let children explore how to fold the paper to make paper shapes (boat, box, hat, basket, house, animal, etc.); show them how to cut paper into strips and how to make a collage from paper scraps.
- Let children copy letters or numbers when appropriate.



What To Look For

- Children develop their creativity.
- Children express themselves through the art of drawing.
- Children develop dexterity in handling crayons and paper. They learn how to use more than one material together.





Stringing Beads

7



Stringing Beads

Babies



What You Can Do

- Put beads of different sizes and colors on the ends of several strings. Tie the strings tightly to keep the beads from coming off. Lay one of the strings out in front of where the infant is sitting. Show her how to pull it so that the toy moves toward her/him. Give her/him the string to pull and talk with the infant about what she/he is doing.



What To Look For

- Infants develop their sense of curiosity.
- Infants try to touch and catch or pull the objects hanging on top of their head. ?
- Infants express their happiness, smile and make sounds.





Stringing Beads 1-3 years



Note: Adult supervision is important when necklaces are used during play.



What You Can Do

- Put a set of colorful beads where children can play with them freely.
- Encourage the child to put beads on the string by colors and/or shape. Count with the child how many beads he/she strung.
- Congratulate the child for the necklace or bracelet that he has created.



What To Look For

- Children learn about different colors.
- Children increase their control in handling objects and develop dexterity.





Stringing Beads

4–6 years



Note: Adult supervision is important when necklaces are used during play.



What You Can Do

- Organize children into two teams and ask them to complete a necklace with one color as quickly as possible.
- Congratulate participants and ask others to participate as well.
- Let the children string the many kinds of objects in their own way. Talk with children about the things they have chosen to string.



What To Look For

- Children develop fine motor skills by creating necklaces, bracelets, etc.



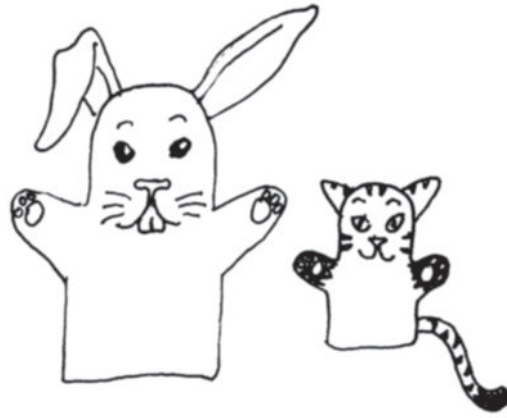

Puppets

8



Puppets

Babies



What You Can Do

- In the hands of a creative and responsive adult, puppet play offers an ideal opportunity to present difficult themes and issues.
- Put a puppet on your hand and make it talk to the infant. Use a different voice as you make the puppet talk. Have the puppet tell the infant about itself.
- Let the infant touch the puppet as it talks. Laugh and have fun. Let the infant play with the puppet.



What To Look For

- Infants feel secure with a friendly puppet that they can handle themselves.
- The infant who fears danger may try to master this fear through doll play that enacts scenes of comfort and nurturance.
- In doll play, infants frequently identify with both infant and nurturer.





Puppets

1-3 years



What You Can Do

- Use animal puppets to talk with and sing with children. Talk about the animal, his name, and the sound he makes. Try making up songs like “Where is the cat? Here he is. What does he say? Meow, meow.”
- Have the puppet ask a child questions that you think she/he might be able to answer. Have fun and be silly with the puppet as it asks about the child’s name, clothes, body parts, etc.
- Let children play with the puppets among themselves and make up their own stories and songs.



What To Look For

- Children and caregivers share stories and develop imagination with their puppets.
- Children talk to their puppets and learn how to take care of them like a friend.
- Puppets provide children with an outlet for feelings of helplessness while at the same time providing a way of figuring out solutions to problems.



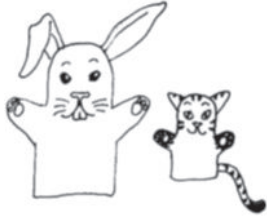

Puppets

4–6 years



What You Can Do

- Have a few children use the hand puppets to help you tell a familiar story. Put a puppet on your hand, and give each child a puppet to hold. Tell each child who his/her puppet will be in the story. Have the children listen carefully so that they will know when to make their puppets talk. Begin telling the story. When the time comes for a child's puppet to say something, give help if needed.
- Children may use the puppets to play out events that have occurred, both happy and sad, and may want to discuss such events with the caregiver.



What To Look For

- Children interact together and share stories, developing their imagination and expressing their feelings.
- Children can talk to their puppets and learn how to take care of them.
- Children express their happiness in movement and sound.

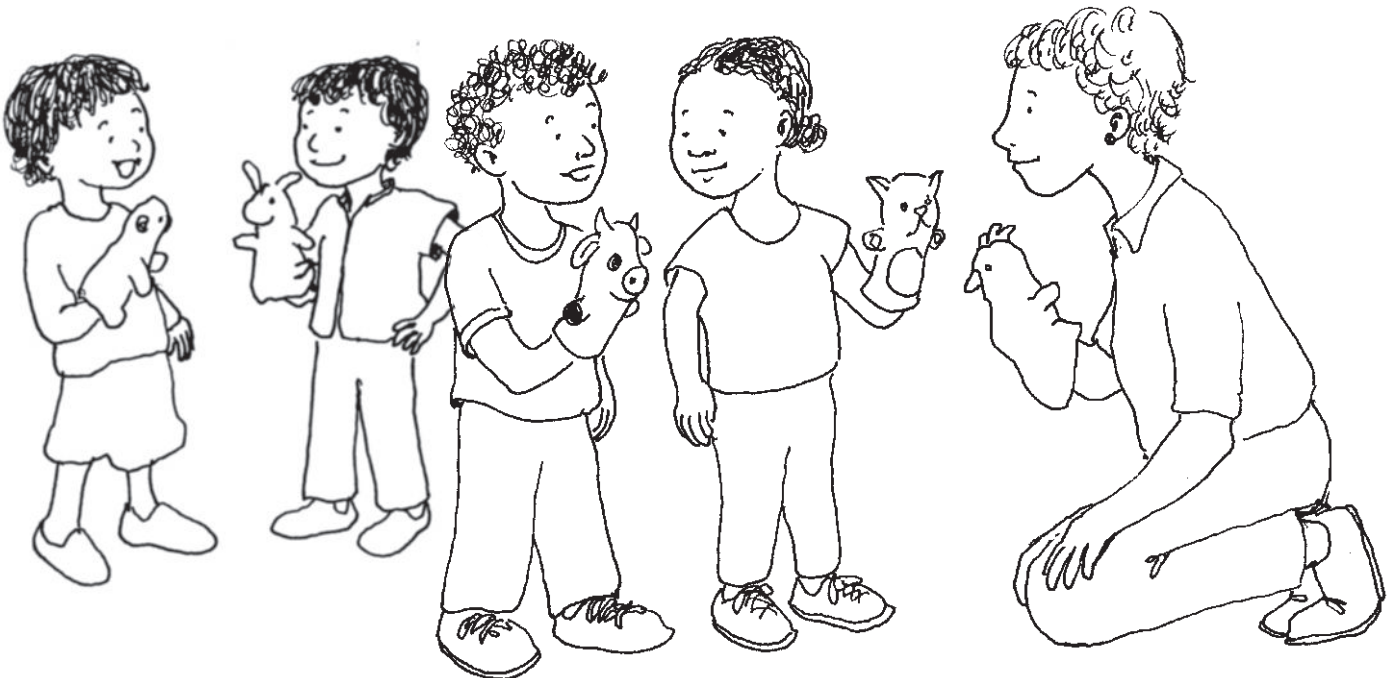



Stacking and Sort Kit

9

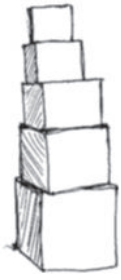

Stacking and Sort Kit

Babies



What You Can Do

- Put one object down in front of baby and stack another on top as she watches. Give baby one to stack.
- Talk about what she is doing.
- Give her time to explore these materials freely.



What To Look For

- Babies can put one thing on top of another.
- Babies show interest in something new.



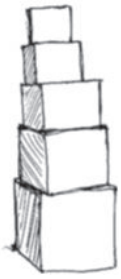

Stacking and Sort Kit

1–3 years



What You Can Do

- Place the stacking kit in the middle. Let children play freely with the materials. Watch how they explore a new object. Let them put the objects on top of each other. Encourage children to stack them in their own way. It is fine if it is not in the right order. This skill will come later.
- Talk about how the objects look. Talk about each object's color, size, and shape, and how some are small and others are big. Show the children how to stack the objects. See if they will imitate you.
- Choose one item and see if the child can find another one just like it. Ask children to find all the items of the same color.



What To Look For

- Children will try to imitate you.
- Children will notice different sizes.
- Children will compare what is bigger and what is smaller.
- Children will do easy sorting.



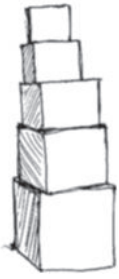

Stacking and Sort Kit

4–6 years



What You Can Do

- Encourage children to sort the items in their own creative ways.
- Using these stacking/sorting items, ask children to order the objects according to color, size or shape.
 - Find all the items that are the same size.
 - Find all the items that are the same shape.
 - Make a line of items from the smallest to biggest.
 - Make a pile of all the same color.
- How many items are in the different groups? What is the biggest group? What is the smallest group?

Let children stack the items. Talk together about what they did. Then try asking these questions:

- Which was the biggest container?
- Which was the smallest?
- How did you figure out how to fit them all inside the biggest container?

Ask children to count the number of items in each group.



What To Look For

- Children show interest in numbers, shapes and sizes.
- Children can count 10 or more objects.
- Children can sort items by different features, each item in a group sharing one feature.
- Children understand the words *one* and *many*, *less* and *more*.
- Children can compare sizes.

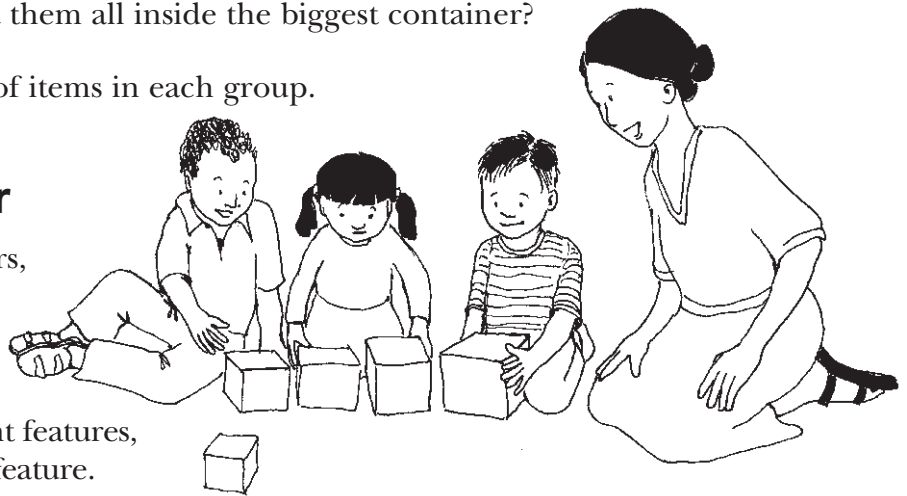

Possible extensions

- Give pairs of children six items. How many groups of 2 can you make with these six items? (three) How many groups of 3 (two)? 4 (one with two left over)? 5 (one with one left over)? and 6 (one)?
- Ask children to make other groups using different items. Ask them to talk about why they made these groups.

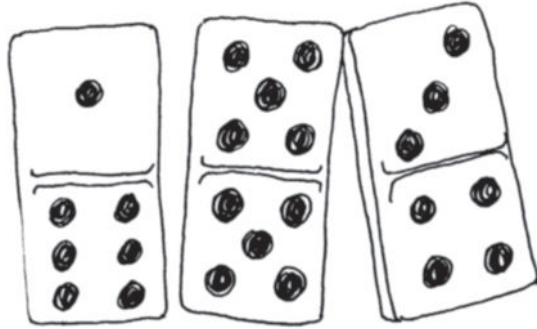

Dominoes

10

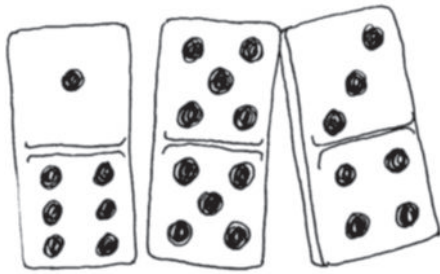

Dominoes 1-3 years



What You Can Do

- Let children play freely with the dominoes. Ask them questions about what they are doing. They may try to stack them in piles, line them up, or make a pattern.
- Using several dominoes, create interesting designs and shapes. Ask children to try to match your designs.
- Count the number of dots on a domino. Ask children to find another domino with the same number of dots on one side.



What To Look For

- Children are able to copy patterns.
- Children are able to count and match dots.
- Children know the names of numbers.



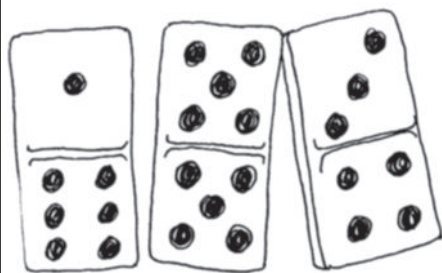

Dominoes 4–6 years



What You Can Do

Games help children learn about numbers. Here is one to try.

- Sit in a circle and give each player five dominoes. Put the rest in a pile in the middle of the circle.
- The first player puts down one of his dominoes.
- The next player must attach a domino to the one in the middle matching the number of dots. If he can't make a match, he takes a domino from the pile.
- The next player either plays one of his dominoes or takes one from the pile if he doesn't have a match.
- Continue playing until one player is out of dominoes.



What To Look For

- Children are able to understand and follow rules of a game.
- Children can count, match and add dots.
- Children show an interest in numbers and counting.
- Children count from one to twenty.



Possible extensions

- Add the number of dots on each end of the domino. For example a domino with five dots on one end and two dots on the other has a total number of seven dots.
- Ask children to match one end of a domino with the end of another domino with the same number of dots. Count the number of dots.
- Ask older children to help make up other number games to teach to children.



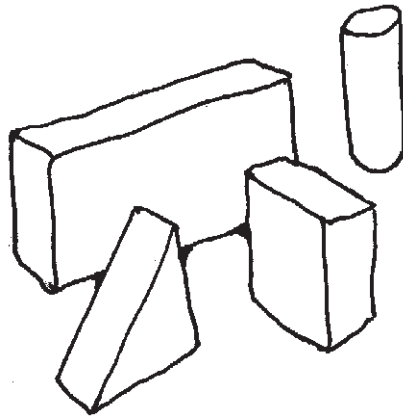

Construction Blocks

11

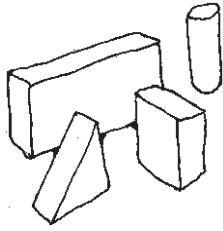

Construction Blocks

1-3 years



What You Can Do

- Put a set of colorful blocks where children can play with them freely. Let the children dump all the blocks in a pile and play with them as they wish.
- When the child picks up a block, talk to her/him about the color and shape of the block. Ask the child to pick up another block with the same color or shape. If the child picks up another color or shape, name the new color or shape he/she just picked up.



What To Look For

- Children learn different colors and reinforce their hand-eye coordination.
- Children increase control in handling objects and develop dexterity.



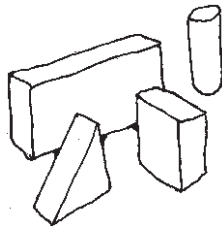

Construction Blocks

4–6 years



What You Can Do

- Put a set of colorful blocks where children can play with them freely. Ask child to assemble blocks together as a house, bridge or any other construction.
- To promote cooperation, give each child a block to build a structure together. Let each child place his/her block one at a time until a structure is built.



What To Look For

- Children try to build more complicated shapes and figures.
- Children understand more about size and shape and what happens when they add too many blocks!



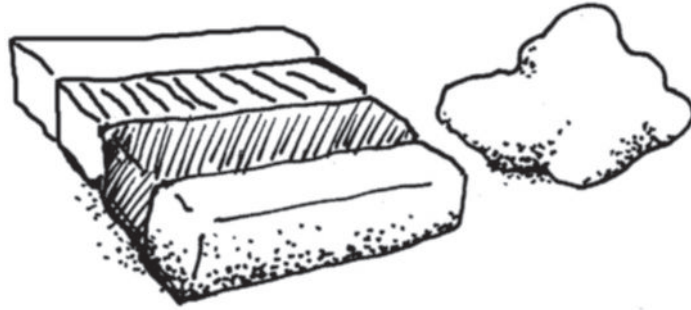

Modeling Clay

12



Modeling Clay

1–3 years



What You Can Do

- Put a box of colorful modeling clay out for the children. Let the children play freely and discover how to shape the clay.



What To Look For

- Children learn different colors and reinforce their hand-eye coordination.
- Children develop dexterity and creativity, and increase their control in handling objects.





Modeling Clay

4–6 years



What You Can Do

- Put a box of colorful modeling clay out for the children. Let children create shapes and figures.
- Encourage children to experiment with combining natural items and clay.
- Let children make individual constructions with the clay and share the clay figures. Emphasize the process, not the product.



What To Look For

- Children develop their understanding of spatial orientation and cause and effect.
- Children self-conduct the activity and assemble and build figures with the blocks.
- Children explore and develop their creativity.



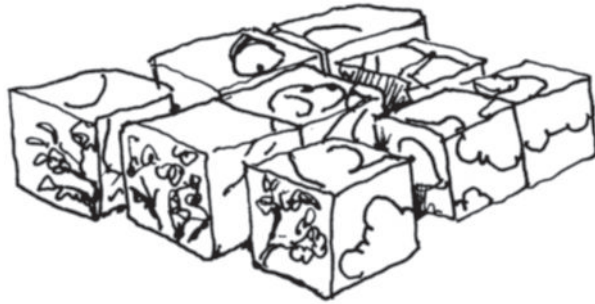

Puzzle Blocks

13

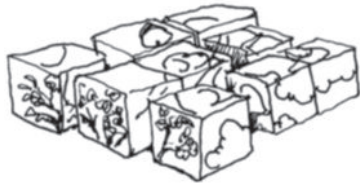

Puzzle Blocks 1–3 years



What You Can Do

- The caregiver explains to the children that these puzzle blocks have pictures on them, and different sides of each cube may be put together to make a different whole picture.
- Let a child or a group of children complete the puzzle and memorize where each piece is supposed to go.
- Form a group of children and challenge them to complete the puzzle as fast as they can. All participants are invited to contribute to completing the puzzle.



What To Look For

- Children concentrate and are quiet, but their minds are expanding. Puzzles provide children with opportunities to think and reason. Children focus and be themselves.

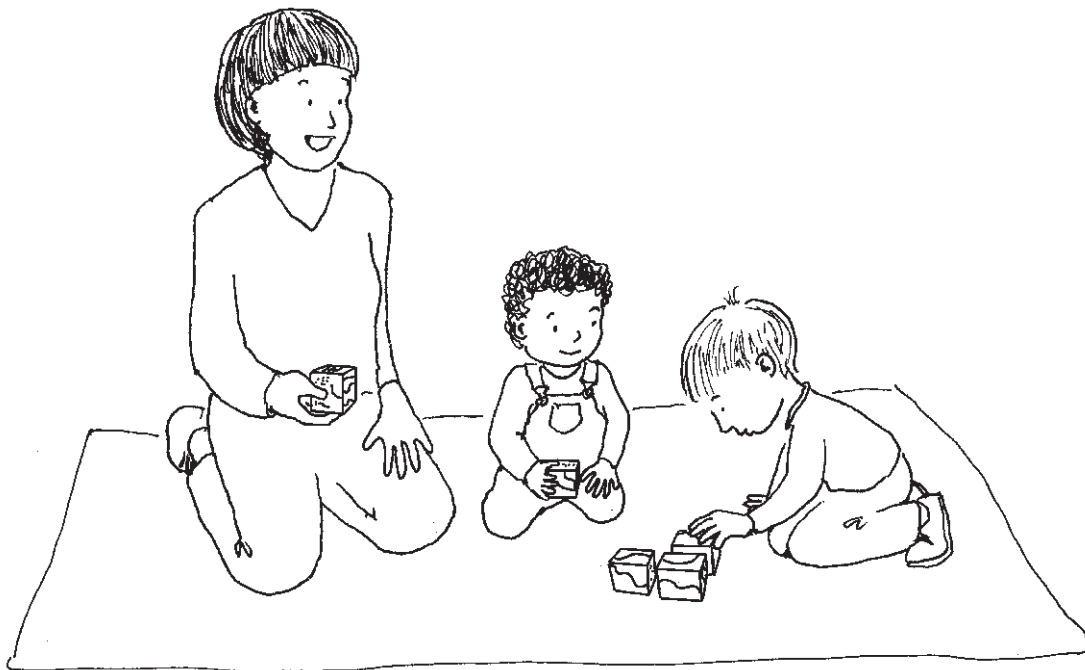

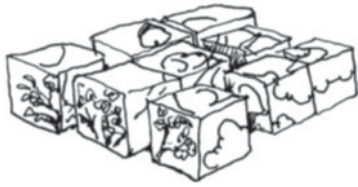

Puzzle Blocks

4–6 years



What You Can Do

- Ask a child or a group of children to complete the puzzle and memorize where each piece is supposed to go.
- Form a group of children and challenge them to complete the puzzle as fast as they can. All participants are invited to contribute to completing the puzzle.



What To Look For

- Children concentrate and are quiet, but their minds are expanding. Puzzles provide children with opportunities to think and reason. Children focus and get down to the work of being a child.





Memory Game

14



Memory Game

1–3 years



What You Can Do

- Place all cards face down. Each player then picks two and turns them over so other players can see the face and where the card is located on the table. If they do not match, cards are placed face down again in the same location and the next player takes a turn. If they do match, the player keeps the pair. As the game is played, everyone sees the images on each card and their location, and players can begin to memorize where the matching cards are on the table. They can then choose matching pairs of cards from memory and keep the pairs that they match. The player with the most matching cards wins.
- Let the children dump all the cards in a pile and play with them.
- Ask children what cards they like the most and why. Encourage children to talk about the pictures of the cards and let them play with the cards freely.



What To Look For

- Children become engaged—they want to learn more about the cards.
- Children learn about their environment, developing their imagination and learning more about the world surrounding them through the pictures they see in front of them.





Memory Game

4–6 years



What You Can Do

- Place all cards face down. Each player then picks two and turns them over so other players can see the face and where the card is located on the table. If they do not match, cards are placed face down again in the same location and the next player takes a turn. If they do match, the player keeps the pair. As the game is played, everyone sees the images on each card and their location, and players can begin to memorize where the matching cards are on the table. They can then choose matching pairs of cards from memory and keep the pairs that they match. The player with the most matching cards wins.
- Put a set of colorful cards where children can play with them freely. As the child picks up a card, talk to the child about the card that he/she picked up.
- Ask the child to pick up another card with the same picture. If the child picks up a card that does not match the previous one, tell him/her what the new card is that he/she just picked up. Ask the child to match the cards side by side by theme/content.



What To Look For

- Children self-conduct the activity; they develop ability to recognize similarities and differences, categories, logic.
- Children develop their creativity by assembling the cards on their own. They learn more about the world surrounding them through the pictures that are displayed in front of them.

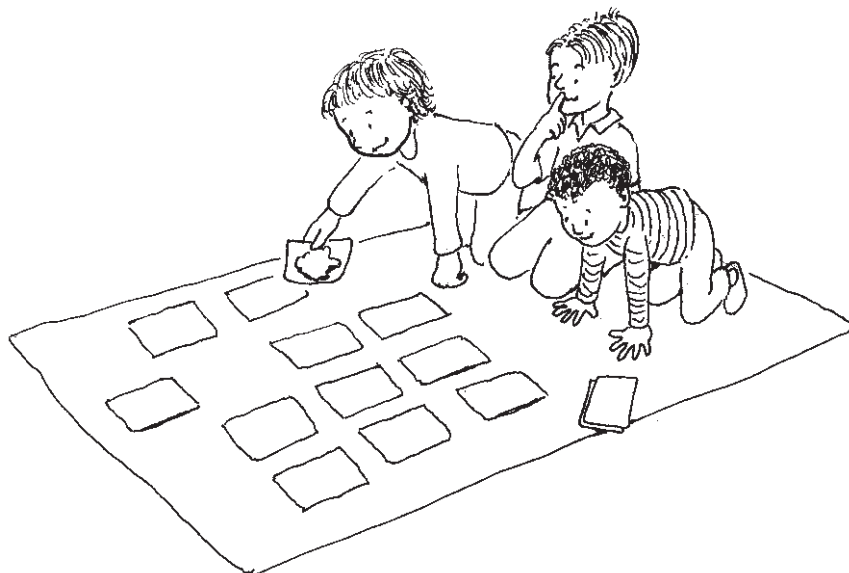

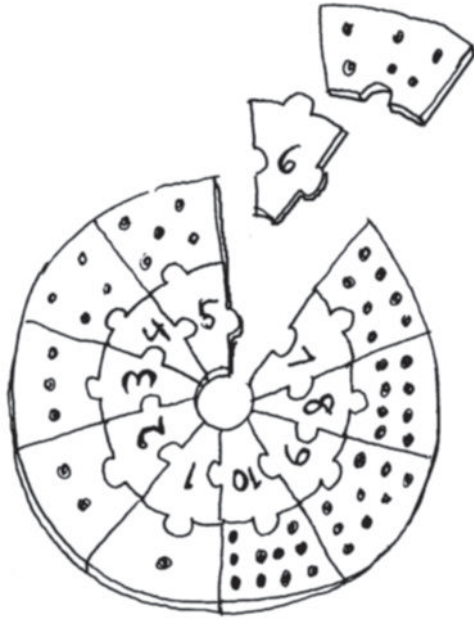

Counting Circle

15



Counting Circle 4–6 years



What You Can Do

- Ask children to put the puzzle together. Talk about the number of pieces in the puzzle. Help them to learn numbers by pointing to and counting the number of dots for each piece.
- Give one piece of the puzzle to each child. Ask them to find their match (five-dot piece finds the number 5 piece). Ask children to line up according to their number/dot match. Then ask children to complete the circle puzzle, adding each pair number in order.
- Give the children lots of practice counting everything. How many little children? How many older children? How many caregivers? Which is the biggest group?
- Write out the numbers 1–10 on cards, one card for each number. Give each child a card. Ask them to find the puzzle piece with the same number of dots.
- Use cards, puzzle pieces, and even children to help children learn simple addition and subtraction. For example, sit in a circle. Ask five children to stand up. Ask one child to sit down. How many children are still standing?
- Ask a child to find the puzzle piece with three dots. Ask another child to find the piece with two dots. Count the number of dots. How many do you have now? (5) Can you find the puzzle piece with the number 5? Repeat this many times.
- Make up silly songs and rhymes using the numbers 1–10. Here is one to get you started: “If you divide me into two piles of objects and each pile has a 2 in it, what number am I? (4)



What To Look For

- Children show interest in counting.
- Children can count up to 10; count up to 20 objects.
- Children can name written numbers from 1–5.
- Children can name written numbers from 6–10.
- Children understand the words *one* and *many*; *less* and *more*.
- Children begin to understand that adding and subtracting changes numbers.

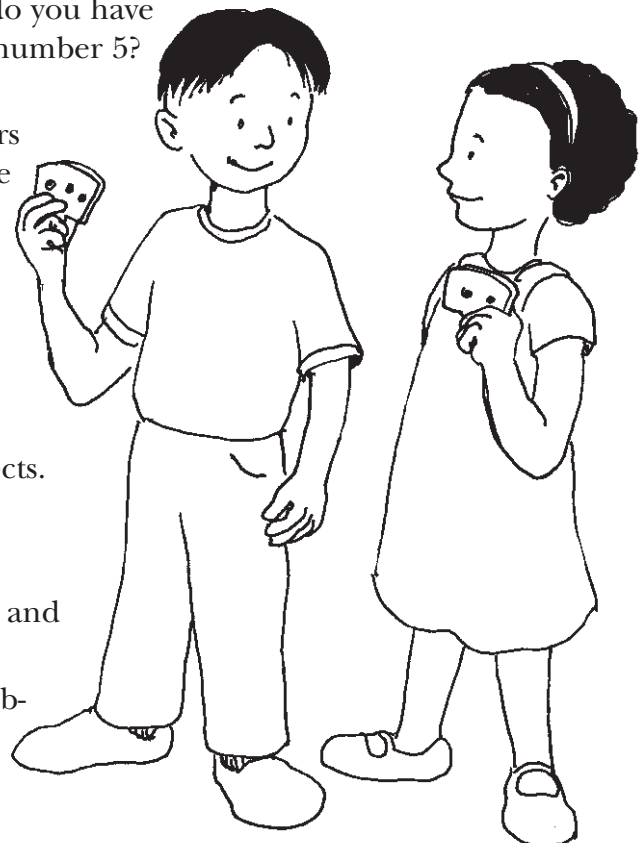

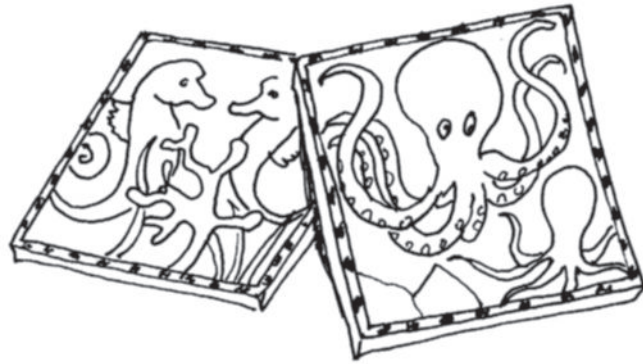

Jigsaw Puzzles

16



Jigsaw Puzzle

4–6 years



What You Can Do

- Let a small group of children take the puzzle apart and put the pieces back together. Help children if it is too difficult.
- You can use words to help the children see the next step, move a piece just a little until the child sees the answer.



What To Look For

- Children show interest in counting.
- Children can count up to 10; count up to 20 objects.
- Children can name written numbers from 1–5.
- Children can name written numbers from 6–10.
- Children understand the words *one* and *many*; *less* and *more*.
- Children begin to understand that adding and subtracting changes numbers.



Possible extensions

- Children can control hand and finger movements quite well.
- Children can play cooperatively with friends in a small group.
- Children can use words and imagination to talk about the puzzle.



1 • We Are Going to...

Babies–3 years

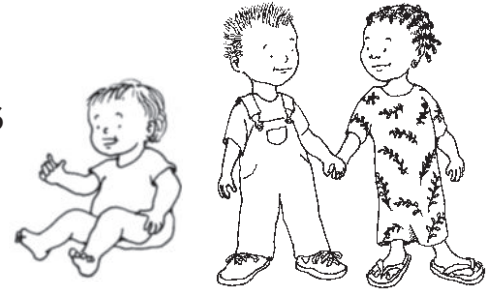

While nurturing infants and young children, talk or sing to them. Let the infants and young children know what will be happening next.



What You Can Do

- Choose a familiar melody and sing the following: “We are going to go outside, we are going to go outside, we will play, laugh, and have some fun, and we are going to go outside.”
- Hold and hug your infant and young children several times a day.



What To Look For

- Infants and young children increase their social skills, become more curious and self-confident.
- Infants and young children feel secure.
- Infants and young children interact with others and caregivers, which helps them grow more social, learn more easily, have greater self-esteem and self-confidence.



Possible extension

- Model and explain positive behavior to your infant or young child. Infants and children learn through interaction and by copying your behavior.
- Encourage your older infant and young child to play and interact positively with other children.
- Make up songs about the infants’ and children’s names, saying something nice about each child.



Caution

- Infants and children should always be under the supervision of responsible older caregivers.
- Ensure that infants and children do not engage in dangerous activities and that they are not left alone.
- Never use physical or verbal punishment to correct your infants’ and children’s behavior.

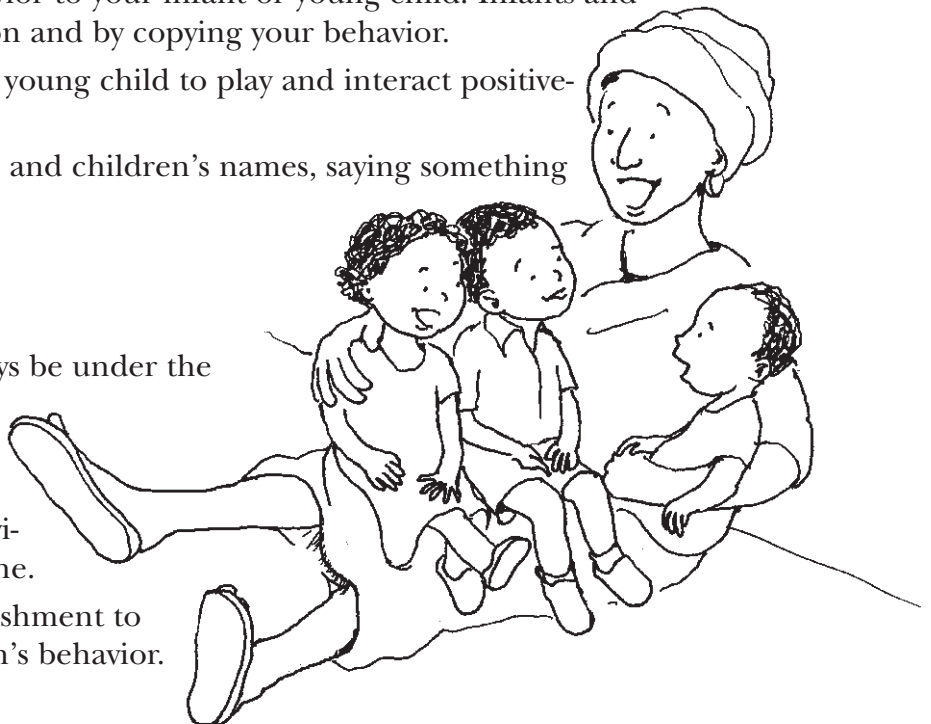

2 • We Can Move

Babies–3 years

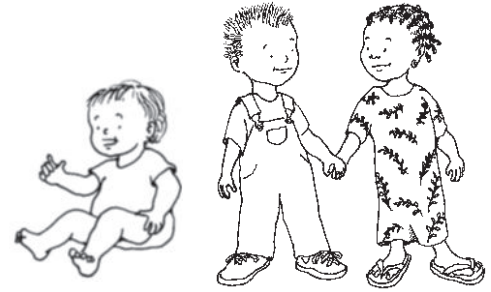

What You Can Do

- Have two children hold hands to make a tunnel. Encourage your infants and young children to crawl through the tunnel. They could also be a tree, a mountain . . .
- Put yourself on the same physical level (crouch down so you are face to face) as your infants and young children to help with communication.
- Always smile and display a genuine interest in caring for the infants and young child.

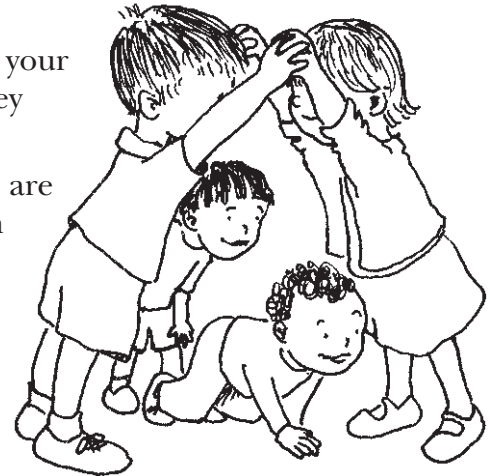

What To Look For

- Infants and young children increase their ability to recognize and analyze situations and objects.
- Infants and young children improve their ability to balance; they learn how to sit, kneel, and crawl by using different body parts.
- Infants and young children have an opportunity to have fun with their caregivers, thus building self-confidence and basic trust.



Possible extension

- Select children to be leaders in other activities such as helper, to pass out, to collect materials, to greet guests, etc.



Caution

- Infants and children should always be under the supervision of responsible older caregivers.
- Ensure that infants and children do not engage in dangerous activities and that they are not left alone.
- Never use physical or verbal punishment to correct your infants' and children's behavior.



3 • Familiar Sounds

Babies–3 years

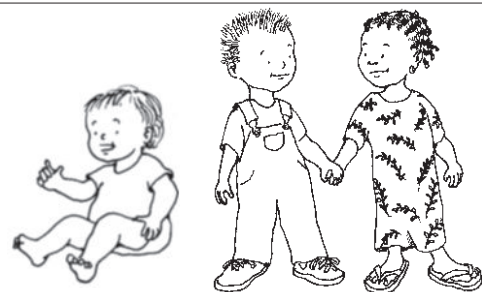

Talk to infants and young children so that they can hear and copy your words. Listen to and repeat what they tell you. Infants and young children learn more when the adult looks into their eyes while talking.



What You Can Do

- Talk to infants and young children as much as you can. This helps them learn to talk more easily when they are ready.
- Remember a sound an infant likes to make, such as *ba, ba* or *ma, ma*. When he/she is quiet, say the sound to the infant. See if he/she will answer you with the same sound.
- Change the sound a little by making it quiet or loud, fast or slow, high or low.
- Watch the infant's face to see what he/she thinks of these changes.



What To Look For

- Infants and young children's faces change according to the different sounds you make.
- Infants and young children babble a string of sounds.
- Infants and young children copy a sound you make.
- Infants and young children show delight by laughing or squealing.

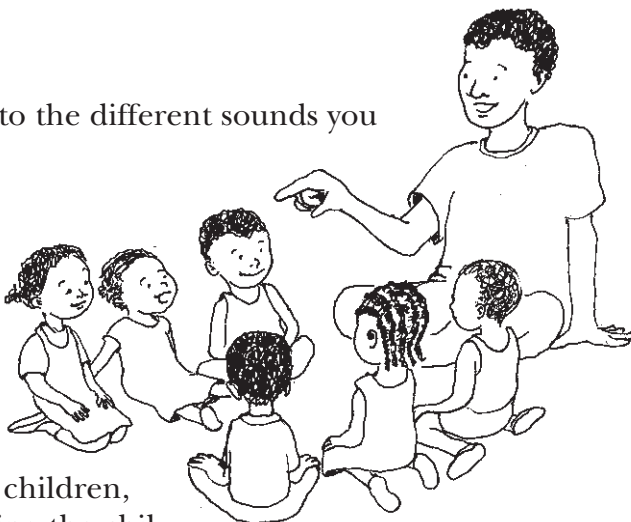

Possible extension

- While sitting with a small group of infants and young children, choose someone's name and sing a simple melody using the children's names. "Where is Kamala?" (Point to the child.) "There she is! This is Kamala."
- Place the infant on his/her stomach. Sit near the infant and slowly creep your fingers toward him/her. "Here come my fingers. Here they come. Closer and closer. They got you!"
- To change the game, make your fingers creep slowly, then quickly, or wait different amounts of time before tickling the infant.
- Teach young children songs that include their family name, village, and contact information.



Caution

- You should never say sounds or sing too loudly; this might scare the children.
- Smile as much as possible and provide the infants and young children with comfort and trust.



4 • Can You Copy Me?

Babies–3 years

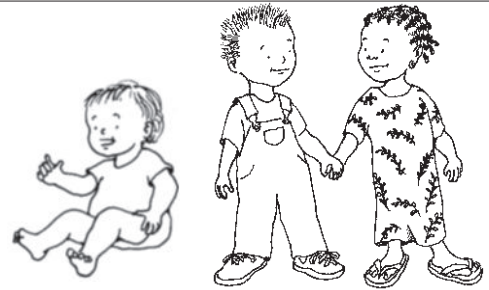

Even the tiniest infants listen when they are talked to and talk back in their own special ways. They watch as the adult's mouth moves and wave their legs and arms or coo and gurgle in reply.



What You Can Do

- While the infants and young children are sitting, play a little “copy me” game. Do simple actions in front of them and try to get them copy you. For instance, clap your hands, pat your head, and tip your head from side to side. Encourage them: “Clap your hands. That’s right.”



What To Look For

- Infants and young children listen to familiar words.
- Infants and young children imitate your gestures and learn how to move their bodies.



Possible extension

- Point to your eyes, nose, and mouth and do the same on the infant or young child. Take the infant or child's hand and have him/her touch his/her own eyes, nose, and mouth. “See my nose? And here is your nose.”
- Ask the young children to perform a task such as “Make a silly shape”; “Touch your head”; “Tap your foot”; “Jump up”; “Draw circles on your stomach”; etc.
- Ask the young children to mimic your pose, as in “Stand tall like a tree”; “Make yourself as big (or small) as possible”; etc.

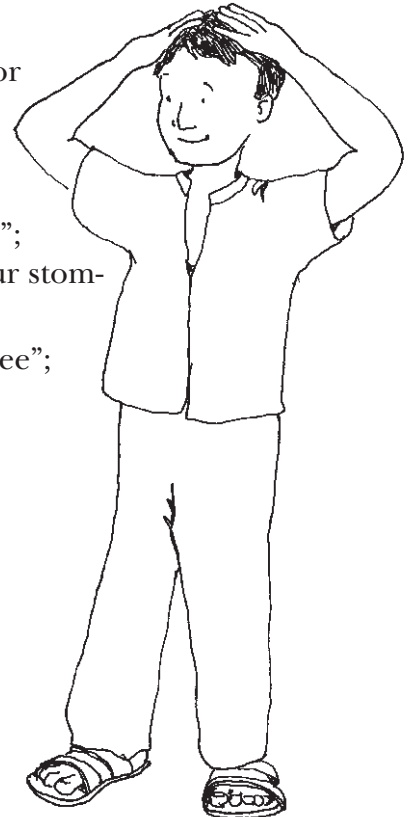

Caution

- You should never say sounds or sing too loudly; this might scare the children.
- Smile as much as possible and provide the infants and young children with comfort and trust.



5 • We Can Make Music

Babies–3 years

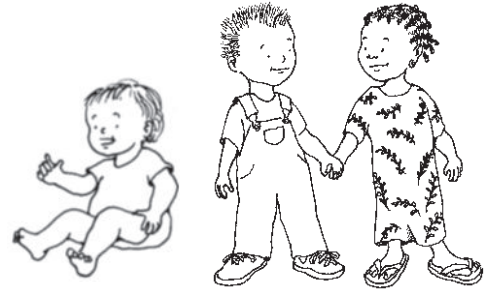

Try to get down to the eye level of the infants and children; this can open or increase communication and interaction with children. Let them know what will be happening next.



What You Can Do

- Tell the young children that they are going to play their body instruments—arms and hands.
- Show them some possible ways of producing sounds with their bodies: clapping their hands, snapping their fingers, clapping their thighs with their hands, knocking on the table or on the floor with their fists.

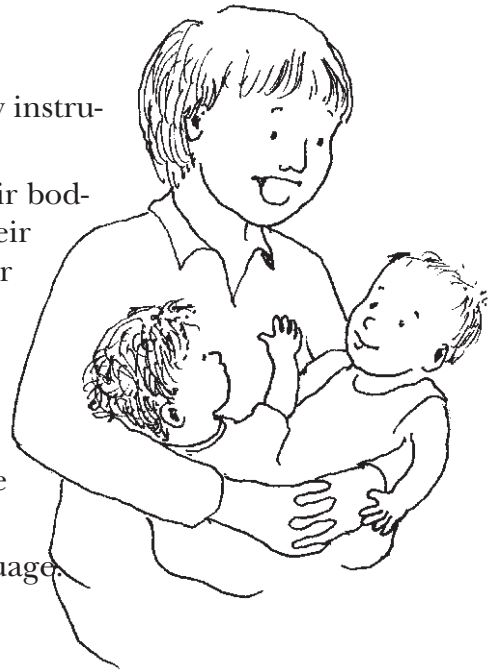

What To Look For

- Infants and young children are able to think of ways to create sound with their bodies.
- Infants and young children repeat the motions and the language.



Possible extension

- Caregiver should sit in a comfortable and safe position facing the infant or child. Begin to clap and say, “Clap, clap, clap your hands.” Create your own rhythm or rhyme following the lead of the infant or child. Ask the infant or child to “clap your hands now. Move your hands, clap . . . clap . . . clap.”
- Create your own song and repeat so the infant or young child can hear it over and over again.
- Hold the infant or young child in your arms and dance or sway while singing familiar children’s songs.

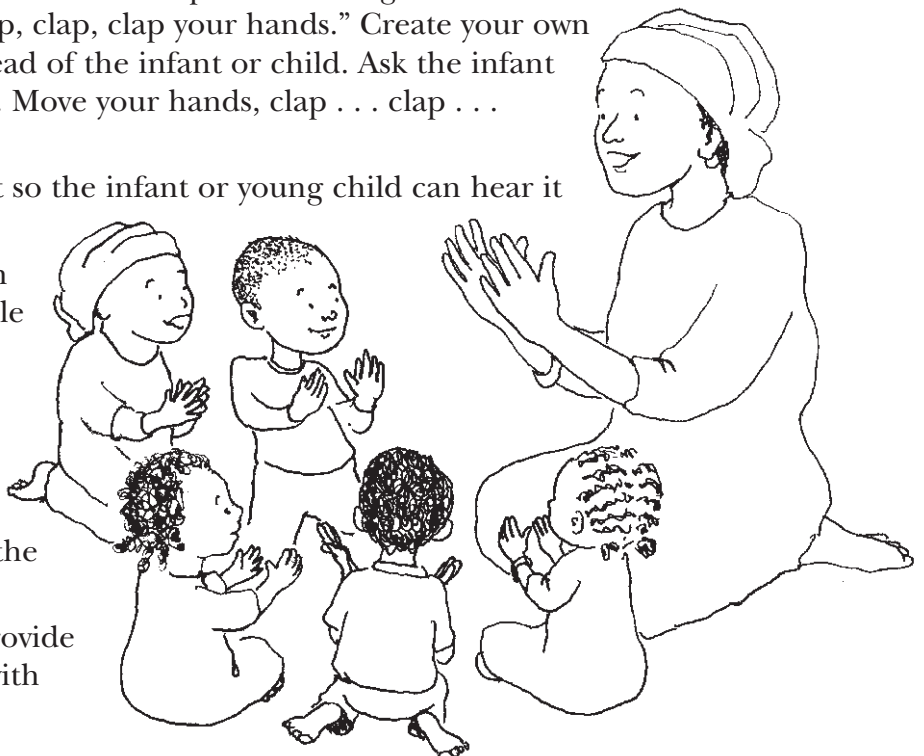

Caution

- You should never say sounds or sing too loudly; this might scare the children.
- Smile as much as possible and provide the infants and young children with comfort and trust.

6 • I Am Here. Babies–3 years Who Is Here?

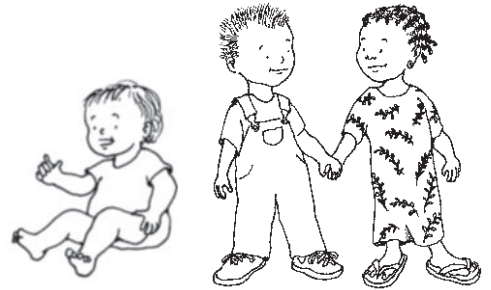

Try to get down to the eye level of the infants and children; this can open or increase communication and interaction with children. Let them know what will be happening next.



What You Can Do

- Call or sing the name of the infant or child. Observe the infant or child to see if he or she is focusing on the voice or sound.
- Sing the verse, “I am here. Who is here?” Sing again, “I am here. Who is here?” but this time, add the infant’s or child’s name and the caregiver’s name.
- Repeat several times while smiling.



What To Look For

- Infants and young children interact with others and caregivers, which enlarges and reinforces their social skills, early learning, self-esteem and self-confidence.
- Infants and young children increase in ability to recognize and analyze.



Possible extension

- Whenever a child enters the room, sing or call out, “Look, (the child’s name) is here,” and then say, “Hi, (the child’s name) is here, and we like to wave to our friends.” Repeat the action several times as other children join in. This can also be repeated for those children leaving the play area.



Caution

- You should never say sounds or sing too loudly; this might scare the children.
- Smile as much as possible and provide the infants and young children with comfort and trust.

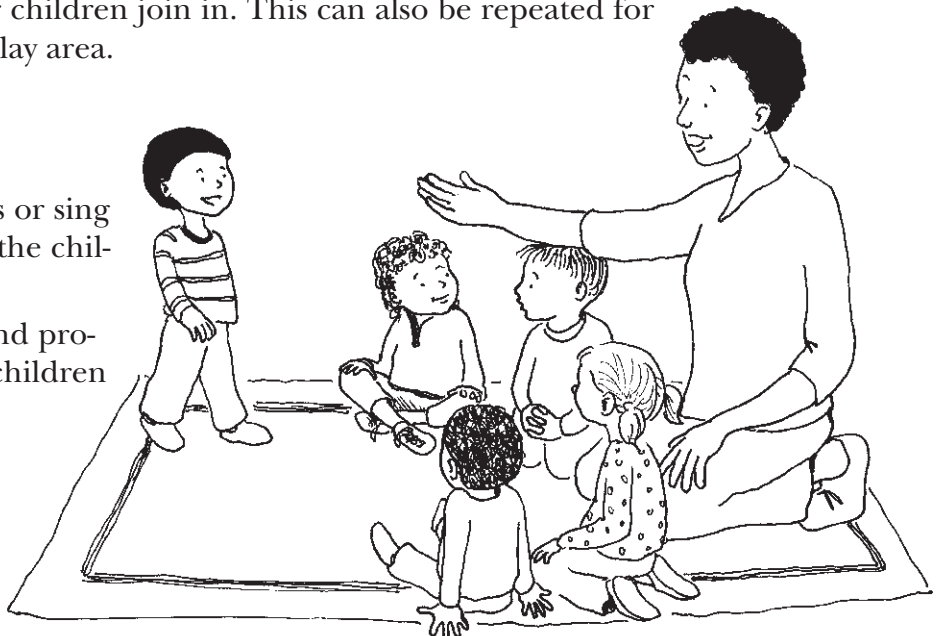

7 • I See Something

Babies–3 years

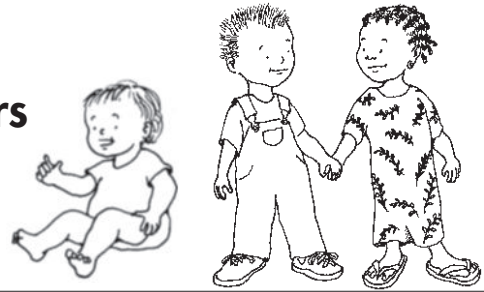

Try to get down to the eye level of the infants and children; this can open or increase communication and interaction with children. Let them know what will be happening next.



What You Can Do

- Pick up or point to different objects around you. Ask, “What do I see?”
- Take a walk with the infant or young child around the room. Encourage the infant or young child to touch all kinds of textures. Talk about the textures as the infant or child touches them.

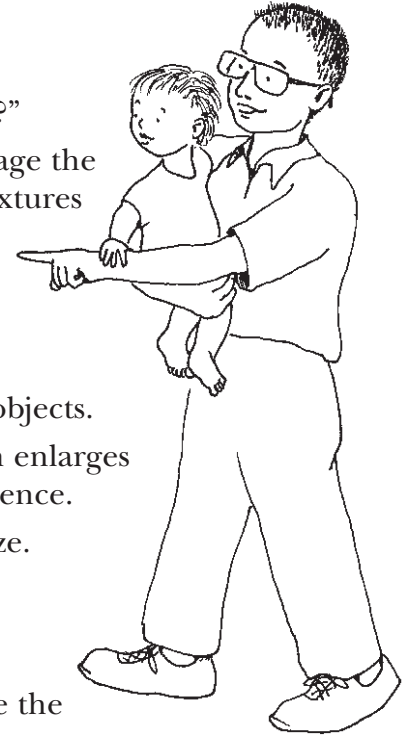

What To Look For

- Infants and young children recognize and attempt to name familiar objects.
- Infants and young children interact with others and caregivers, which enlarges and reinforces social skills, early learning, self-esteem, and self-confidence.
- Infants and young children increase in ability to recognize and analyze.



Possible extension

- Look around the room and ask where familiar objects are. Encourage the older infant or child to look at the named object.
- Walk over to the object and let the young child touch it while encouraging him/her to say the name.



Caution

- You should never say sounds or sing too loudly; this might scare the children.
- Smile as much as possible and provide the infants and young children with comfort and trust.



8 • Quiet Talking Time

Babies–3 years

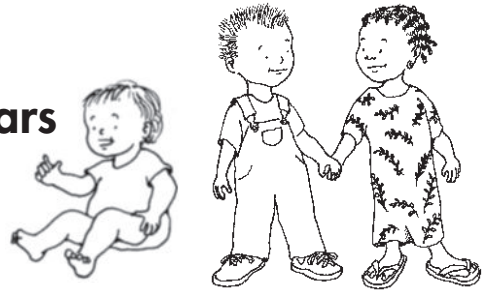

Try to get some kind of eye contact or body contact with the infants and children; this can open or increase communication and interaction with children. Let them know what will be happening next.



What You Can Do

- Set aside a little time to talk with your infant or young child.
- Let him/her sit on your lap, maybe holding hands.
- Talk quietly to the infant or young child about anything that might be interesting.



What To Look For

- Young children say a few words and feel special.



Possible extension

- See how the infant or young child listens to you.
- Add to any word he/she says.



Caution

- You should never say sounds or sing too loudly; this might scare the children.
- Smile as much as possible and provide the infants and young children with comfort and trust.

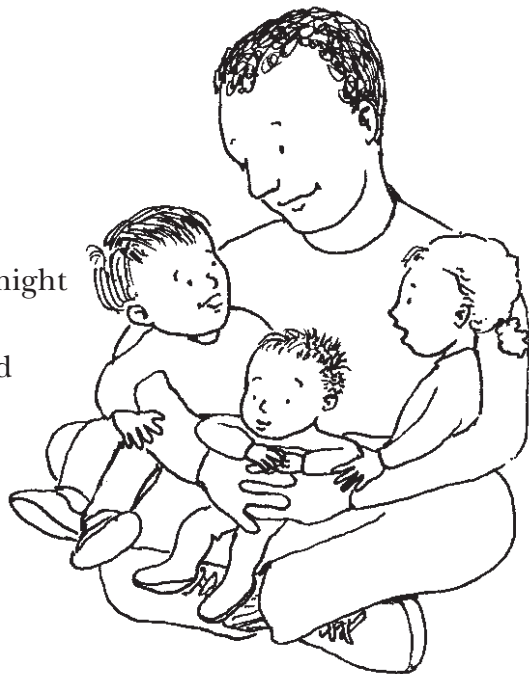

9 • We Can Move/ Hide and Seek

1–6 years



Try to get down to the eye level of the children; this can open or increase communication and interaction them. Let the children know what will be happening next.



What You Can Do

- Have two children hold hands to make a tunnel. Encourage your infants and young children to crawl through the tunnel. They could also be a tree, a mountain . . .
- Crouch down so you are face to face with the children; this encourages open or increased communication.
- Always smile and display a genuine interest in caring for the young child.



What To Look For

- Increased ability to recognize and analyze.
- Better sense of balance; children learn how to sit, kneel, crawl by using different body parts.
- Children have an opportunity to have fun with their caregivers; they gain self-confidence and basic trust.



Possible extension

- Select children to be leaders in other activities such as helper, to pass out, to collect materials, to greet guests, etc.



Caution

- Young children should always be under the supervision of responsible older caregivers.
- Ensure that children do not engage in dangerous activities and that they are not left alone.
- Never use physical or verbal punishment to correct your child's behavior.

10 • Follow the Leader

1-6 years



Children need to feel they are part of a team. Assigning roles is a way to increase the sense of responsibility, to build trust, and to organize interaction with children. Let the children know what will be happening next.



What You Can Do

- Choose one child to be a leader. The leader gets up and the other children follow him/her, imitating him/her as he/she moves around the room hopping, clapping hands, nodding head, waving, jumping, etc.
- Choose a new leader and the game continues.



What To Look For

- Children get a chance to express themselves.
- Children have an opportunity to lead other children in an activity.
- Children are given specific roles on a team and develop the feeling of being important.



Possible extension

- Select children to be leaders in other activities such as helper, to pass out, to collect materials, to greet guests, etc.



Caution

- Play this game over several days until every child has had a turn to be leader.
- Young children should always be under the supervision of responsible older caregivers.
- Ensure that children do not engage in dangerous activities and that they are not left alone.
- Never use physical or verbal punishment to correct your child's behavior.

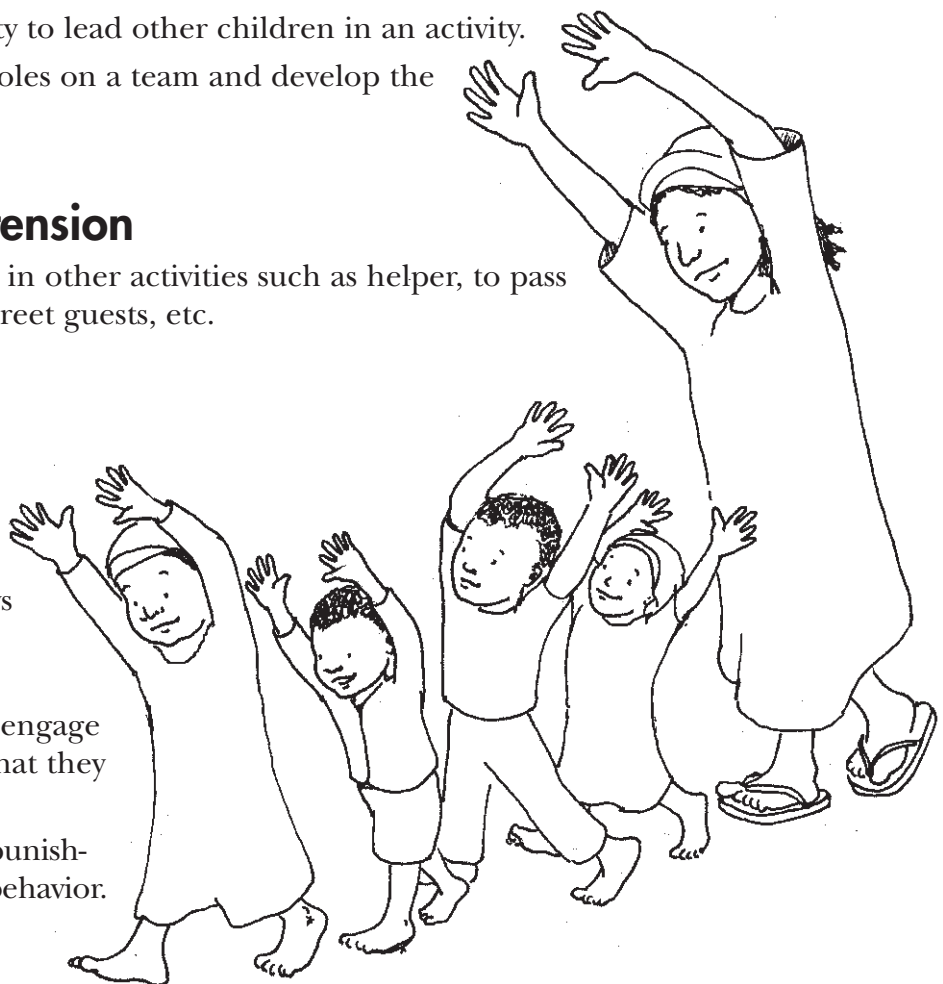

11 • Friends Together

1–6 years



Children need to see that they have friends so they are not left alone. Girls and boys get opportunities to share same activities together. Let the children know what will be happening next.



What You Can Do

- Ask children to choose a friend to be their partner. If the culture permits, encourage mixing (boys and girls together).
- Suggest that the children hold hands and take turns selecting and then doing a physical activity together, e.g., running, jumping, hopping, or walking backwards.



What To Look For

- Children feel secure with other children.
- Both girls and boys have friendly interactions with others.
- Children have an opportunity to make new friends.



Possible extension

- Ask the children to sit closely together in a circle so that their shoulders touch.
- Begin swaying back and forth to a song.
- Talk about how much fun it is to play together.



Caution

- Young children should always be under the supervision of responsible older caregivers.
- Ensure that children do not engage in dangerous activities and that they are not left alone.
- Never use physical or verbal punishment to correct your child's behavior.

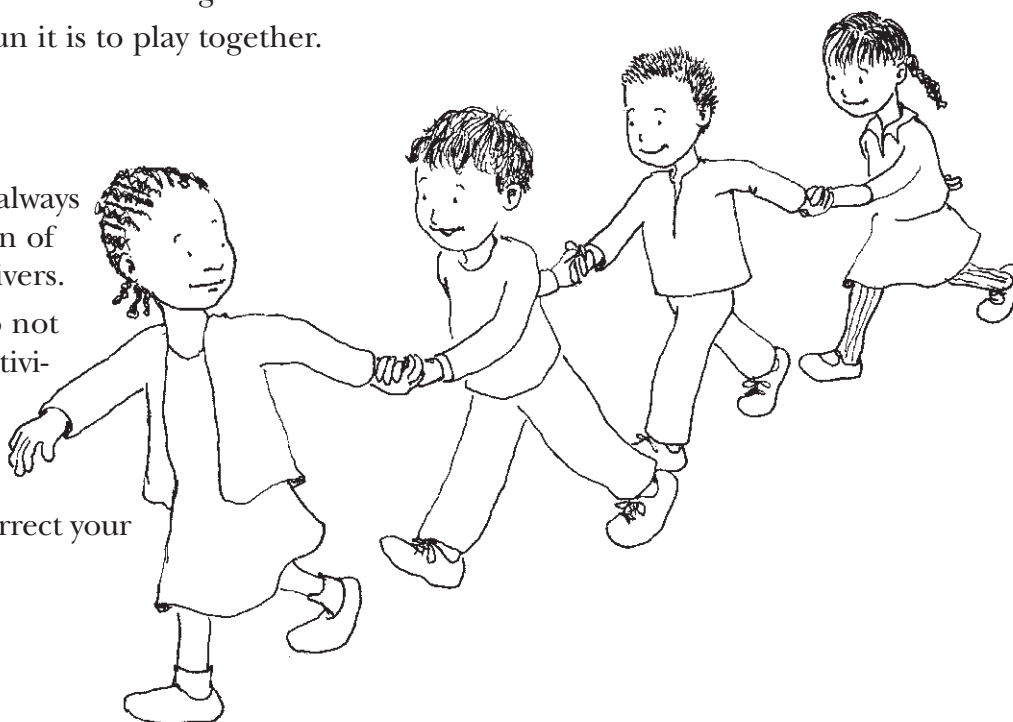

12 • One Toy, 1–6 years Two Children



Children need to see that they have friends so they are not left alone. Girls and boys get opportunities to share same activities together. Let the children know what will be happening next.



What You Can Do

- Tell the children a story about a quarrel between two children who hit each other because they both wanted the same toy. Ask children to help solve the problem of the quarrel. Ask questions: “What would you do if you were one of those children?”
- Two children are chosen to act out the situation of the quarrelling children.
- You and the other children encourage them to try to solve the problem through discussion to arrive at a mutual agreement.
- Encourage the children to applaud a positive solution to the quarrel.

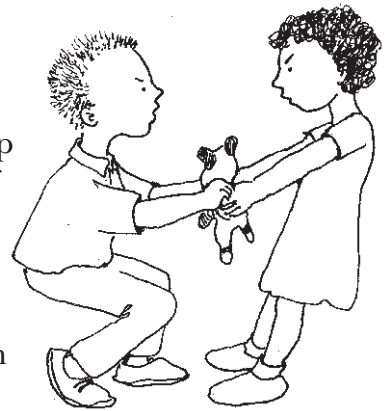

What To Look For

- Children know how to share and interact with others.
- Children feel important.
- Children have an opportunity to express themselves with others in an activity.

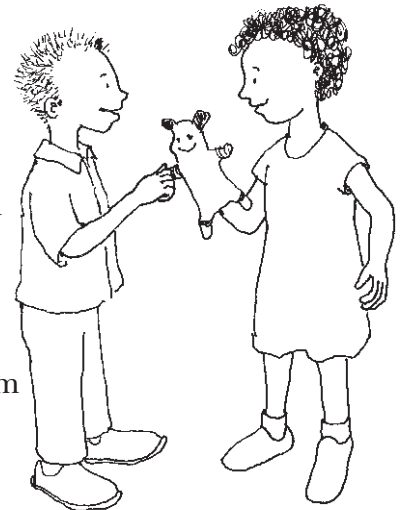

Possible extension

- Be alert to children’s disagreements in the group and encourage them to use problem-solving skills. Avoid solving their problems for them.
- Set up a mat where they can go to talk and play to resolve conflicts peacefully.
- Puppets or paper and crayons can be made available to help children express their feelings.
- Help children talk to each other the first time, and then they can go on their own. Instead of the adult intervening every time a conflict arises between children, the individuals involved can go to the “peace mat” to work it out on their own.



Caution

- Young children should always be under the supervision of responsible older caregivers.
- Ensure that children do not engage in dangerous activities and that they are not left alone.
- Never use physical or verbal punishment to correct a child’s behavior.

13 • Helping Partners

1-6 years



Children need to see that they have friends so they are not left alone. Girls and boys get opportunities to share same activities together. Let the children know what will be happening next.



What You Can Do

- Children form pairs and sit back-to-back with their arms interlocked with their partner. In this position they work together to stand up. Next, ask the children to face each other with their legs slightly bent and their feet touching. They hold hands and work together to stand up from this position.



What To Look For

- Children get a chance to express themselves.
- Children feel important.
- Children have an opportunity to lead other children in an activity.



Possible extension

- The same type of activity sometimes works with groups of three or four children.
- Talk with the children about the importance of working together.



Caution

- Young children should always be under the supervision of responsible older caregivers.
- Ensure that children do not engage in dangerous activities and that they are not left alone.
- Never use physical or verbal punishment to correct your child's behavior.

