

The International Space Station is made up of a series of modules, trusses, and panels. Can you number the pictured modules and panels to match this drawing of the Station?

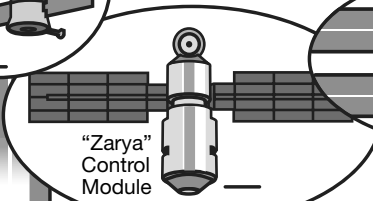

"Soyuz" Vehicle

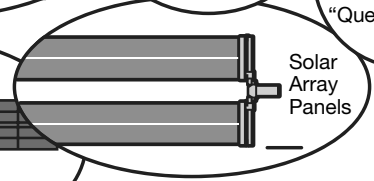
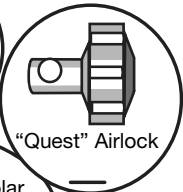
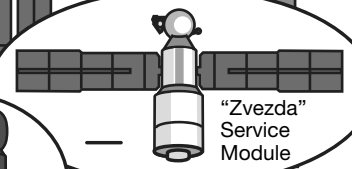

9

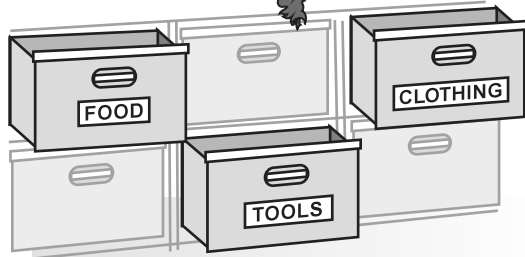
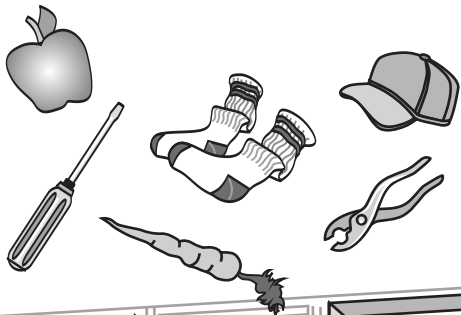

There is almost no gravity on the Station, so things float around if they're not restrained. Astronaut Mike needs to put these floating things back in the drawers where they belong. Can you help him? Draw lines from the objects to the place they belong.



There are many shelves, or "racks," on the Space Station. They can be used to hold experiments and research projects.

Astronaut Emily needs to find her way through all of the racks in the Destiny Lab so she can do research at the end of the maze. Can you show her how to get there?

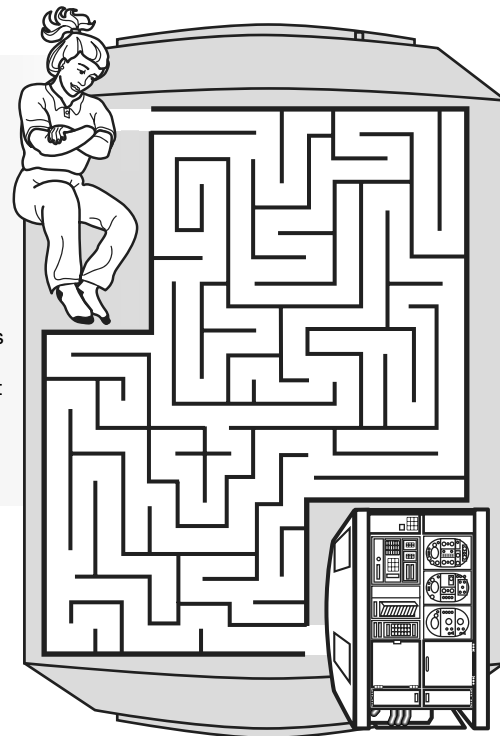

✦ The effort of building the Space Station involved more than 100,000 people located in 37 U.S. states and around the world.

✦ In about one day, the Space Station travels a distance equivalent to going to the moon and back.

✦ It circles the Earth every 90 minutes, so the crew sees the sun rise every 90 minutes.

✦ Docking to the Space Station is like driving a car backward at 200 miles per hour and trying to match tailpipes with a car facing the other way.

National Aeronautics and Space Administration

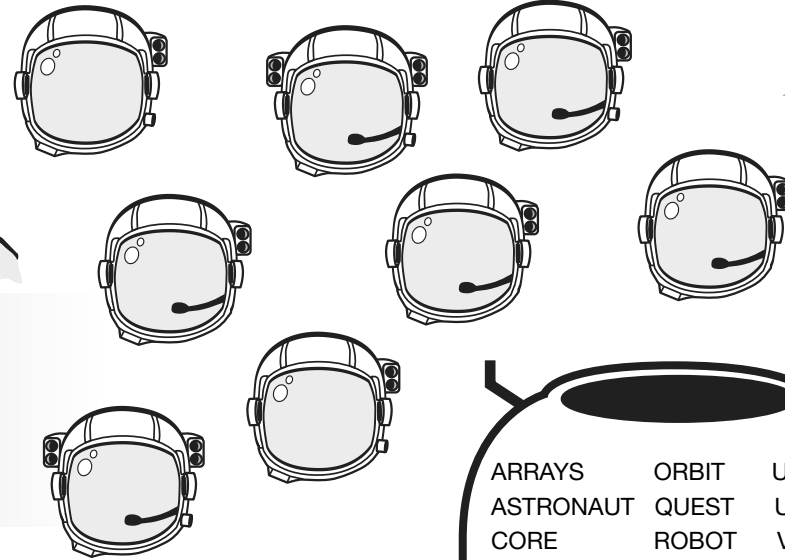
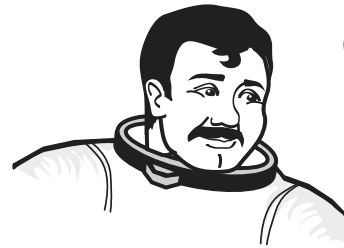

Connect the dots to draw a Soyuz rocket! This Russian rocket is one vehicle used to carry supplies, parts, and crew members to the International Space Station. An astronaut from Russia is called a "cosmonaut."

Astronaut Carlos must find his own space suit helmet so he can go on a spacewalk. He knows his helmet is unique. Can you find the helmet that isn't like any of the other helmets?

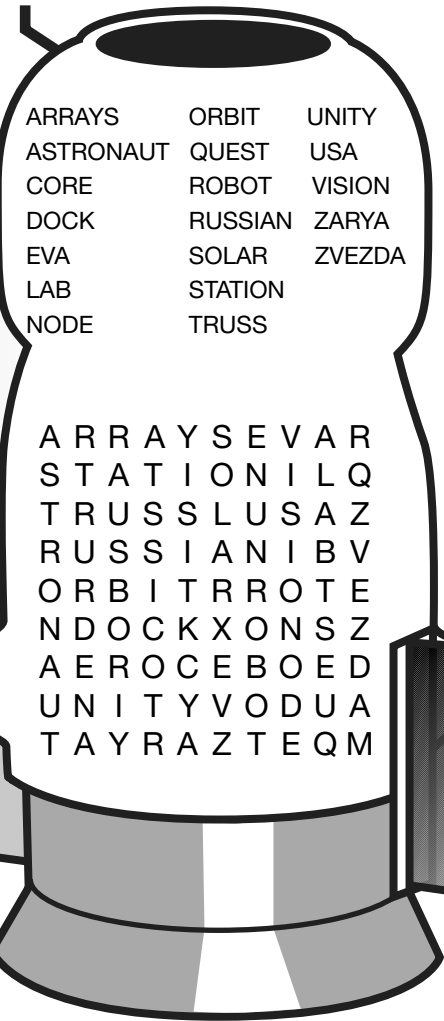

ARRAYS	ORBIT	UNITY
ASTRONAUT	QUEST	USA
CORE	ROBOT	VISION
DOCK	RUSSIAN	ZARYA
EVA	SOLAR	ZVEZDA
LAB	STATION	
NODE	TRUSS	

A R R A Y S E V A R
 S T A T I O N I L Q
 T R U S S L U S A Z
 R U S S I A N I B V
 O R B I T R R O T E
 N D O C K X O N S Z
 A E R O C E B O E D
 U N I T Y V O D U A
 T A Y R A Z T E Q M

This is a Soyuz vehicle from the International Space Station. Try to find the Station-related words in the puzzle.

The International Space Station is a home in space to astronauts and cosmonauts who are conducting scientific research to help improve life on Earth and give us the knowledge needed to step further into space. This research can be done nowhere else. Scientists are learning about:

- ✦ improved ways to make antibiotics and other medicines
- ✦ changes in Earth's climate, vegetation, and crops
- ✦ how the human body works
- ✦ better ways to recycle and purify water and air
- ✦ special ways to make things
- ✦ new ways to communicate
- ✦ the uniqueness of space

The International Space Station is huge! Its living space is larger than a five-bedroom house, and it weighs almost one million pounds - more than 330 cars put together!

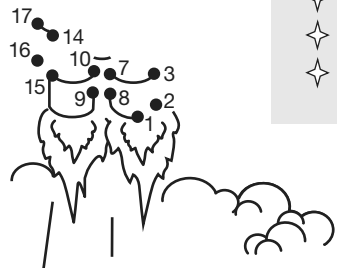
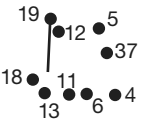
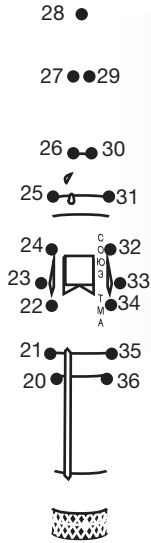



Orion Word Find

Recommended for Elementary School

- | | | |
|-----------|------------|---------------|
| ASTEROID | HUMAN | SOLAR SYSTEM |
| ASTRONAUT | MARS | SPACEFLIGHT |
| CAPSULE | NASA | TEAMWORK |
| CREW | ORION | TEST |
| EXPLORE | PARACHUTES | UNITED STATES |
| ENGINEER | SAFETY | VEHICLE |
| FUTURE | SCIENTIST | |

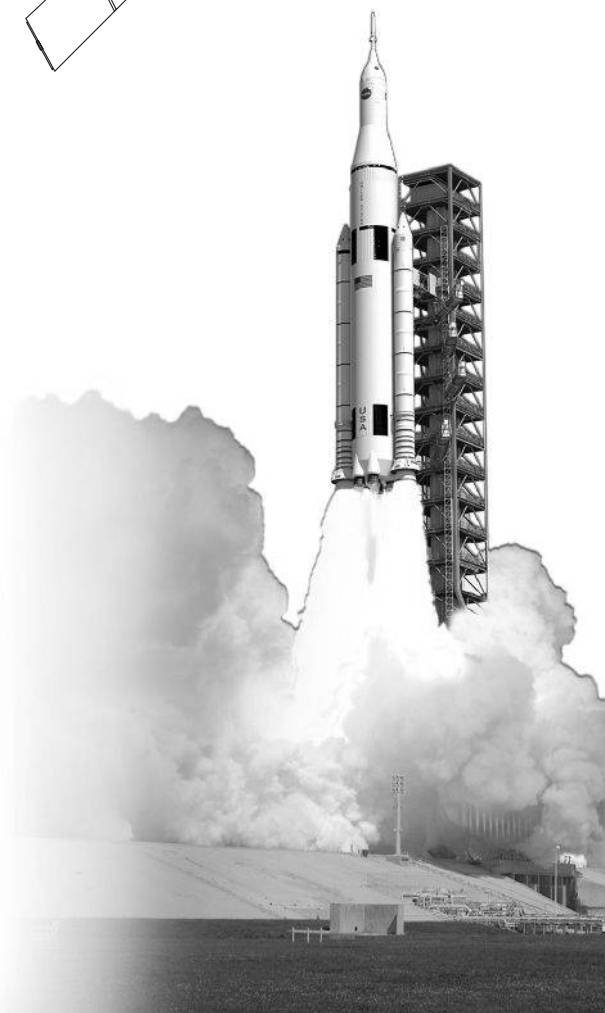
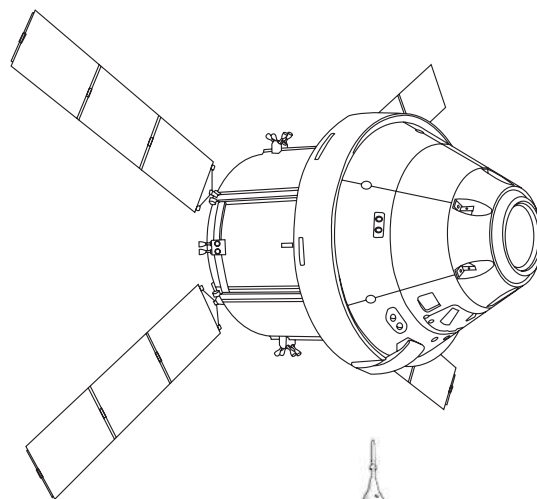

A M S T A U T U A N O R T S A
S E A H U N T E R N M D B O D
T N F U T U R E Z M U E E L F
E G E H J U M X N K N L K A L
R I T D O W N P O B I C K R T
O N Y N U N R L I N T I C S K
I E E D A R O O R N E H O Y R
D E M M A S T R O I D E J S O
K R U M S C A E F X S V H T W
O H S C I E N T I S T O O E M
A R S M T I M E G M A R S M A
S P A C E F L I G H T W O O E
A C E W Y U P Q A W E T S E T
C A P S U L E P S R S P C F E
A S T R P A R A C H U T E S M



Orion Word Find

Recommended for Middle School and above

- | | | | |
|-------------|--------------|--------------|----------------|
| ASTEROID | FUTURE | ORION | SPACEFLIGHT |
| ASTRONAUT | HUMAN | PARACHUTES | STRATEGIC |
| AVIONICS | LANDING | PAYLOAD | TEAMWORK |
| BEYOND | LAUNCH | PROGRAM | TECHNOLOGY |
| CAPSULE | MARS | RELIABLE | TEST |
| CHALLENGE | MASS | RESEARCH | TRANSPORTATION |
| CREW | MISSION | SAFETY | UNITED STATES |
| ENGINEER | MULTIPURPOSE | SCIENCE | VEHICLE |
| EXPLORATION | NASA | SCIENTIST | VIBRATION |
| EXPLORERS | ORBIT | SOLAR SYSTEM | |

T A T R A V E M O O L C R R E S E A R C H S S E E
H U R U V E H I C L E S A M N O N T I V I H O R S
G R A N U L E A M A R S M U L T G O W A F C L S R
I U N E I K F U T U R E F U T I I B W Q U N A P E
L O S M E G H I D N X P L O R B N T A O X U R A R
F C P A U D N L W C O S X C K R E C N E I A S C O
E H O E X L P O F H C A P S U L E Y D R U L Y E L
C A R L M O T D A I Y O T H S N R C O S T S S F P
A L T R B O T I N A H O P K L F U T R N O A T L X
P L A M C O T O P H S T R A T E G I C A D S E I E
S E T S E T I U V U E E X P L O R A T I O N M G R
O N I E P V O A B M R K T Z A O R E E R T D O H W
P G O N A S A Q T A N P R O R E Z C S S A F E T Y
B E N G Y U Y H P N W S O M X P A R T I P H G J K
L A T S L A N D I N G B N S C I E N T I S T O Y S
P R O R O M P A R A C H U T E S P U D T H E G R A
B O T M A S S T E R N F L E W P A U I P X C R E W
M D O I D T O Y L O S M R V I N C E O A Z H O K N
A G O S U T T O I L I K E B O O E W R R N N R O S
R E R S T O R T A O R I O R N R U X E I S O P O C
G A F I N D A W B A S T T I O B V O T N W L O M I
O R I O P R O N L W G S K Z O I T X S M K O R Y E
R I O N B L W S E S A B M X O T N M A F R G R U N
P R O I V O R I O N U N I D S R E E M T A Y A R C
M O V R C R E X P U N I T E D S T A T E S S H A E



Resources for students and educators of grades K-12

NASA Home Page
www.nasa.gov

NASA Johnson Space Center
www.nasa.gov/johnson

NASA Orion Spacecraft
www.nasa.gov/orion

“What is Orion?” Education Page
<http://www.nasa.gov/audience/forstudents>

NASA Space Launch System
www.nasa.gov/sls

NASA Ground Systems
<http://www.nasa.gov/exploration/systems/ground>

NASA’s “Beyond Earth”
www.nasa.gov/exploration/home

NASA’s Education Home Page
<http://www.nasa.gov/offices/education/about>

NASA Educator Resource Network
<http://www.nasa.gov/offices/education/programs>

Mars Funzone:
<http://mars.jpl.nasa.gov/participate/funzone>

Space Place:
<http://spaceplace.nasa.gov>

National Aeronautics and
Space Administration



Let's Explore With

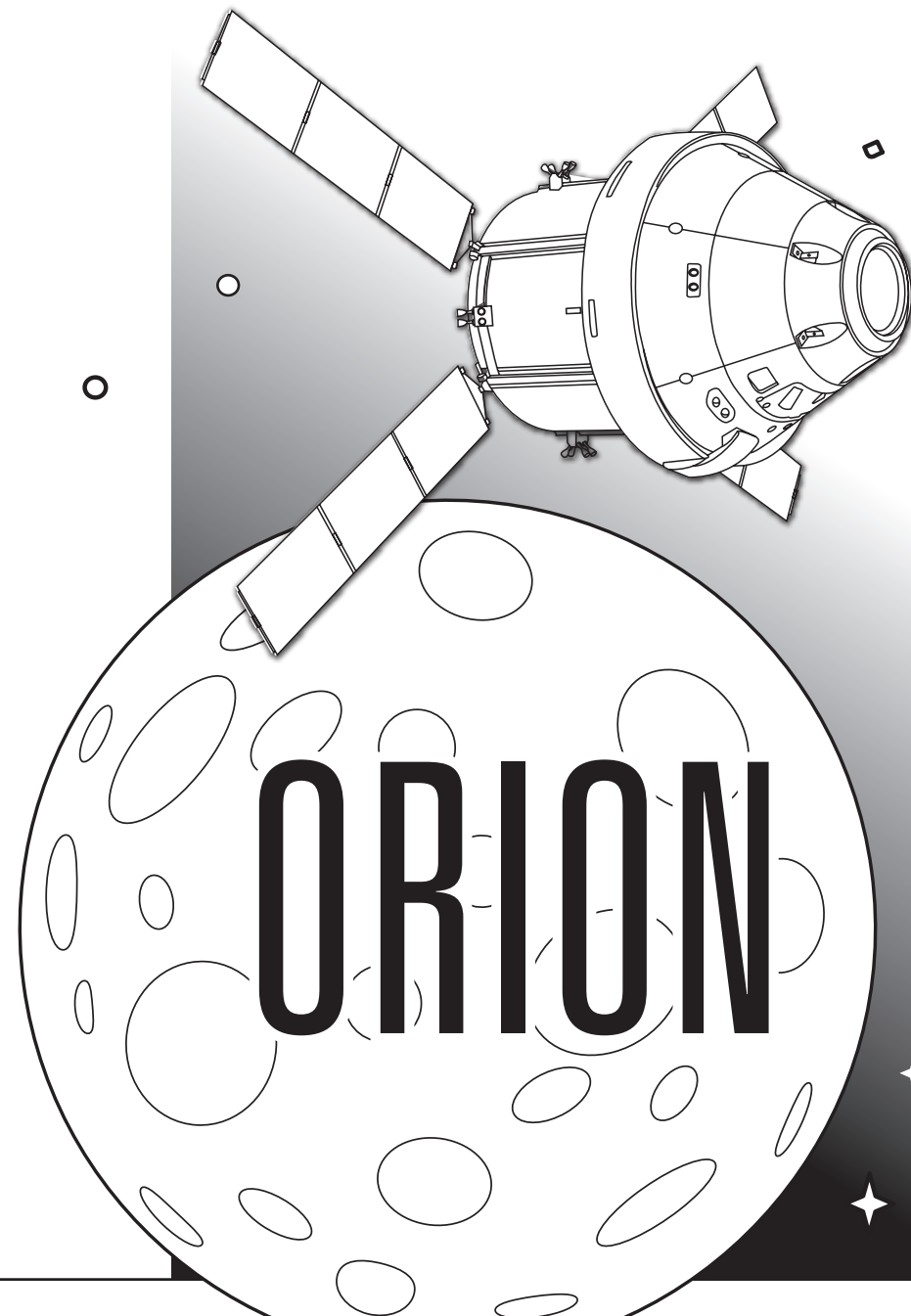

Deep Space Destination: Asteroids

Help Orion reach the near-Earth asteroid and begin the Asteroid Redirect Mission

Asteroids are more than just floating rocks in space, they are leftover building blocks from the formation of our solar system and hold clues to the chemical makeup of nearby planets. NASA's Asteroid Initiative wants to learn the secrets of our solar system's history and has created a three-part plan called the Asteroid Redirect Mission (ARM). ARM will allow astronauts to take samples of a nearby asteroid and bring them back to Earth for analysis. Scientists are currently working to find the best asteroid candidate for this mission. Once selected, a robotic mission will redirect the asteroid into a stable orbit above the moon. Astronauts will then climb aboard the Orion spacecraft and be launched into space where they will perform two spacewalks to collect asteroid samples. ARM's early use of the Orion spacecraft will help lay the foundation for its crewed mission to Mars.

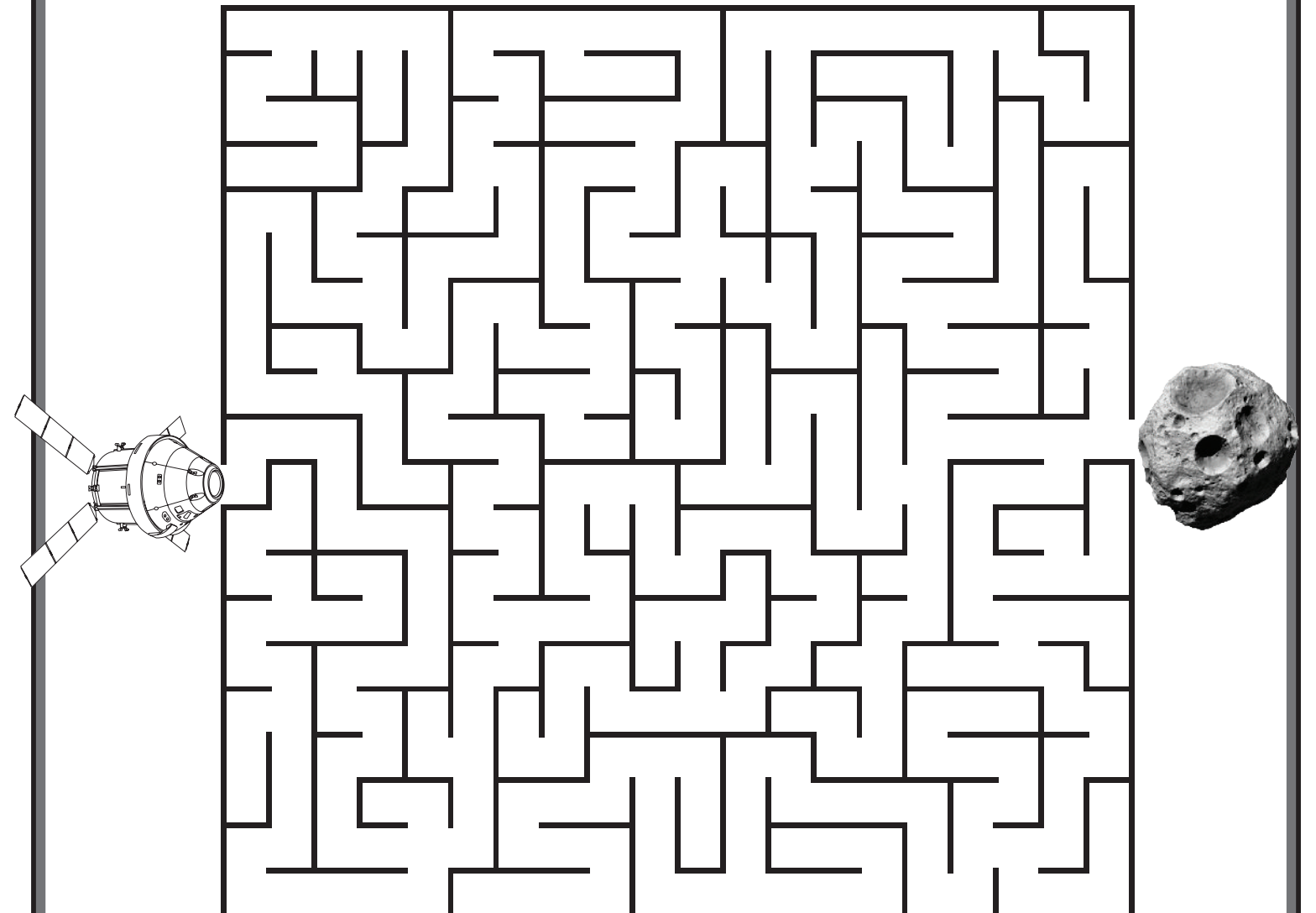

*Answers on back page.

Fuel Up and Fly!

At Kennedy Space Center's launch site, Orion and the Space Launch System (SLS) are ready to blast off. Help the ground operations crew fill up for launch.

Fuel Fact: Hydrogen can be found in large amounts in gas giant planets and stars.

Fuel Fact: Although oxygen gas is colorless, the liquid and solid forms of oxygen are blue.

The SLS rocket holds 520,456 gallons of liquid hydrogen and 194,443 gallons of liquid oxygen. There are three tanks at the launch pad that hold 300,000 gallons of fuel each. Once the rocket is completely fueled, how much liquid hydrogen and oxygen will be left in each ground tank? Fill in the blanks. *Hint: You will need to totally empty one hydrogen tank before using the other.*

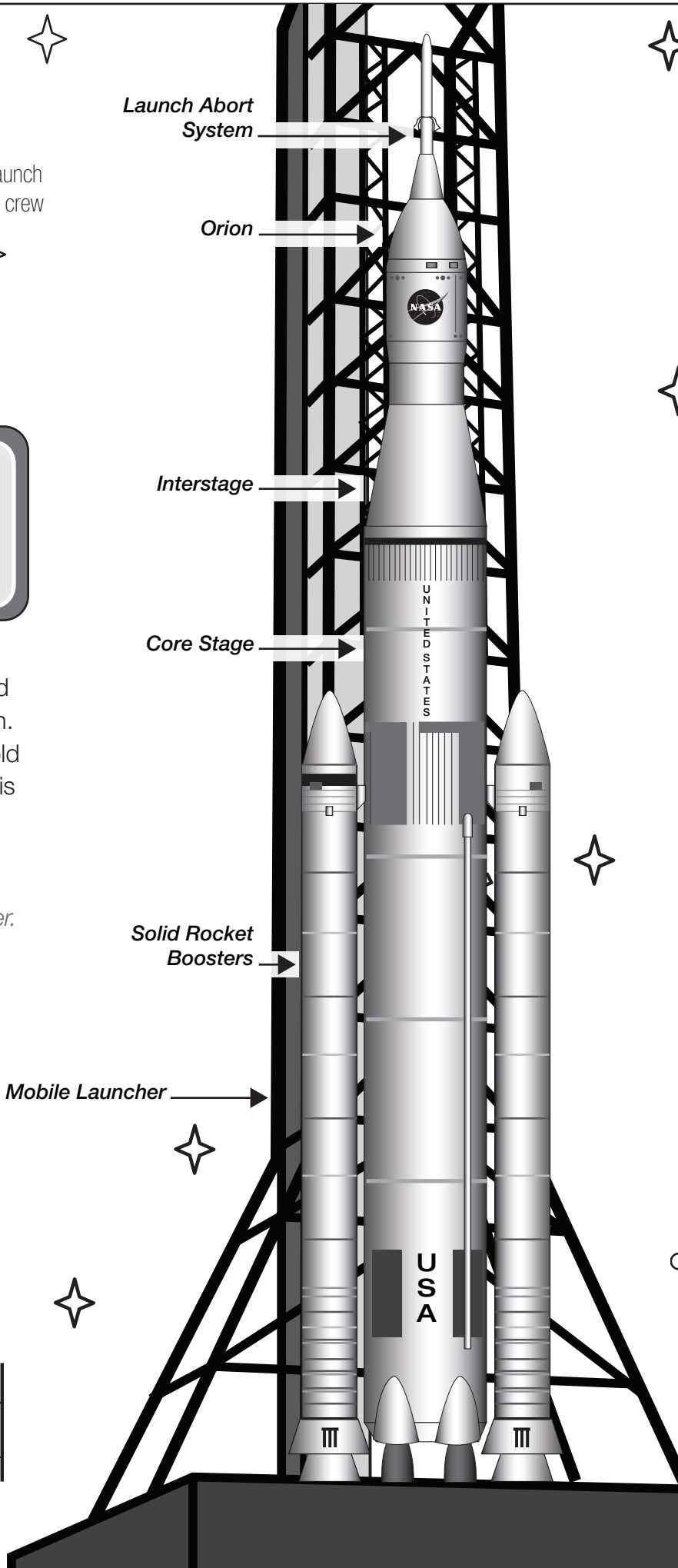
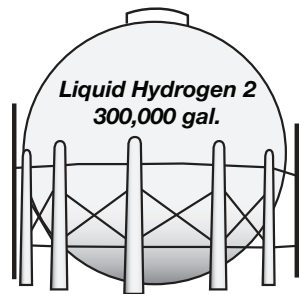
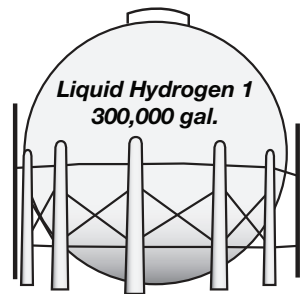
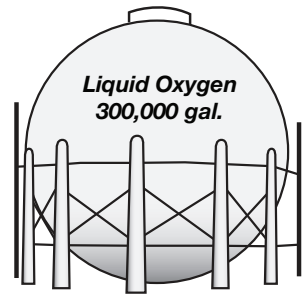

Learn about Orion and the Space Launch System (SLS)

Fill in the blanks to learn about the Orion Spacecraft.

Word Bank

- Earth
- Exploration Mission-1
- four
- 321
- 69,000
- 4,000°F
- moon
- constellations
- 2,000°F
- 20,000 mph
- 154,000
- low-Earth orbit
- Mars
- Asteroid

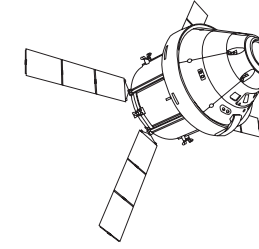

1. This new spacecraft will allow us to go farther than we've gone before, including to _____.
2. Orion is named after one of the largest _____ in the night sky.
3. Orion is being rigorously tested as engineers prepare it for a journey beyond _____.
4. The first SLS mission is called _____.
5. Orion's heat shield can withstand temperatures of approximately _____.
6. The SLS will stand _____ feet tall and will carry _____ pounds of payload.

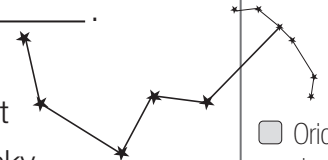

Learn About Orion/SLS answer key

1. Mars
 2. constellations
 3. low-Earth orbit
 4. Exploration Mission-1
 Liquid Oxygen Tank: 105,557
 Liquid Hydrogen Tank 1: 0
 Liquid Hydrogen Tank 2: 79,544

5. 4,000°F
 6. 321 and 154,000

*** Answers**

Orion and SLS Fun Facts...

- The heat shield will have to withstand temperatures of approximately 4,000°F during the Earth re-entry phase of Orion's first spaceflight, Exploration Flight Test-1. Just how hot is 4,000°F?
 - About twice the temperature of Hawaiian basaltic lava, which reaches 2,120°F
 - About the same as the Earth's molten core or a nuclear reactor meltdown, which are both about 4,000°F
- Orion will make use of advances in propulsion, communications, life support, structural design, navigation and power, drawing from the extensive spaceflight experience of NASA and its industry partners.
- The first Orion test flight will occur this year. The spacecraft will launch 3,600 miles into space in order to reach speeds of more than 20,000 mph.
 - 3,600 miles is also more than 15 times farther than the International Space Station's orbital position. The United States is approximately 3,000 miles wide, so Orion will travel farther up than the distance across the entire country!
- Orion will have the capability to carry humans to multiple destinations beyond low-Earth orbit, including, Mars!
- The SLS height is 321 feet, which is taller than the Statue of Liberty.
- The SLS will use proven hardware and cutting-edge tools and manufacturing technology from the Space Shuttle Program.
- The SLS will stand atop a modified mobile launcher and will launch from the same pad as the Saturn V and space shuttles.

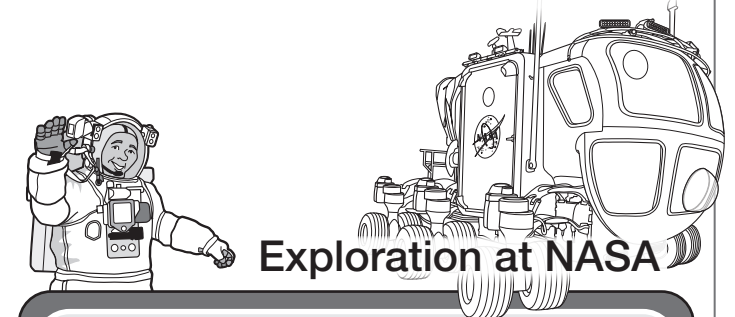

Exploration at NASA

This is the beginning of a new era in space exploration. We are building the capabilities to send humans beyond low-Earth orbit and to destinations such as Mars. Orion and SLS are at the core of NASA's human exploration plans. Other technologies include new spacesuits, advanced communications systems, advanced propulsion methods and more! The road ahead is challenging but this approach to space exploration puts us in a position to go where no human has gone before. To learn more about NASA's exploration missions, please visit: www.nasa.gov/exploration.