

NASA's New Spacecraft: Orion

The Orion spacecraft will launch aboard the Space Launch System (SLS). Together they will serve as our nation's next generation exploration vehicles transporting transport humans to asteroids, the moon, Lagrange points — and ultimately to Mars.

Drawing from more than 50 years of spaceflight research and experience, Orion features dozens of technology innovations and advancements such as unique life support, propulsion, thermal protection and avionics systems. These advanced systems will support long-duration deep space missions, and bring future crews home safely.

The spacecraft includes a crew module, a service module, a spacecraft connector, and a launch abort system which ensures the safety of the crew during an emergency on the launch pad or during ascent. The crew module can support up to four astronauts for short or long-duration spaceflight missions. The service module is the powerhouse that fuels and propels the spacecraft. It also stores the life-sustaining air and water that astronauts need during space travel. Additionally, the service module's structure will provide areas to mount scientific experiments and cargo.

The Orion and SLS will take astronauts farther into the solar system than ever before, continuing America's journey of discovery.

To learn more about human spaceflight at NASA visit: www.nasa.gov/exploration

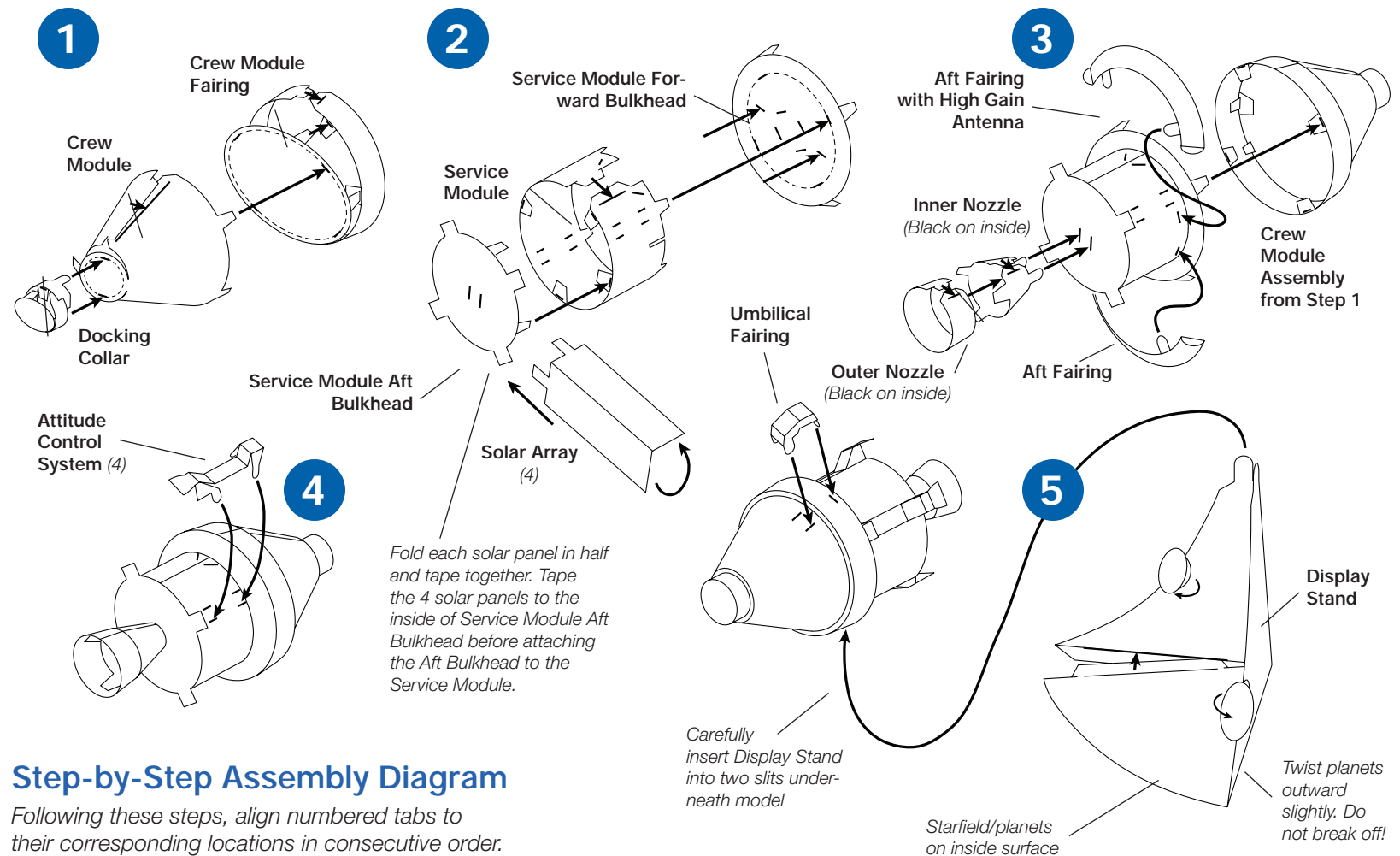
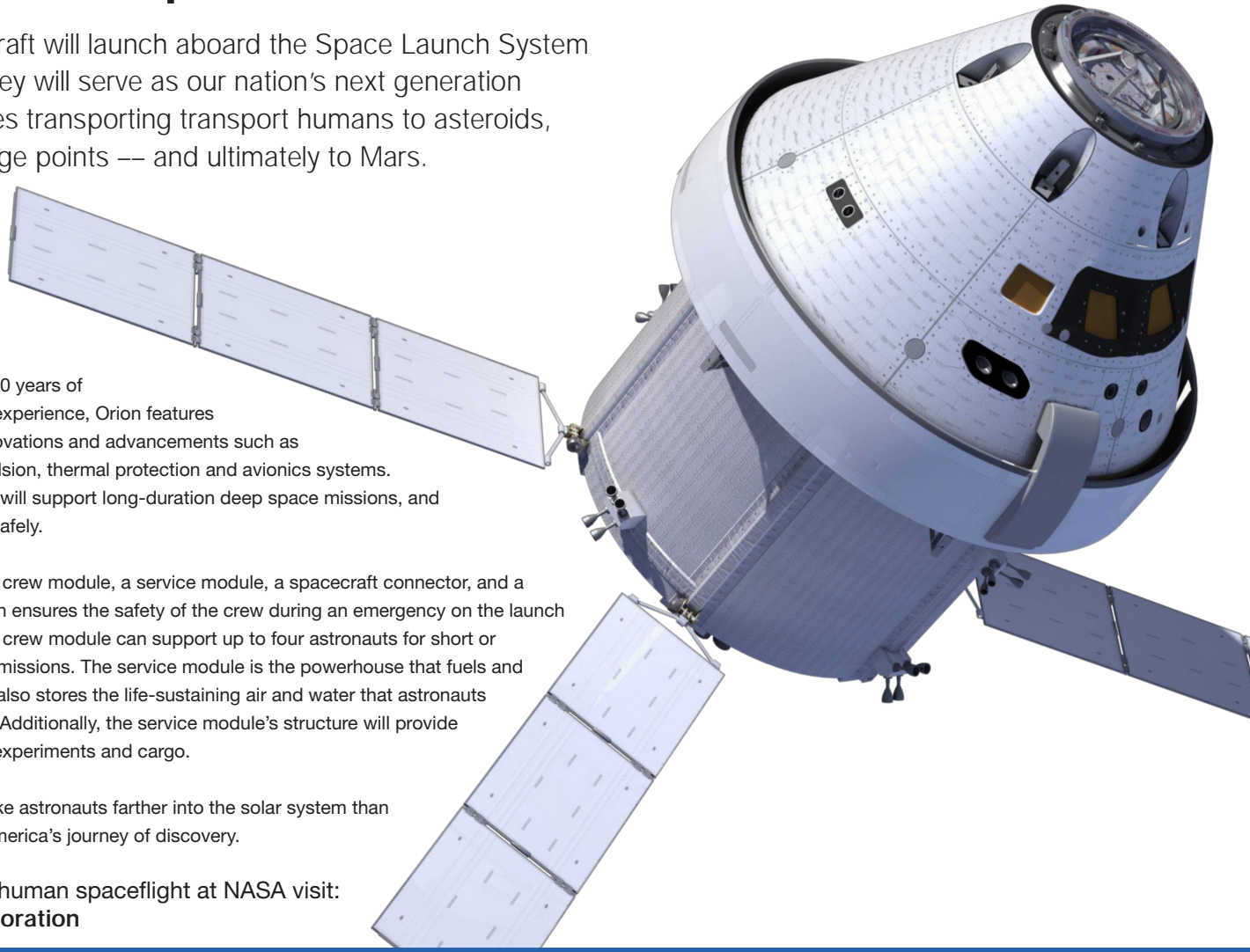

Step-by-Step Assembly Diagram

Following these steps, align numbered tabs to their corresponding locations in consecutive order.

Service Module
Aft Bulkhead

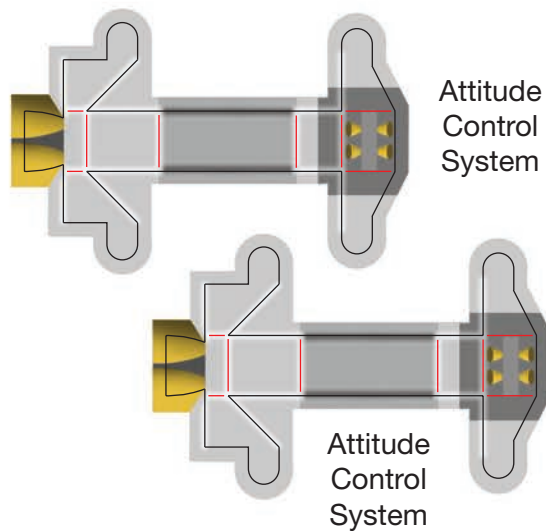
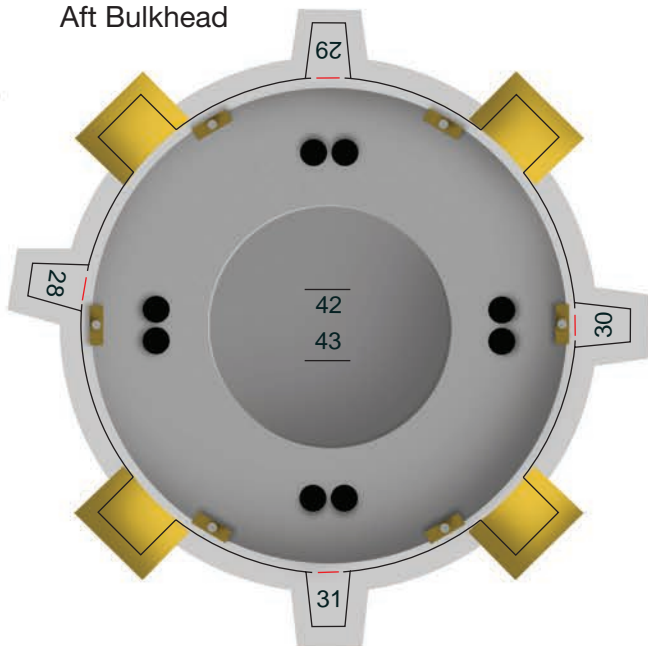

Attitude
Control
System

Attitude
Control
System

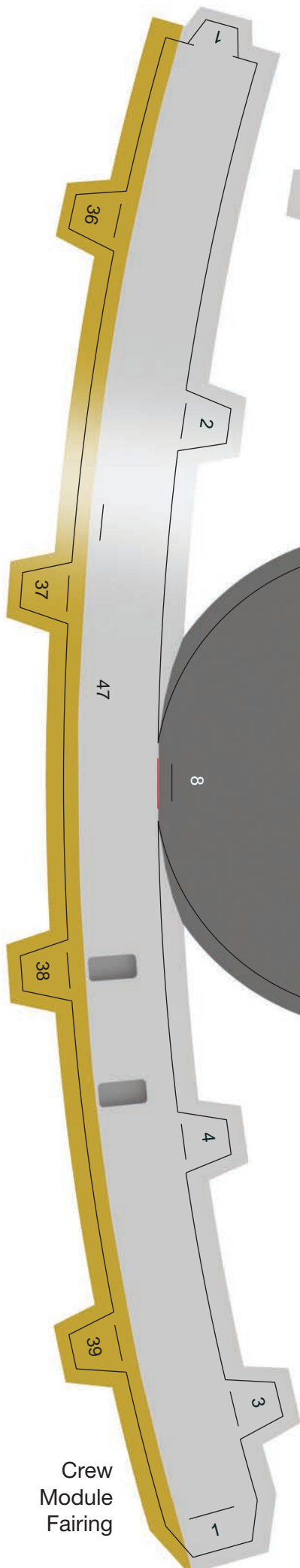

Crew
Module
Fairing

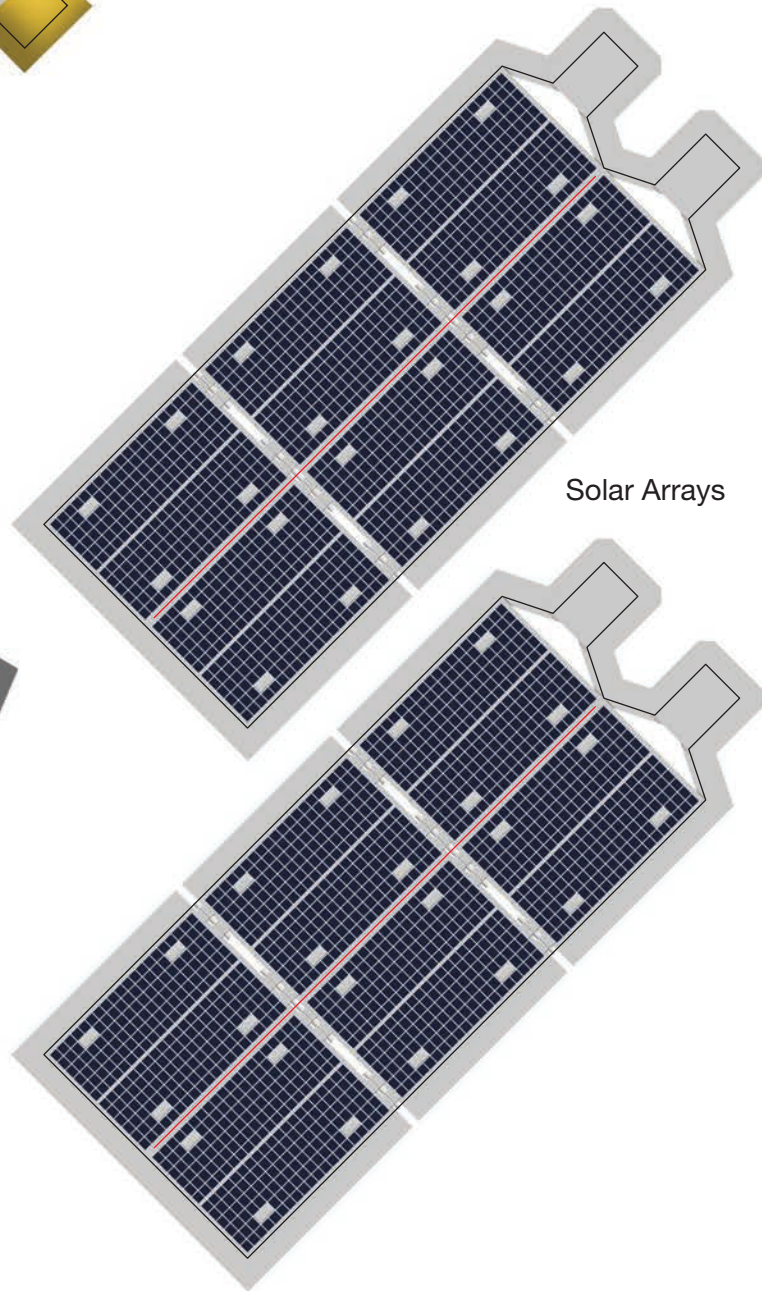
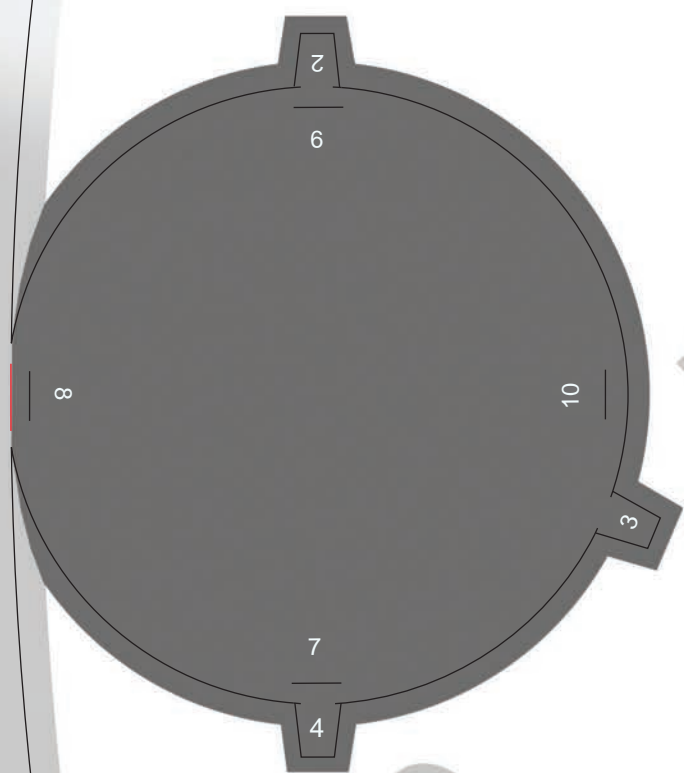

Solar Arrays



Aft Fairing

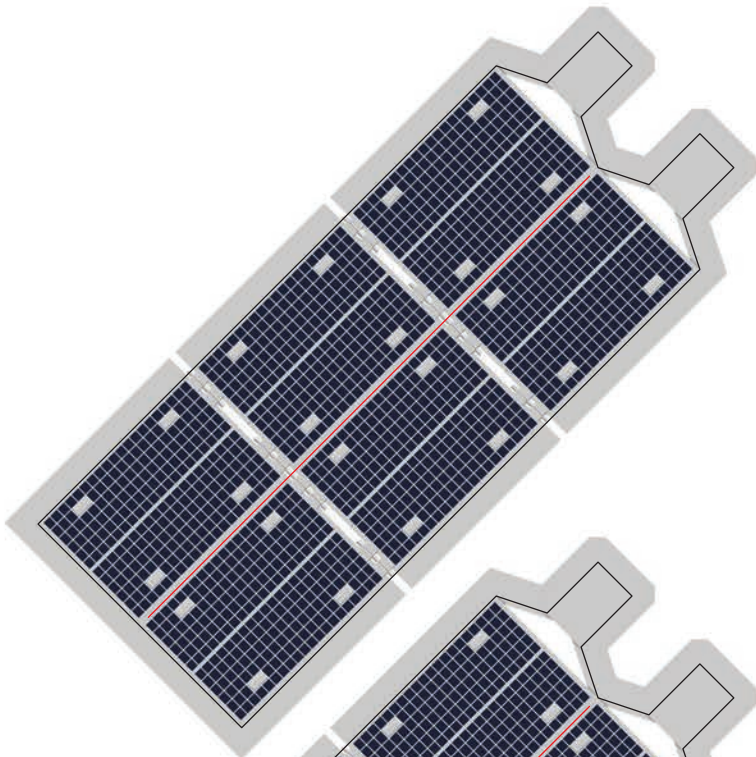

Solar Arrays

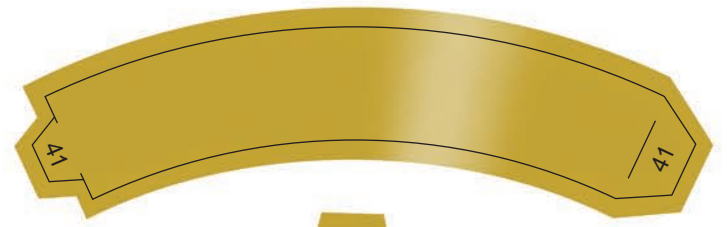
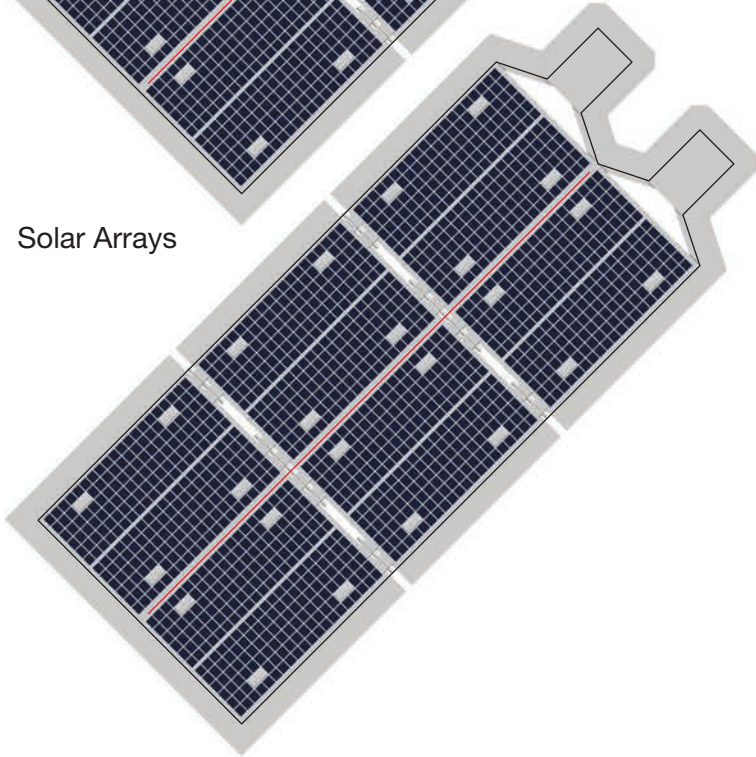

Outer Nozzle

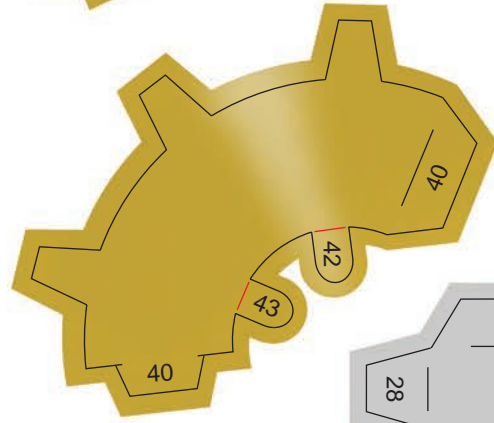

Inner Nozzle



Aft Fairing

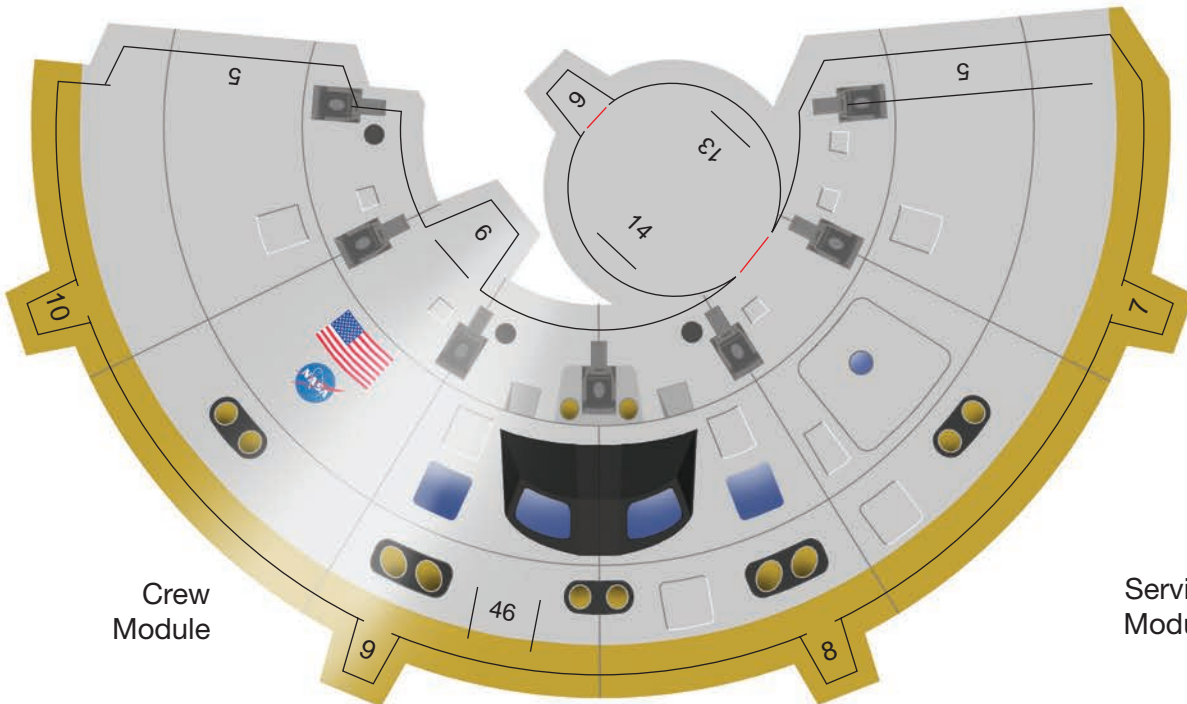

Crew Module

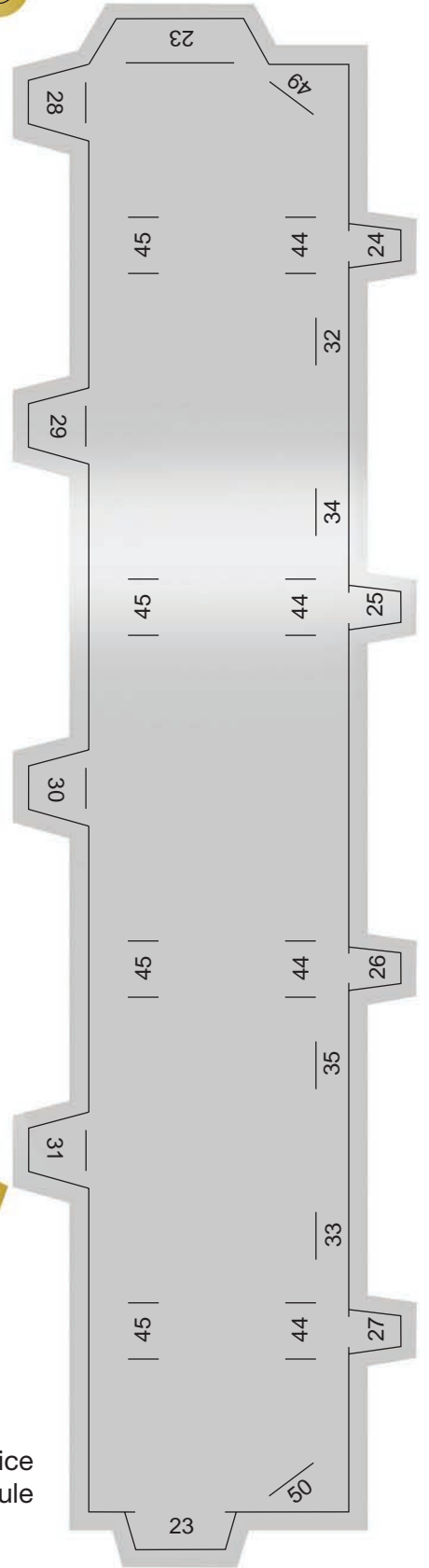

Service Module

Attitude Control System

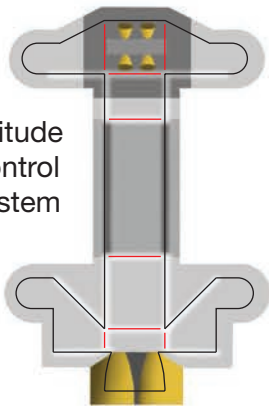

Docking Collar

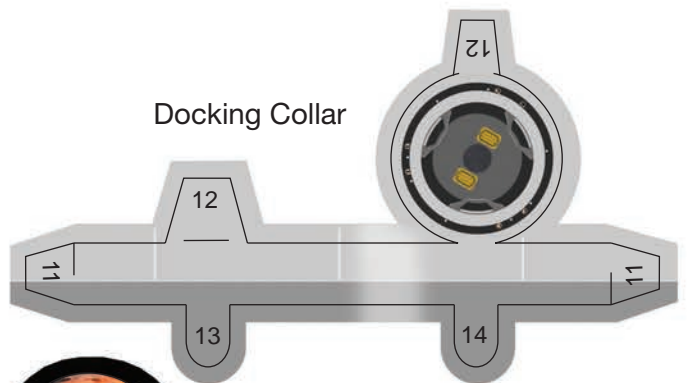

Umbilical Fairing

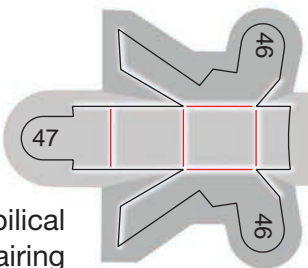

Service Module Forward Bulkhead

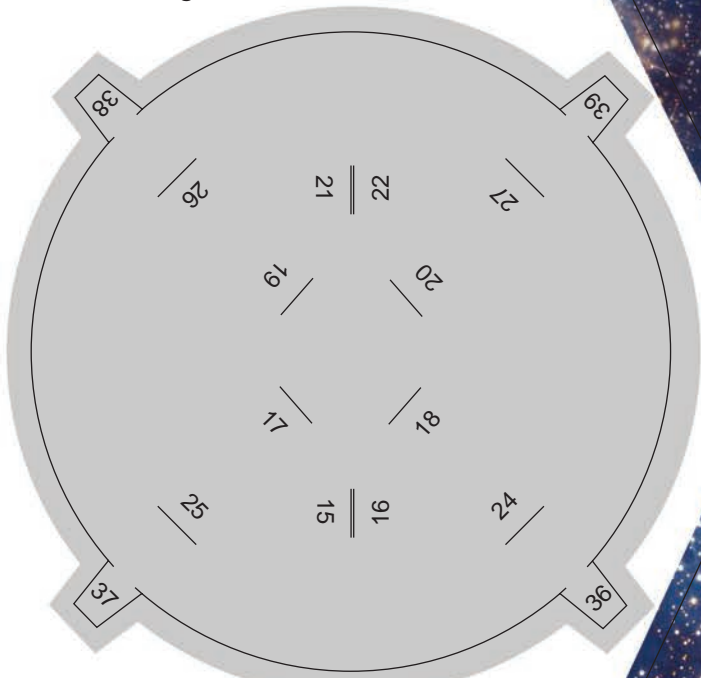

Attitude Control System

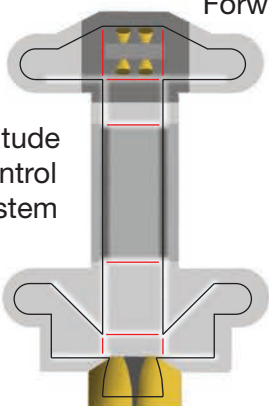

Display Stand



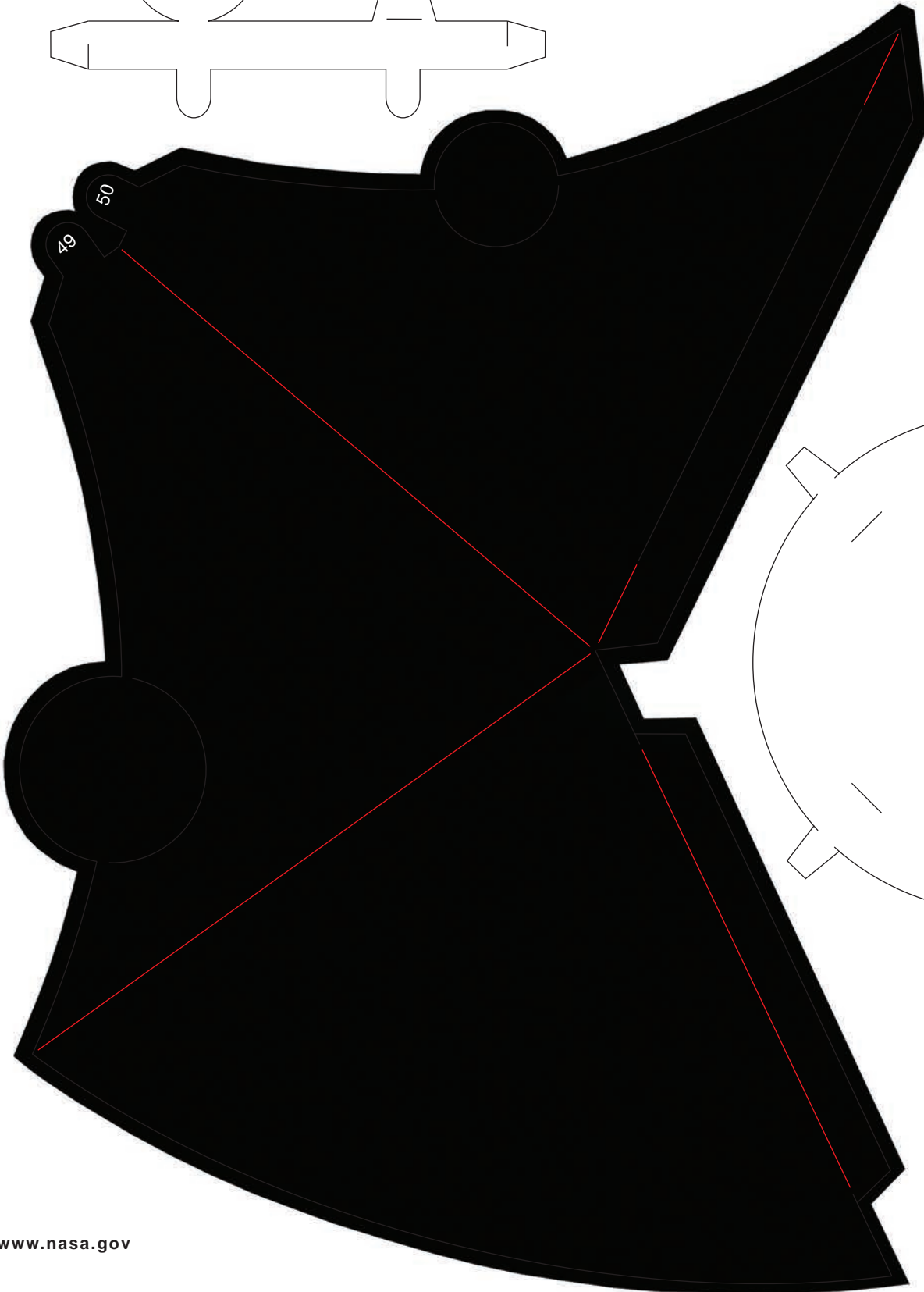
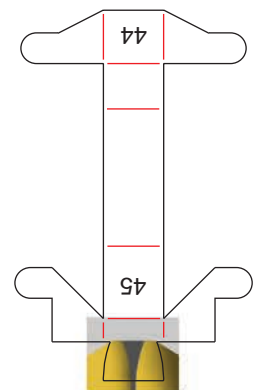
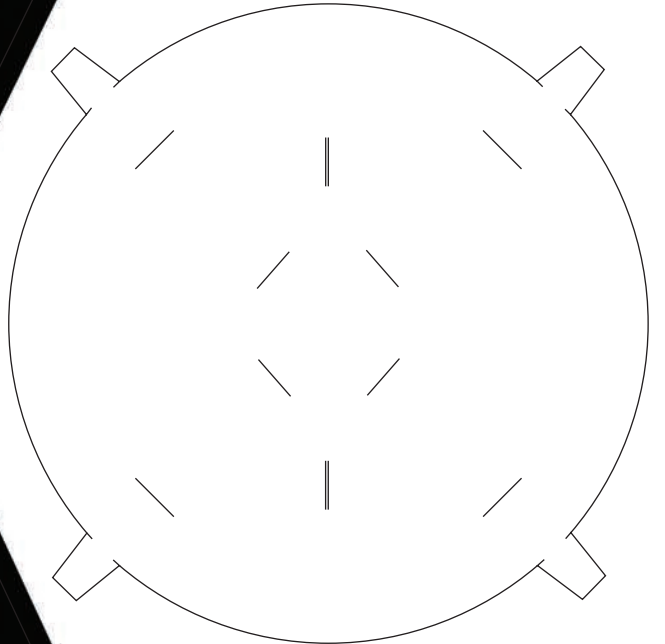
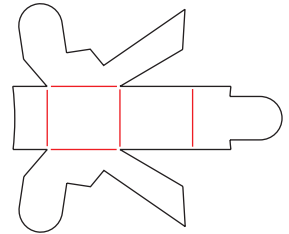
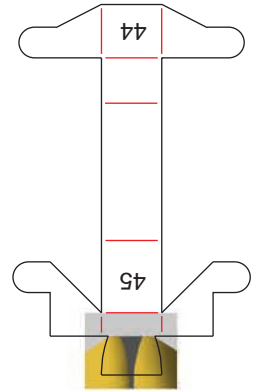
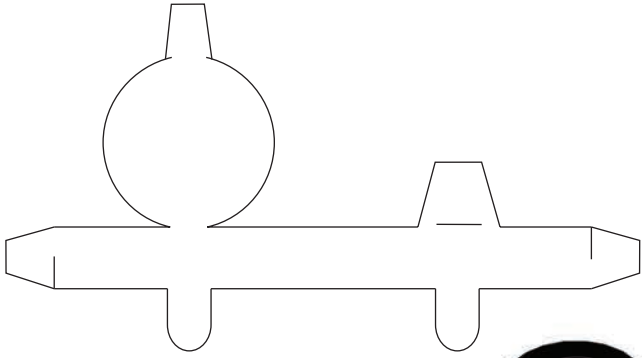

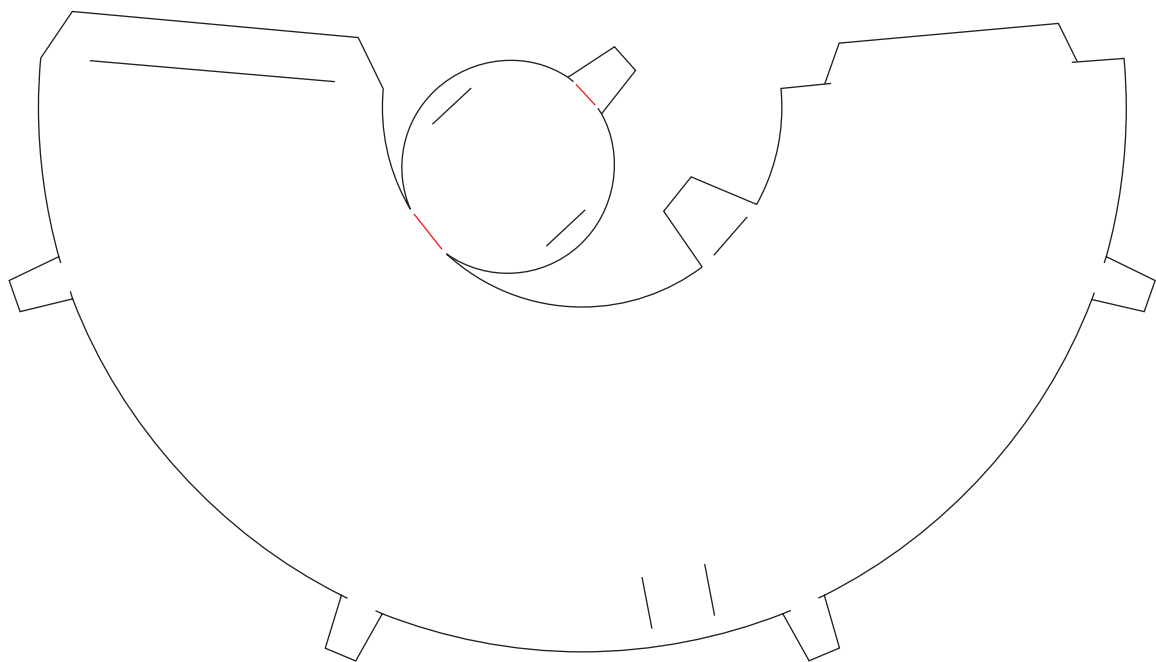
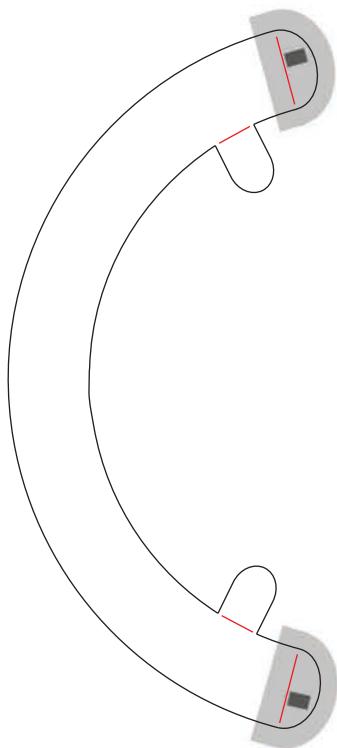
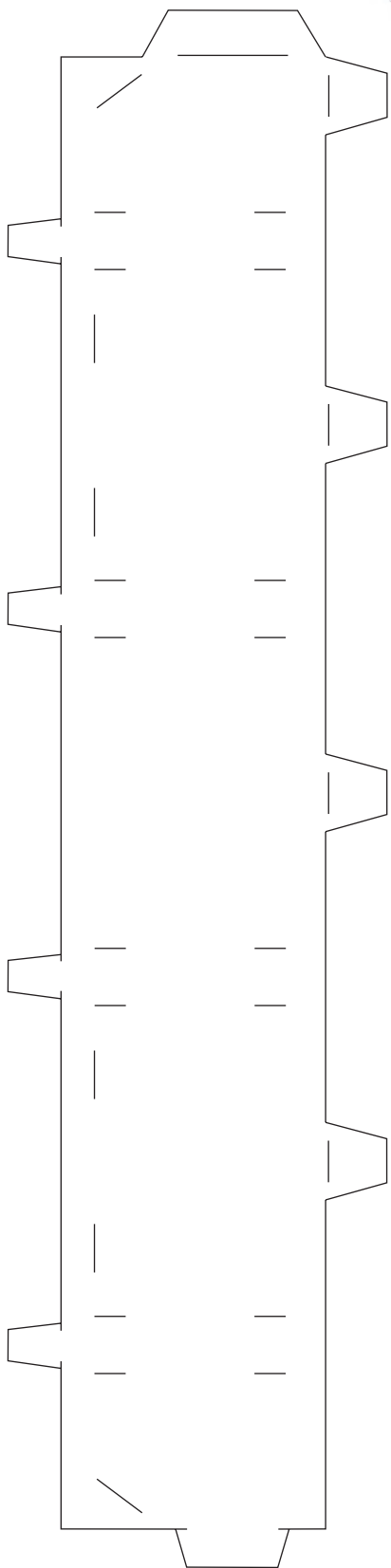
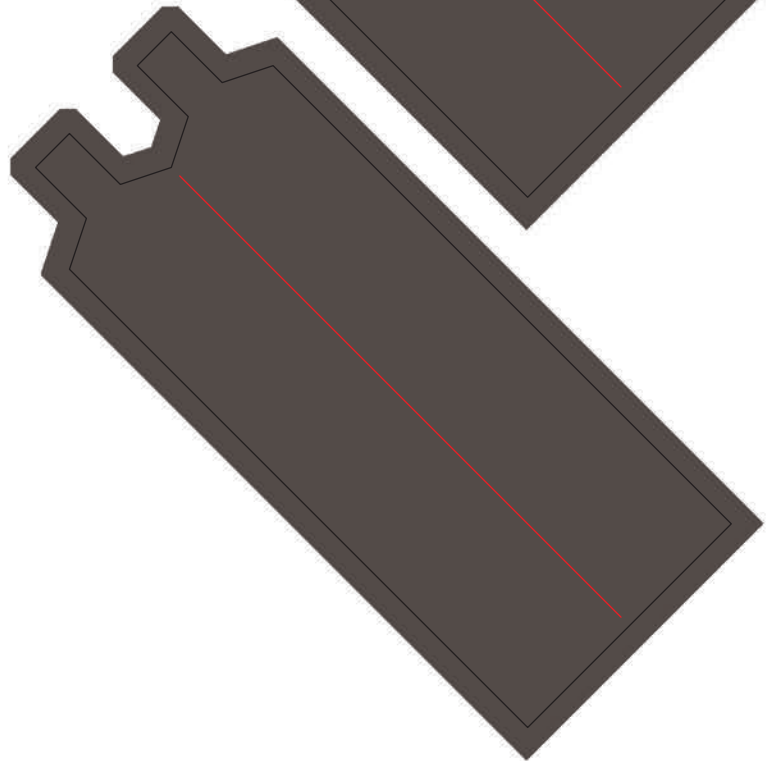
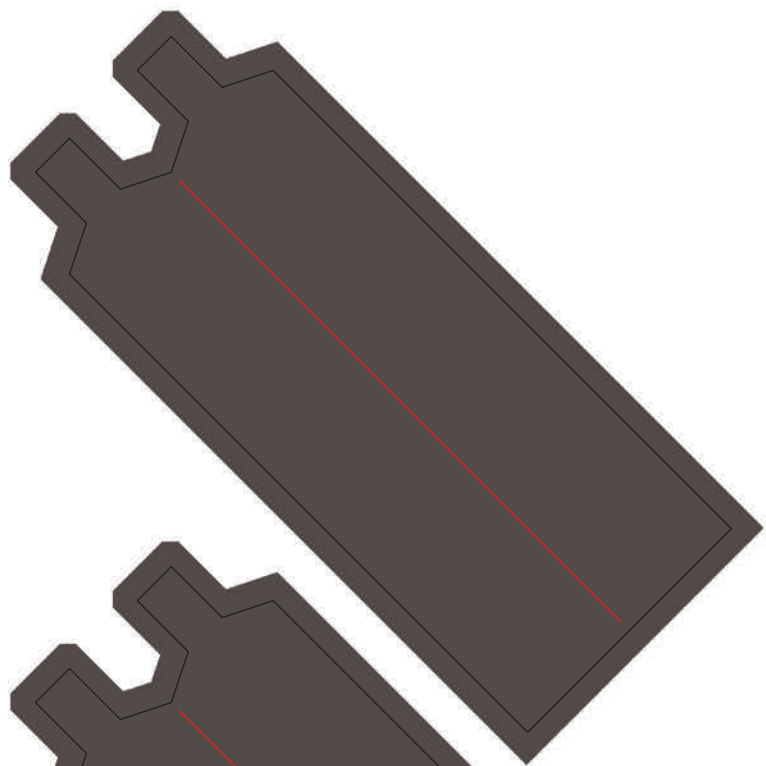
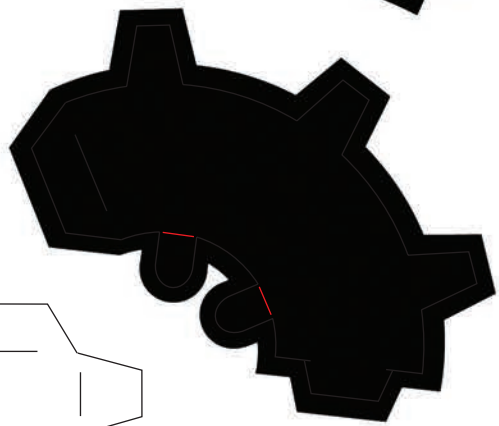

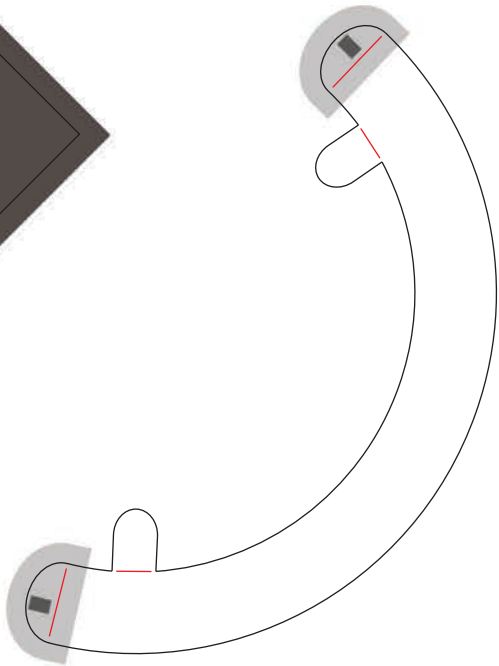
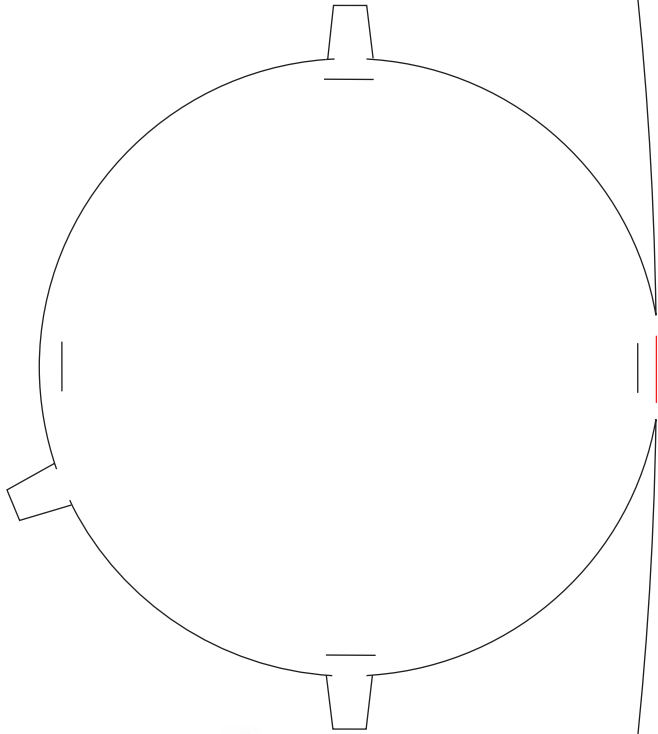
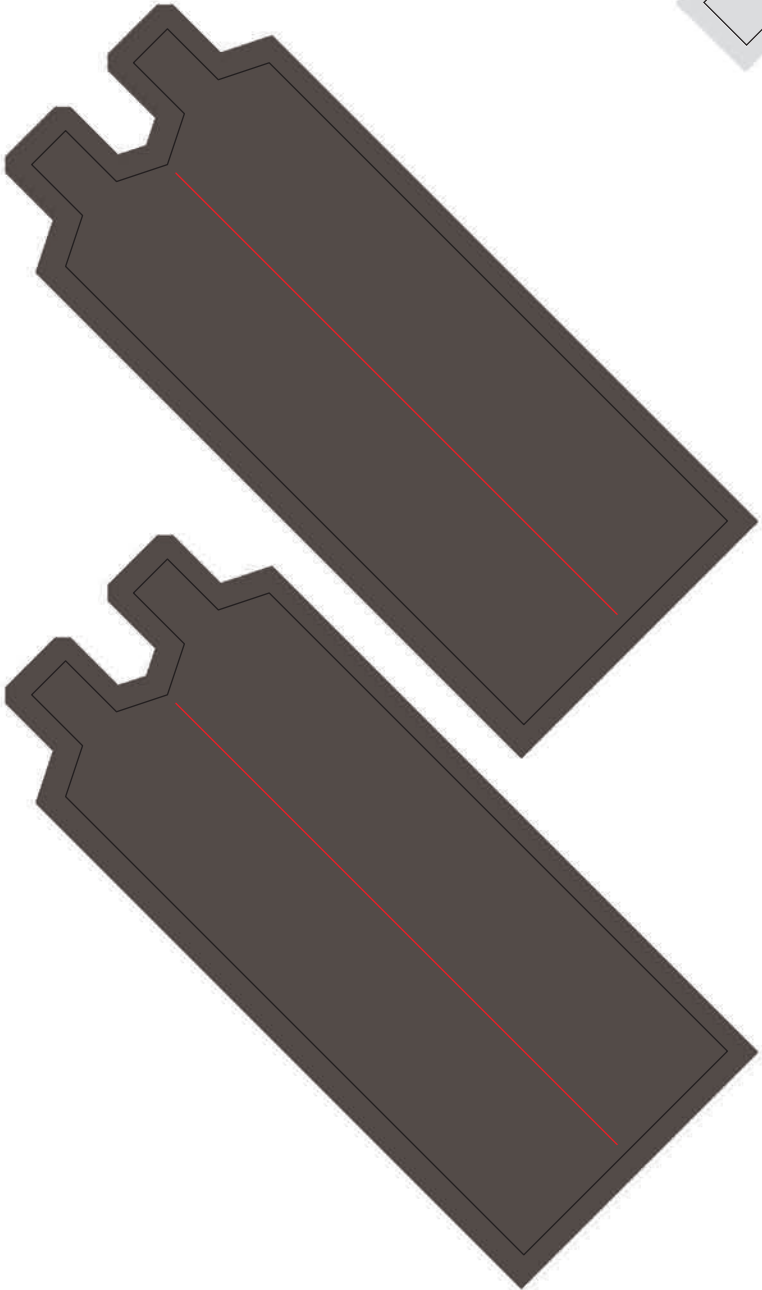
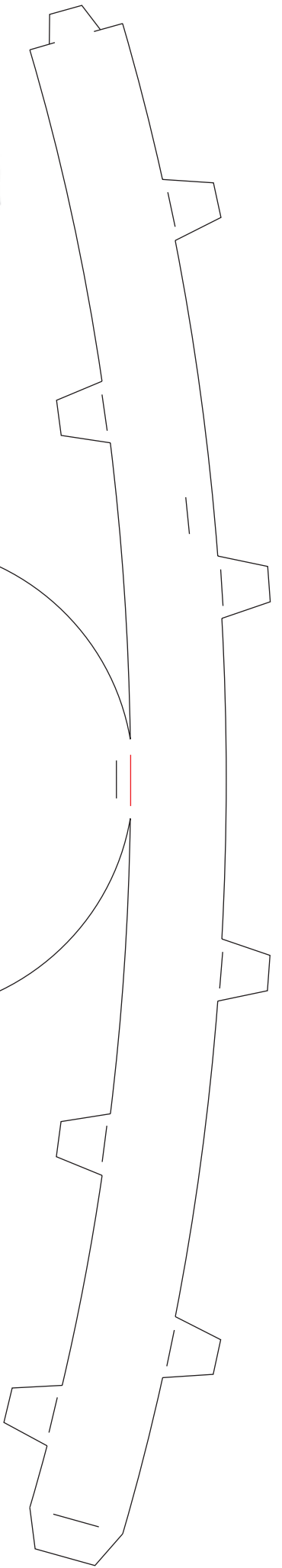
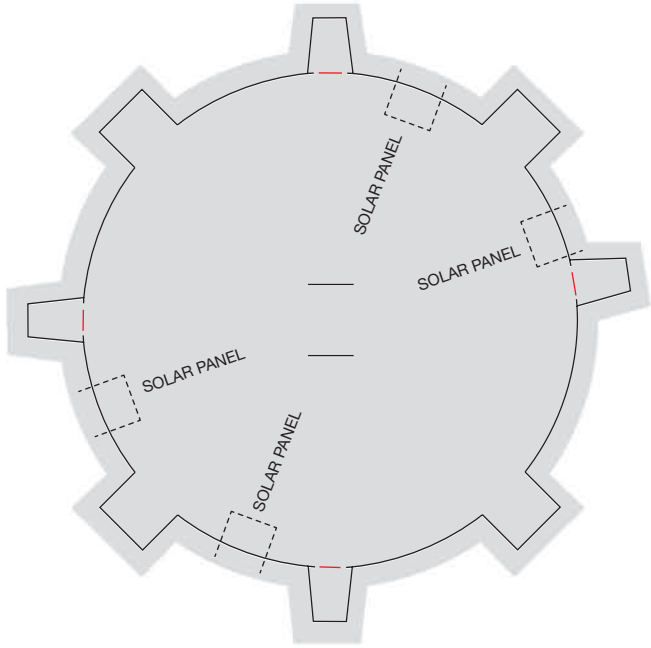
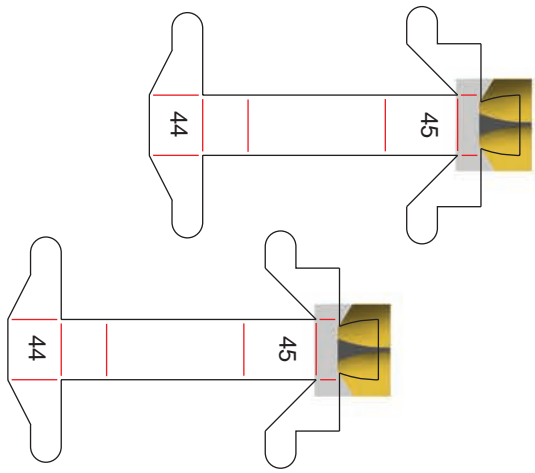

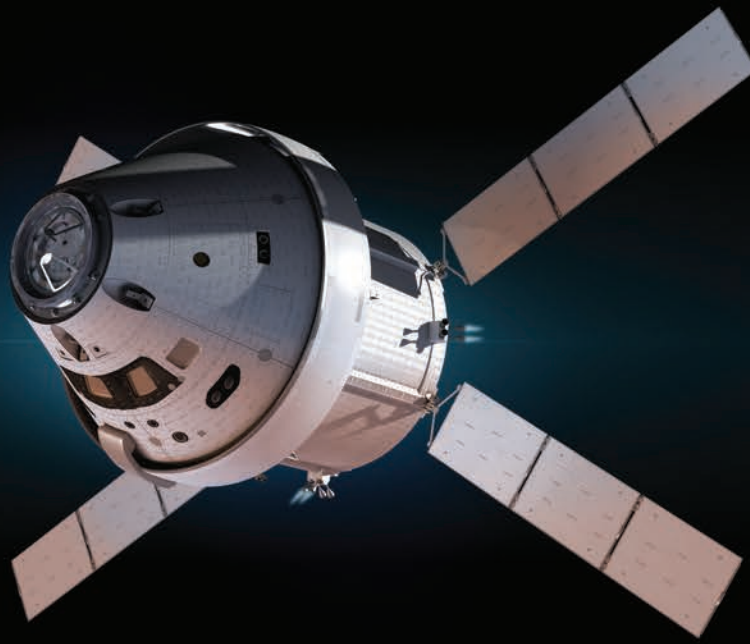

ORION

MULTI-PURPOSE CREW VEHICLE

DESK MODEL



[Facebook.com/NASAO Orion](https://www.facebook.com/NASAO Orion)



[Twitter.com/NASA.Orion](https://twitter.com/NASA.Orion)



[Facebook.com/NASASLS](https://www.facebook.com/NASASLS)



[Twitter.com/NASA_SLS](https://twitter.com/NASA_SLS)



Orion

70 ton Space Launch System