

International Council of Associations for Science Education

# Primary Science Activities Around the World

Source Book 1  
Stepping into Science Project

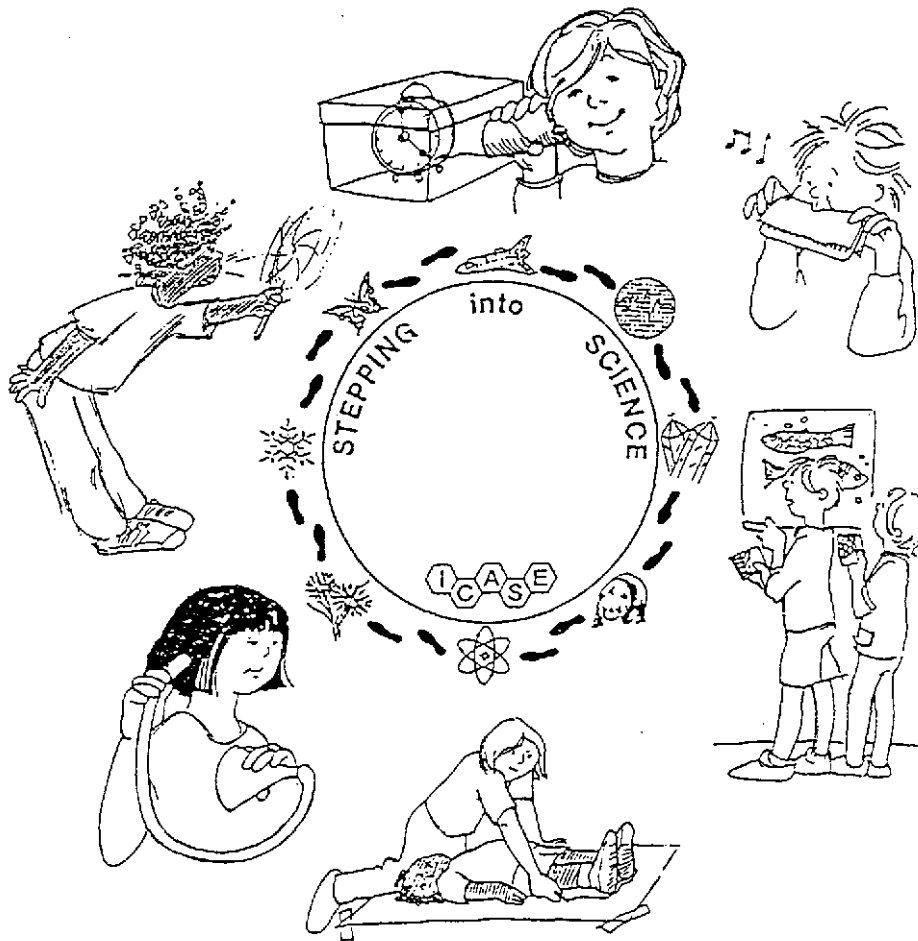

Compiled by  
Yunus Sola  
Sue Dale Tunnicliffe

# Preface

ICASE is pleased to publish this Source Book *Primary Science Activities Around the World*. This Source Book is an exciting addition to the growing number of ICASE publications available to science teachers and educators around the world. *Primary Science Activities Around the World* provides practical activities which will make an important contribution towards the growing demand for quality science and technology resources for primary and elementary school teachers in both developing and developed nations.

I would like to pay tribute to the vision and energy of Sue Dale Tunnicliffe, the ICASE Project Officer for Primary Science and Technology who, through her extensive contacts throughout the world, has produced a Source Book with a truly international dimension. Without the painstaking work of Yunus Sola, a key member of the ICASE Stepping into Science Committee who gave hours and hours of his time in compiling the activities submitted from every corner of the globe, this Source Book would have never appeared. I would also like to acknowledge the editorial contributions of John Penick, ICASE Special Projects Officer, and Samantha Morley, Education Officer at the National Science and Technology Centre in Australia.

We are grateful to Professor Wynne Harlen for her Foreword. Her work has guided many of us along our science teaching paths and we are honoured that she has contributed to the Source Book in this way.

ICASE values the efforts of all those involved – those contributing and trialling the activities, as well as those compiling and editing the contributions. Together they have produced a timely resource which brings an international perspective to primary science and technology education. This publication will play a key role in the work of the ICASE Stepping into Science Project in linking primary and elementary teachers and children around the world through the sharing of ideas and resources.

Brenton Honeyman  
President, ICASE  
March 1994

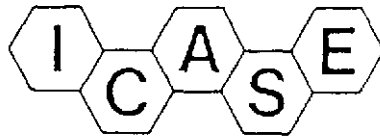

# Primary Science Activities Around the World

## Source Book 1 Stepping into Science Project

**Compiled by:**

Yunus Sola, ICASE Stepping into Science Committee, UK  
Sue Dale Tunnicliffe, ICASE Project Officer, Primary Science and Technology, UK

**Edited by:**

Brenton Honeyman, President ICASE, Australia  
Samantha Morley, The National Science and Technology Centre, Australia  
John Penick, ICASE Special Projects, USA

**Artwork by:**

Penny Janic, Australia

**ISBN: 0 86357 214 6**

Copyright © 1994 International Council of Associations for Science Education  
Activities published in this Source Book may be reproduced for classroom use.  
ICASE and its officers assume no liability with respect to  
the use of the information within.

**Printed by:** The Association for Science Education,  
College Lane, Hatfield, Herts, AL10 9AA Tel: 01707 267411

# Contents

	Page
Preface	ii
Contents	iii
Foreword	v
Introduction	vii
Contributors	viii
<b>Activity Title</b>	<b>Theme</b>
Charged up science	Static electricity 1
Dancing salt	Sound 2
Secret sound box	Sound 3
Comb and paper sounds	Sound 4
Turkey gobbler	Sound 5
Making a stethoscope	Sound 6
Wave generator	Waves 7
Gravity on a sheet	Gravity 8
Balancing bird	Centre of mass 9
Making windmills	Air flow 10
Blowing out candles	Air flow 11
Wind roller	Air flow 12
Spinning spook	Air flow 13
Parachute	Air flow 14
Ring wing glider	Flight 15
Egg in a bottle	Air pressure 16
Pneumatic rockets	Air pressure 17
Lifting with air	Air pressure 18
Simple fire extinguisher	Combustion 19
Water wheel	Water 20
Swimming fish	Water, surface tension 21
Bubbles	Water, soap films 22
Soils and water absorption	Soil, water absorption 23
Floating a straw	Density 24
Cartesian diver	Pressure, buoyancy 25
Dancing spaghetti	Acids & bases, buoyancy 26
Making indicator paper	Acids & bases 27
Sifting sieves	Separation 28
Mystery tower	Separation 29
Whizzer spinners	Sight, colour 30
Now you see, now you can't	Sight, light 31
Hole in your hand	Sight, illusions 32
Olfactoria	Sense of smell 33
What's inside my body?	Human anatomy 34
I'm stuck!	Fair testing 35
My coffee is cold	Heat flow, insulation 36

Model greenhouse	Heat, greenhouse effect	37
Magnet sticks	Magnetism	38
Indian rope trick	Magnetism	39
Feast for ants	Animal behaviour	40
Animal colours	Animals	41
Animal patterns	Animals	42
Where do legs go?	Animal structure	43
How big is a whale?	Animals, drawing to scale	44
Drawing animals	Animals, communication	45
Nature trail	Animals, plants, ecology	46
Leaf pollution	Plants, air pollution	47
Dramatic seeds	Plants	48
Measuring trees	Plants, measuring height	49
Cup planetarium	Astronomy	50
What's going on? Ideas for discussing activities with children		53
Stepping into Science Advisory Committee	inside back cover	
Invitation to primary schools around the world	back cover	

# Foreword

Science is about developing understanding of the physical and biological aspects of our world. What scientists do in developing understanding of things at the frontiers of knowledge is not all that different from what children do in making sense of experiences which are new to them. Both are struggling to understand something which they did not previously understand. Learning science and doing science become the same thing if we are concerned with understanding rather than rote learning. The activities in this *Source Book* are designed to advance learning with understanding by giving pupils opportunities to investigate things for themselves.

Why is this kind of active experience so important to learning with understanding? To answer this question we have to look a little more closely at what is involved in this kind of learning. When faced with a new experience, we all (children, scientists and the rest of us) begin to make sense of it by searching through our minds for ideas from past experience which may be relevant, then we test out these ideas to see if they 'work'. For example, if faced with an object we have never seen before we may use previous experience to suggest that it is, say, natural material rather than made from plastic. To test this idea we use existing ideas about natural material to make a prediction about its properties, which can be compared with the evidence. The result may confirm the original view or it may cause us to revise it. Whatever happens, the emerging idea makes sense to us because we have seen the evidence and we have done the thinking for ourselves.

Children go through the same processes in trying to make sense of new objects or events. But, because of their more limited experience they may not have an idea available to them which really fits and they use what seems most reasonable to them. This gives rise to what appear to be some 'strange' ideas put forward by children. For example, children often believe things that grow only do so at night, that rust exists in the body of a metal and it is revealed as it wears away, that a seed and an egg contain the fully formed new individual in miniature, and that you only need one wire from a battery to a bulb to make it light. Such ideas might in the past have been dismissed as wrong or merely a childish fantasy, but recent research by science educators in many parts of the world has led to a different view. Children's ideas indeed emerge from their reasoning about their limited experience: things grow so slowly that children never see it happening and so conclude that it happens when they can't see it; a common experience is to find rust under a flake of paint that falls off painted iron railings, or even the body work of a car; when a seed germinates or an egg hatches, a completely formed living thing emerges; and if you look inside a torch there is only one obvious connection between battery and bulb. Many more examples could be given of where the basis of the ideas seems reasonable if considered from the child's point of view. But, of course, these ideas need to be developed or changed. As experience widens they will be found to be less helpful in making sense of the world around and need to be modified so that they fit a greater range of phenomena. Through these changes the ideas are brought closer to the accepted scientific view of things.

The view of learning to which this argument leads is that it is a change in ideas, not the acquisition of new ideas from scratch. It is consistent with the increasing recognition of the importance of learners taking a mentally active and creative part in constructing their own understanding. Ideas which children work out themselves make sense to them at least in terms of the evidence available to them at the time and their ways of reasoning. Because the new ideas make sense they are 'owned' by the learners. Also, they become part of the range of ideas that can be used to make sense of further

experience and will be further extended or modified in this ongoing process. Success in learning in this way means that ideas become gradually more extensive and thus more widely applicable. Ideas that are learned by rote can only be recalled and used in contexts similar to those in which they were learned. Ideas which are understood, because they have been developed by the mental activity of the learner can be applied to other contexts.

This may be all very well in theory but what about practice? There are two very important conditions required for this learning to take place. First, there must be opportunities for children to carry out investigations in which they can use and develop their ideas. For primary school children this means simple, uncomplicated, accessible and attractive activities which invite children to interact with real things and to test out their ideas. This *Source Book* provides a rich collection of activities which meet these requirements and which are capable of many extensions in which children can find answers to questions that arise in their minds in the initial exploration.

Second, it is important to pay attention to the processes by which children apply existing ideas and test them out on new experiences. These processes are variously described as process skills or cognitive skills and given titles such as observing, hypothesising, predicting, investigating, interpreting and drawing conclusions. They are used in linking an existing idea to a new experience, thereby creating a hypothesis — that the rust is inside the metal, for example. A prediction is then made on the basis of the hypothesis and more information is gathered and interpreted to form a conclusion as to whether the idea explained the observations. But note that what emerges as the conclusion depends crucially on the way in which the processes are carried out. If this is not done with rigour, in a scientific manner, then emerging ideas may be accepted which ought to have been rejected, and vice versa. Thus the change and development of ideas, the learning, depends on the way the mental and physical processes are carried out.

Thus in using the ideas in this book it is important that children are involved in the thinking and reasoning, that they are making suggestions, trying to explain things, seeing if what they predict actually happens. They should not be following the instructions like a recipe for making a cake, for doing alone is not enough for learning to take place; the activities must engage the mind as well as the hands. They should also engage the curiosity of teachers and pupils alike and make learning thoroughly enjoyable and exciting for all.

Professor Wynne Harlen

# Introduction

Welcome to the first *ICASE Primary Science Activities Around the World Source Book*. These activities have been contributed by colleagues around the world. Some have been developed by teachers in one part of the world, and are in popular use by teachers in other parts of the world. The activities are appropriate for children's science learning from about four years to twelve years of age.

The essence of this *Source Book* is that you modify the activities to suit your particular teaching situation. As the teacher, you are in the best position to decide the level at which it is appropriate to use the activities. You know the local syllabus and curriculum requirements. You know the previous experiences of the children and you are in the best position to identify the experiences they need before starting these activities. You need to decide what key questions or variables, for example, can be introduced or omitted to modify the level of the activity.

You also need to adapt the style of science experience to suit your pupils. You may be working in a direct instruction teaching approach or in a discovery learning situation. These activities suit either approach. Each activity has a challenge which can be used to introduce it. You can use the approach suggested in the activity, or present it in your own way.

At the end of the *Source Book*, you will find some simple explanations for each of the activities. You will find these ideas helpful when discussing the activities with the children.

All activities use easily accessible resources, although some items are more accessible than others. You may need to substitute appropriate resources from your local area where necessary.

These activities have been designed to be safe under supervision and have been trialled by the educators submitting them, and by the editors. However, make sure that you try the activities yourself first and adapt them to meet safety requirements.

We hope that you find this first *Source Book* a useful resource, and that your pupils find it interesting to work on activities which are shared with children all over the world. Referring to each activity's country of origin may provide a link to studies of other countries and cultures as well.

This publication is the result of a worldwide call for contributions. Please send more practical activities, especially from countries not yet represented here, so that future *Source Books* will feature a wide international coverage.

The activities in this *Source Book* may be copied for classroom use.

Sue Dale Tunnicliffe  
ICASE Project Officer  
for Primary Science and Technology



# Contributors

Name/Association	Country
Saroja Abeyathunge, SLASME	Sri Lanka
George Allison	USA
S P Ariyawathie, SLASME	Sri Lanka
Angela Baker	UK
William Boone	USA
Neil Burton, ASE	UK
CESI	USA
Cynthia Clark, CESI	USA
Sujatha Dharmaratne, SLASME	Sri Lanka
Raphael Douglas, ASETT	Trinidad
Terry Groseclose, CESI	USA
Karen Heizer, CESI	USA
Yvonne A Johnson, CESI	USA
Zoe Kavogli	Greece
Marilyn Martin	USA
Althea Maund, ASETT	Trinidad
Peter Metcalf	Australia
Hafiz Iqbal Muhammad	Pakistan
Firoza Mussa	UK
Jim Otuka, STAN	Nigeria
Dorothy Pace, CESI	USA
Beck Ruby, CESI	USA
Joan Ruswick	USA
SLASME	Sri Lanka
Yunus Sola	UK
Maise Southwell	Antigua
STAN	Nigeria
Texas Science Teachers	USA
Sue Dale Tunncliffe	UK
Alan Warner	UK
Ella Young	UK

ICASE is grateful to these contributors who have developed, trialled and provided practical activities for inclusion in this Source Book. More contributors are invited to forward activity ideas for inclusion in future Source Books. Please forward to: Sue Dale Tunncliffe, ICASE Primary Science and Technology Officer, 18 Octavia, Bracknell, Berkshire RG12 7YZ, UK.

STEP ACTIVITY

# Charged up science

Contributed by Joan Ruswick, USA

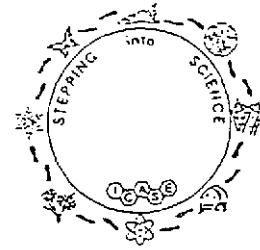

**Challenge:** How can you make cereal dance?

## What you need

- see-through plastic cup
- plastic cling wrap
- grains of puffed rice cereal
- rubber band
- dry woollen cloth

## What to do

Place several grains of puffed rice in the plastic cup. Cover the cup with cling wrap and secure with a rubber band. Rub the cling wrap using a dry cloth. What happens?



## More to do

- How does the number of rubs affect the number of puffed rice grains attracted to the plastic? Design an experiment to find out. Record your observations in a chart.
- Experiment with different types of cloth and compare results. Which type of cloth makes the puffed rice 'dance' more?
- What happens if you add more or less puffed rice grains in the cup?
- What happens when you sprinkle some water in the cup? What happens if the puffed rice grains are wet?
- What other things act like the cereal? Add various things in the cup to find out if they are attracted to the plastic.
- What happens when you rub an inflated balloon and hold it near your hair?

STEP ACTIVITY

# Dancing salt

*Contributed by Zoe Kavogli, Greece*

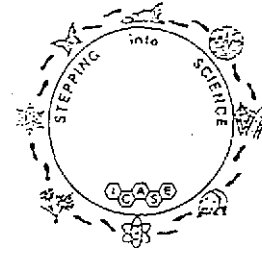

**Challenge:** How can you make salt dance?

## What you need

- tin can
- balloon
- salt
- tuning fork

## What to do

Cut off the neck of the balloon and stretch it over the open end of a tin can. Sprinkle some salt over the stretched rubber. Strike a tuning fork and hold it just above the stretched rubber balloon. What happens?

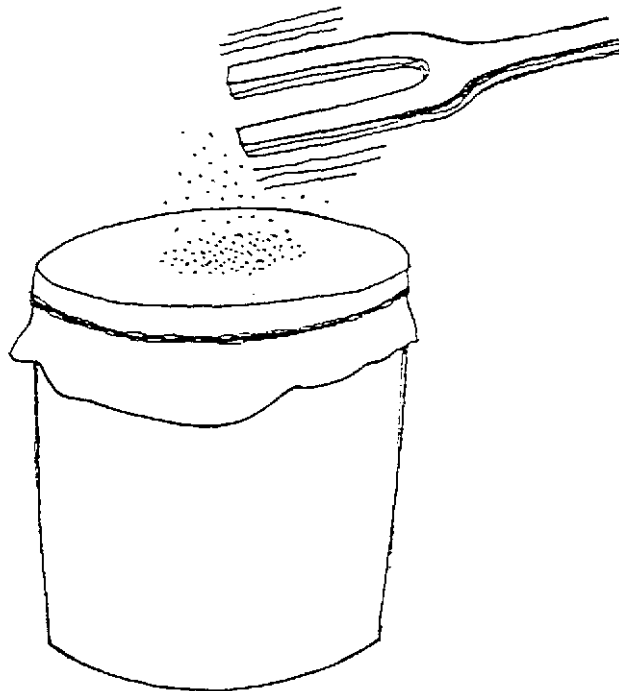

## More to do

- How does the position of the tuning fork affect the salt? What happens if the tuning fork touches the can? What happens if it touches the balloon?
- Compare the results of using different size tuning forks.
- What effect do you find when using other vibrating objects such as your own voice or the loudspeaker of a radio?
- What things other than salt will 'dance' on the stretched balloon?

# Secret sound box

Contributed by SLASME, Sri Lanka

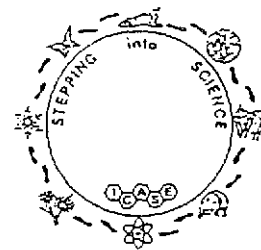

**Challenge:** How can you hear sounds inside a box?

## What you need

- shoe box or cardboard box with lid
- ticking clock
- cardboard tube

## What to do

Before you put the clock into a box, listen to it.

What can you hear?

Will you be able to hear the clock if you put it inside a closed box?

Let's try it! Put the clock inside a box and put on the lid. How can you tell if the clock is still ticking? Here is one way.

Use a cardboard tube (or make one by rolling up some paper). Put one end of the tube on the box and the other end against your ear. What do you hear?

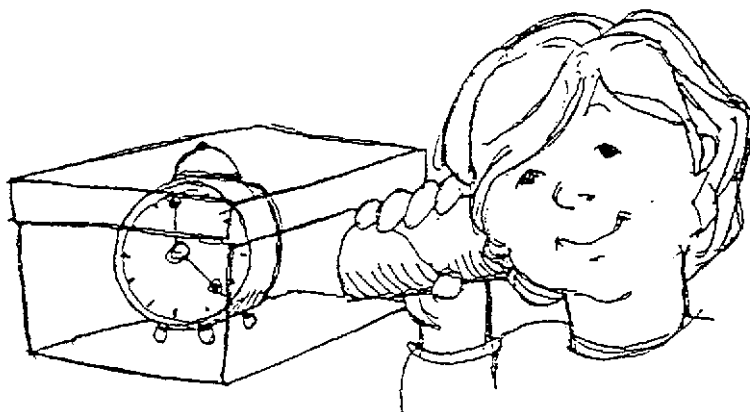

## More to do

- How does the length of the cardboard tube affect how well you can hear the ticking clock inside the closed box?
- What else can you listen to using the cardboard tube?
- What other things can you use so that you can hear faint noises?

STEP ACTIVITY

# Comb and paper sounds

Contributed by SLASME, Sri Lanka

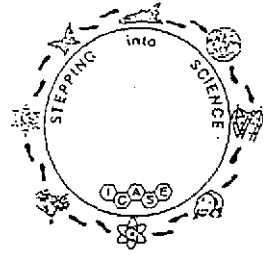

**Challenge:** How can you make sounds using a comb and paper?

## What you need

- plastic comb
- clean paper

## What to do

Run your finger over the teeth of the comb. What kind of sounds can you make? This is one way to make a sound using a comb. Let's try another. Fold some paper over the teeth. You have made a musical instrument! Play it by holding the comb and paper between your lips as shown, and blow air past the comb as you hum. What do you hear? What do you feel as you play the instrument?



## More to do

- How can you make the sound lower or higher?
- What happens if you suck air instead of blowing air past the comb and paper?
- What happens to the sound if you use different types of paper?
- What happens to the sound if you use combs with different size teeth?

STEP ACTIVITY

# Turkey gobbler

Contributed by CESI, USA

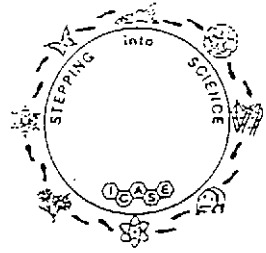

**Challenge:** How can you make wild noises?

**What you need**

- paper or plastic cup
- toothpick
- small piece of paper towel
- string
- water

**What to do**

Use a toothpick to make a small hole through the bottom of the cup. Put one end of the string through the hole and tie it to the toothpick as shown. Wet the paper towel and pull it along the string. First, try making short, jerky movements as you pull. Can you make a sound like a gobbling turkey?

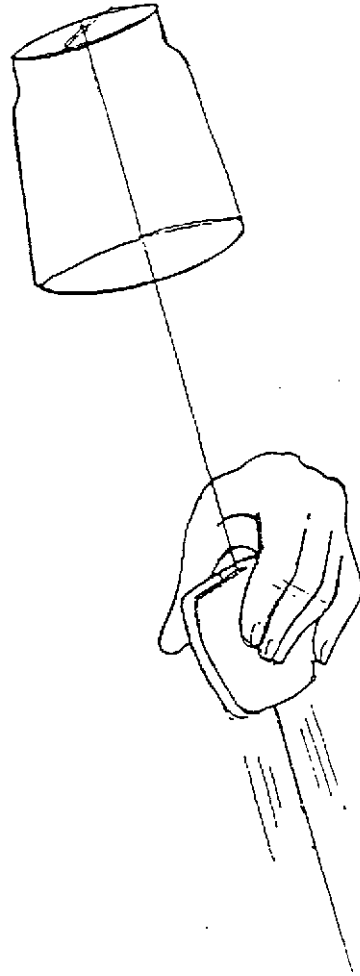

**More to do**

- Try making different wild sounds using the cup.
- What happens to the sounds produced if you use different size cups or cups made of different materials?
- What happens if you use different types and thicknesses of string? Try using cotton, wool or fishing line? Does the length of the string make any difference?
- What happens if you use dry, instead of wet paper towelling? What other materials can be used instead of paper towelling?

STEP ACTIVITY

# Making a stethoscope

*Contributed by Hafiz Muhammad Iqbal, Pakistan*

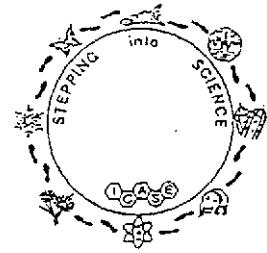

**Challenge: Can you listen to your own heart?**

## What you need

- rubber or plastic tube
- plastic funnel

## What to do

Fix one end of the tube to the funnel. You have made a simple stethoscope! Place the funnel against your chest and the tube against your ear as shown. What can you hear? Move the funnel to different places until you can hear your heart beating. Count the number of heart beats in 30 seconds.

Walk around slowly, then listen to your heart again. Count again the number of heart beats in 30 seconds. Has there been a change? Does your heart sound any different?

Do some exercises or run for a short time. Count the number of heart beats in 30 seconds. Has there been a change?



## More to do

- What other sounds in your body can you listen to? Can you hear the sound of your lungs as you breathe air in and out?
- What else can you use your stethoscope to listen to?
- How can you make your listening device work better? Design and make a better listening device and test it.

STEP ACTIVITY

# Wave generator

Contributed by Terry Groseclose, USA

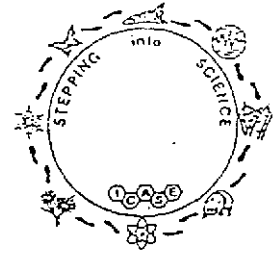

**Challenge:** How can you make waves using straws and paper clips?

## What you need

- masking tape
- straws
- paper clips or plasticine

## What to do

On a flat work surface, spread out a length of masking tape with the sticky side up. Stick the straws onto the tape about 1 cm apart. Push a paper clip in each end of every straw, or squeeze plasticine into each end. Place another length of masking tape over the first one to fix the straws in place. Hold the top of the tape with one hand as you push one end of the bottom straw. What happens?

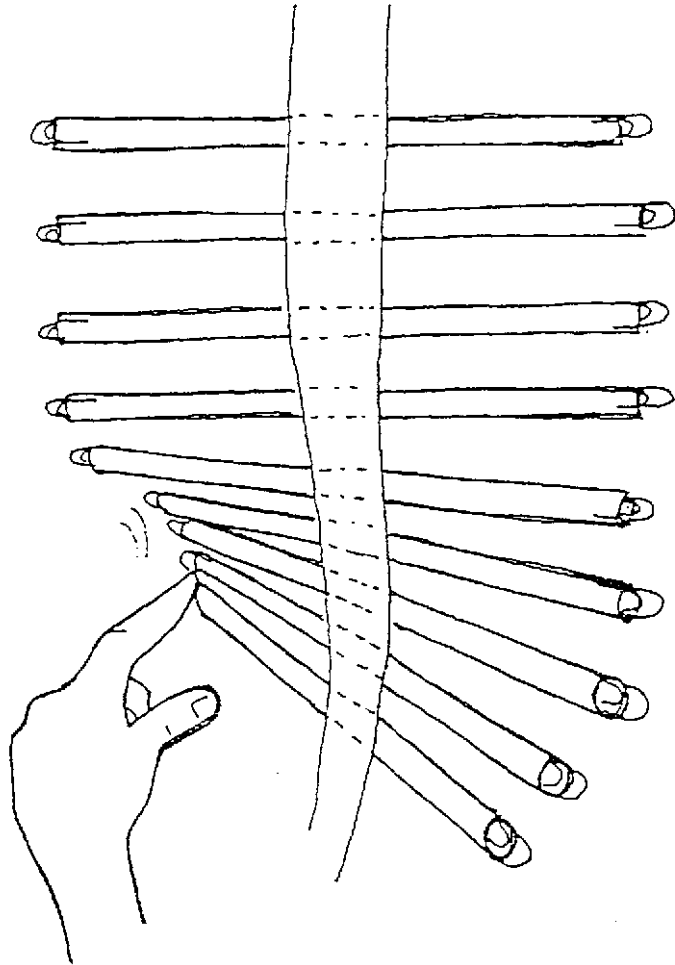

## More to do

- Push one end of the top straw. What happens? Push one end of a middle straw. What happens?
- What happens if you make the straws shorter or longer?
- What happens if you add more weight to the straws?
- Instead of holding the tape with your hand, attach each end between two chairs. Push one end of a straw. What happens?



## STEP ACTIVITY

# Gravity on a sheet

*Contributed by William Boone, Indiana University, USA*

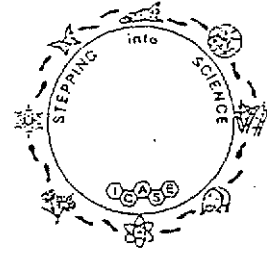

**Challenge:** How can you show the effect of gravity using a large tablecloth?

### What you need

- large tablecloth or sheet
- large stone
- marble

### What to do

When thinking about gravity, have you ever wondered what would happen to the path of a planet if it approached the Sun? Try this activity to find out.

You need four people to tightly hold the corners of a large tablecloth or sheet. Place a heavy object such as a stone in the centre of the cloth. This makes the centre of the cloth curve downward. Roll a marble so that it spirals around the stone. What happens?

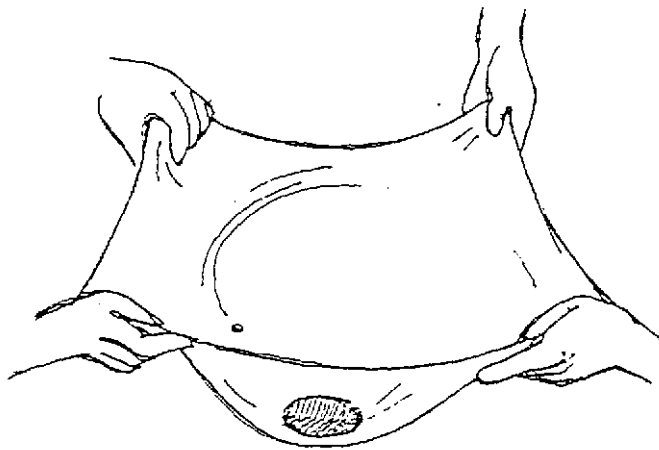

### More to do

- Change the speed and the initial angle of the marble as you roll the marble on the cloth. How does this affect its orbit?
- What happens if you use a lighter or a heavier weight in the centre of the cloth?
- What happens if you use different size spheres — small ball bearing, large marble, table tennis ball, golf ball?
- Discuss how space probes such as the Pioneer spacecraft make use of a 'sling shot' effect to move from one planet to another. How does the tablecloth activity demonstrate the 'sling-shot' effect?

STEP ACTIVITY

# Balancing bird

Contributed by Firoza Mussa, UK

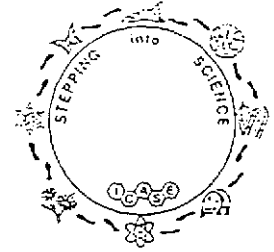

**Challenge:** How can you make a bird perch on your finger?

## What you need

- cardboard
- scissors
- pencil
- plasticine

## What to do

Use the diagram of a bird on this page as a 'template' to draw a bird on cardboard. Cut out the bird. Try balancing the bird so that it will perch on your finger. Can you do it? If not, try the next step! Attach some plasticine on the lowest point — the bird's tail! Does the bird balance on your finger now?

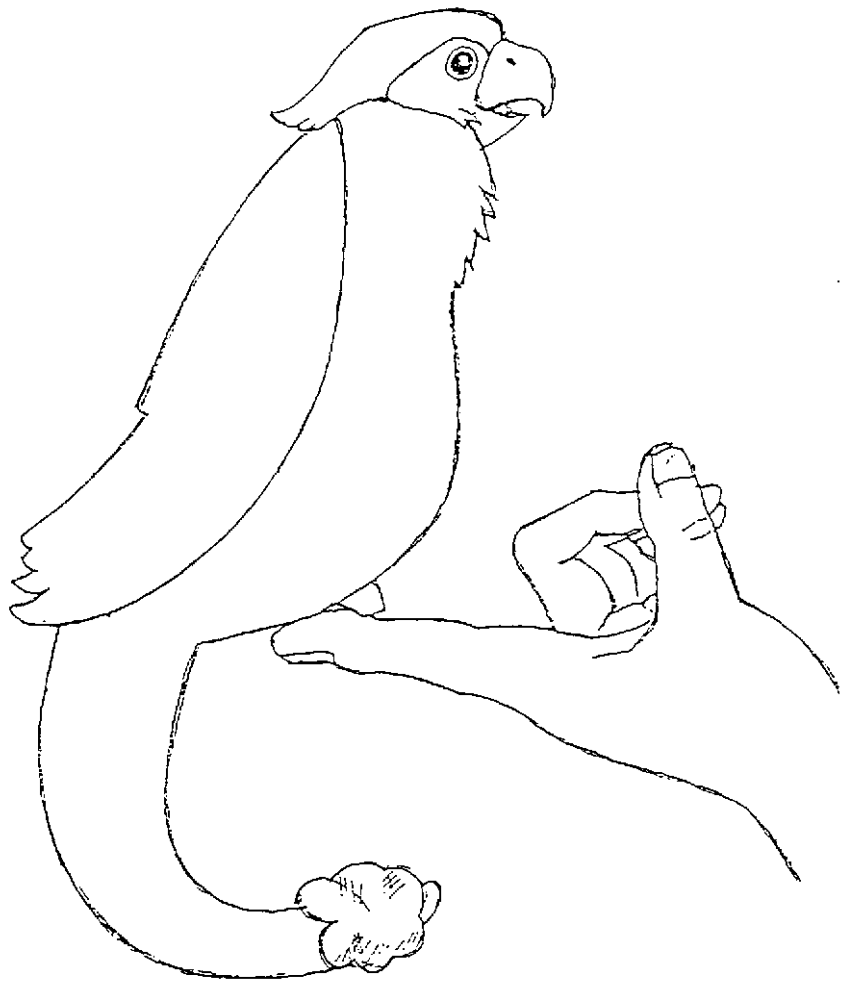

## More to do

- How much plasticine do you need on the tail for the bird just to balance?
- Try making other animal shapes and balancing them?
- Try making a tightrope walker. Design things to hold onto so that the tightrope walker maintains balance while doing stunts.

STEP ACTIVITY

# Making windmills

Contributed by Althea Maund, Trinidad

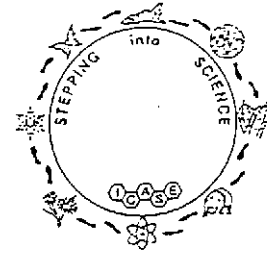

**Challenge:** How can you design a windmill that turns quickly?

## What you need

- paper
- stick or drinking straw
- long pin
- beads, bead pasta or small pieces of tubing
- scissors

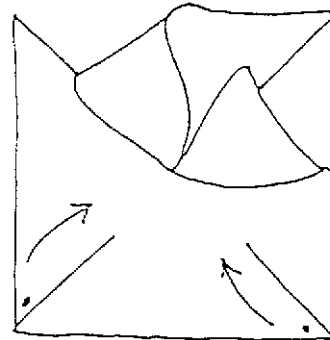
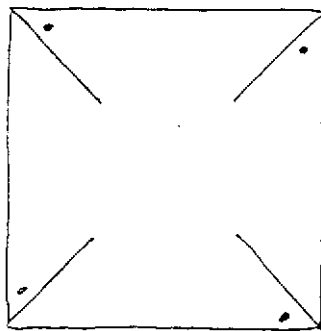

## What to do

With the help of these diagrams, make your own windmill. Use beads or short pieces of tubing or bead pasta for 'spacers' to help the windmill turn smoothly.

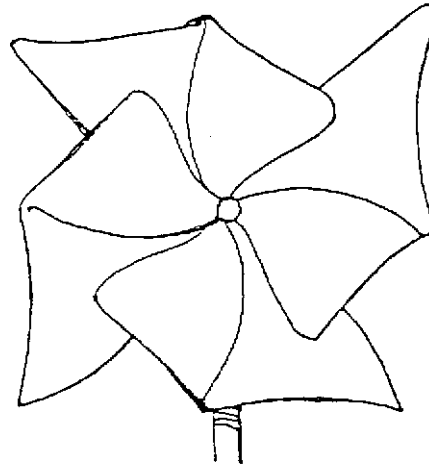

## More to do

- What things might affect how well the windmill works? Does the size or shape of the blades affect how fast it spins? Consider each one as you try and design windmills which will spin faster.

## STEP ACTIVITY

# Blowing out candles

Contributed by Yunus Sola, UK



**Challenge:** How can you blow out a candle when it is behind something?

### You need

- safe surface to work on
- candle
- matches
- cardboard
- plasticine
- large tin can
- jar lid or saucer

### What to do

Prepare a safe surface to work on. Aluminium foil or a large metal cooking tray will help to keep this activity safe. Use plasticine to hold the cardboard upright. Use a little plasticine to hold the candle upright in a jar lid or in a saucer. Place the candle behind the cardboard, then light the candle. Try to blow out the candle by blowing towards the cardboard. What happens to the candle flame? Next, place the candle behind the large tin and light the candle. Try to blow out the candle by blowing towards the tin. What happens to the candle flame? Can you blow it out?

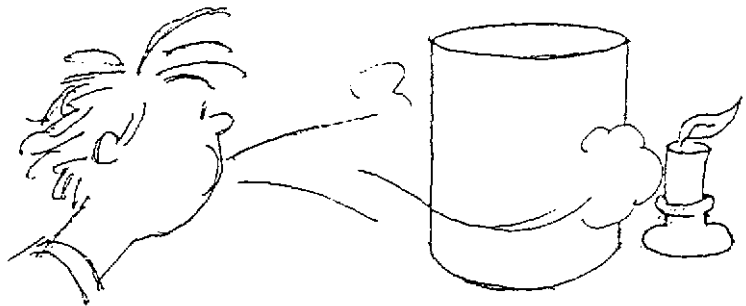
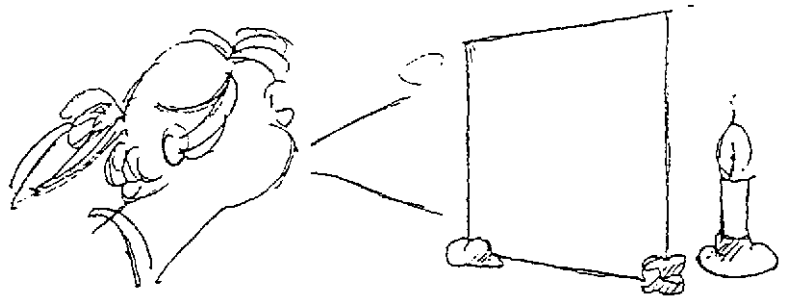

### More to do

- How could you shape the cardboard so that you can blow the candle out? Are there shapes other than a cylinder which enable you to blow out a flame?
- Place the candle in front of the tin. Blow out the candle flame so that a trail of 'smoke' remains. Can you see the 'smoke' trail bending around the tin as you gently blow towards the tin?

STEP ACTIVITY

# Wind roller

Contributed by Marilyn Martin, USA



Challenge: How can you make a wind powered roller?

## What you need

- cardboard
- pencil
- scissors

## What to do

Use the diagram of a roller on this page as a 'template' to draw a roller on cardboard. Cut around the outside, then punch a hole in the middle. Cut along the straight lines, then fold the fins in opposite directions as shown. Take your roller outside and roll it along a flat surface.

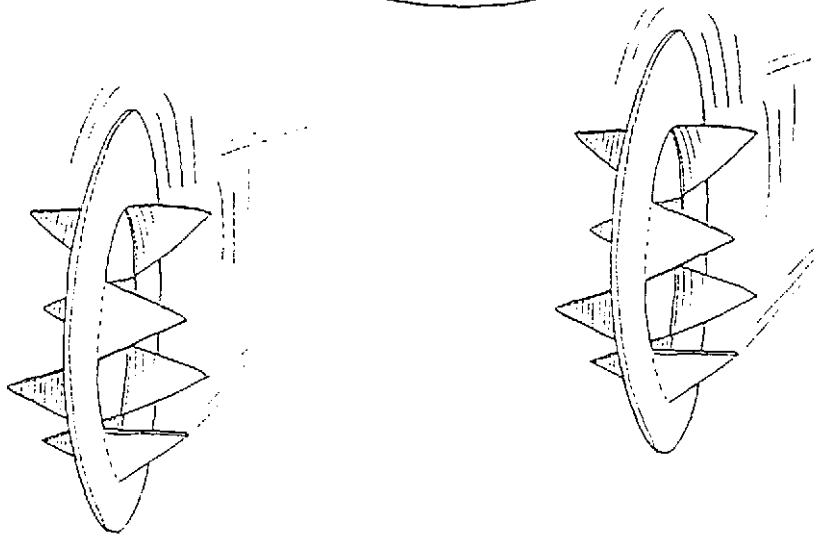
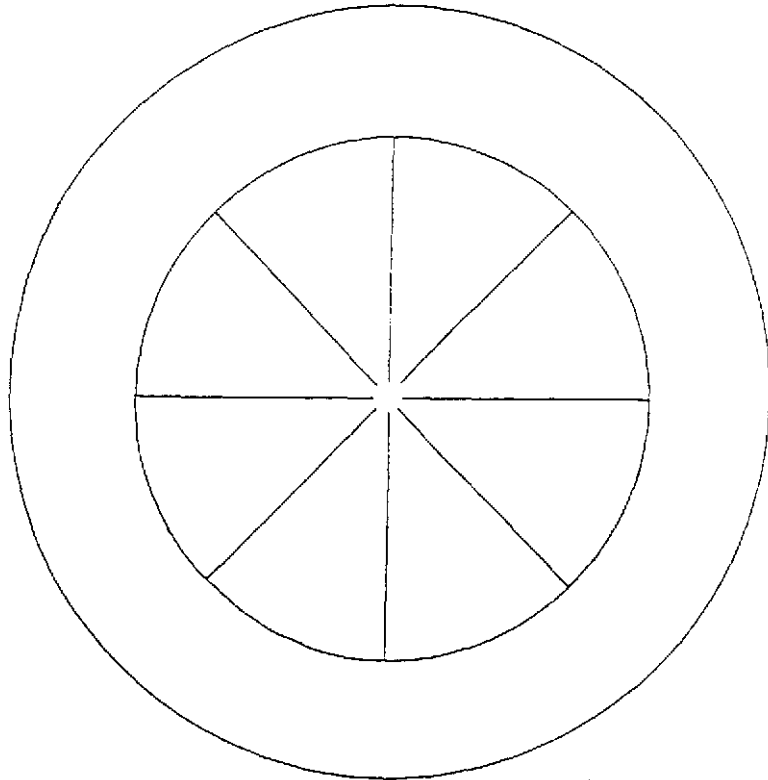

## More to do

- How does the wind affect the roller? Does an indoor fan have the same effect?
- What factors affect the roller? Design and make different rollers to test the effect of changing the size of the roller, changing the size of the fins, changing how much the fins are folded, increasing the fold of one fin and decreasing the fold of the next fin.

STEP ACTIVITY

# Spinning spook

Contributed by CESI, USA

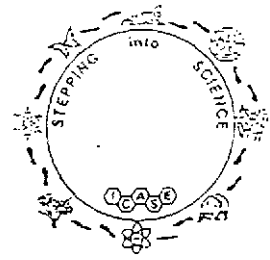

**Challenge:** How can you make a spinning spook?

## What you need

- different types and thicknesses of paper
- paper clip
- scissors

## What to do

Use the diagram of the spook on this page to help you draw a spook. Cut out the spook. Drop the spook and observe how it falls to the ground. Does it spin as it falls?

Try bending one arm of the spook. How does this affect the fall? Try adding a paper clip on the tail of the spook. How does this affect the fall? What else could you change that may affect the way that the spook falls? Try it.

Each time you change something make your test fair. How will you do this?



## More to do

- What factors help the spook to spin as it falls? Design different shapes or try different thicknesses of paper to test these factors.

## STEP ACTIVITY

# Parachute

Contributed by Jim Otuka, Nigeria

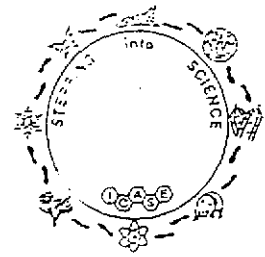

**Challenge:** How can you make a parachute and control it?

### What you need

- square pieces of paper
- thread
- scissors
- paper clip
- small pebble or plasticine

### What to do

Use the diagram on this page to help you draw a design for a parachute canopy using a piece of paper.

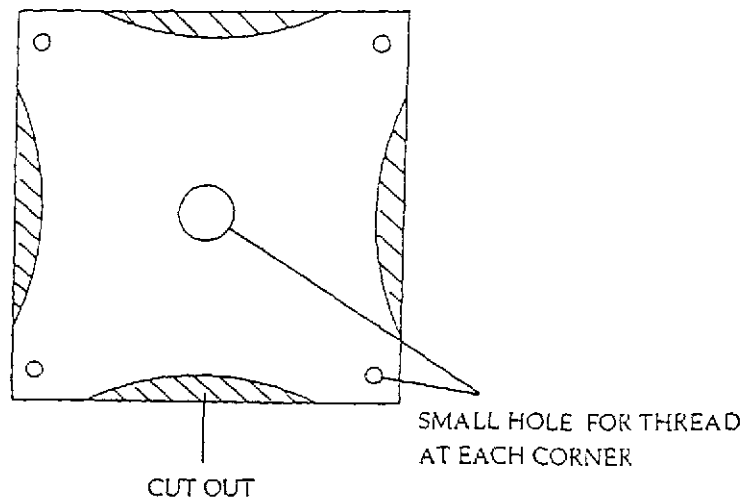

Cut out the canopy and the holes. Tie thread through the corner holes and attach the ends to a paper clip. Tie a small pebble to the paper clip, or attach some plasticine to the clip. Now you are ready to test your parachute. Let it fall to the ground. What happens? Adjust the size of pebble, or amount of plasticine so that the parachute falls slowly.

Make one thread shorter. What effect does this have on the way the parachute falls? Try ways to make the parachute move in a certain direction as it falls.

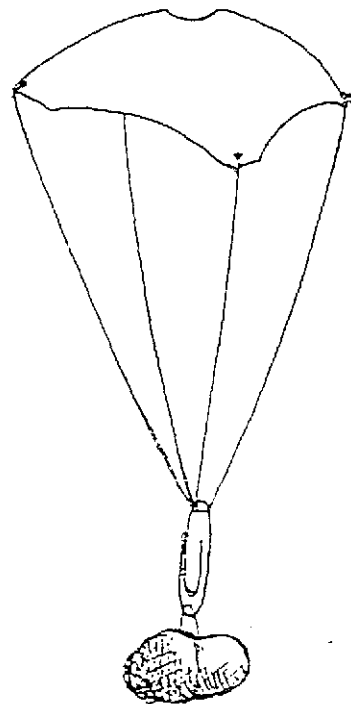

### More to do

- What factors affect the falling speed of the parachute? Try different thicknesses of paper or other materials. Try larger or smaller canopies. Try placing holes or slits in the canopy in different positions. Remember to test in a fair way each time you make a change.
- Design a parachute with three sides and three strings.

## STEP ACTIVITY

# Ring wind glider

*Contributed by George Allison, USA*

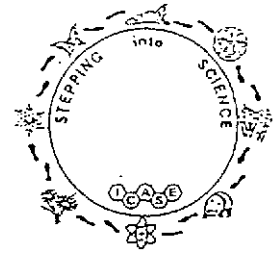

**Challenge:** How can you make a ring wing glider that flies?

### What you need

- straw
- longer strip of paper (eg 15 cm x 2 cm)
- shorter strip of paper (eg 12 cm x 2 cm)
- scissors
- glue or sticky tape
- ruler

### What to do

Use scissors to cut two strips — one shorter than the other. Make each strip into a ring. Stick the smaller ring onto one end of the straw. Stick the larger ring onto the other end as shown. You have made a ring wing glider! Hold the straw so that the smaller ring is at the front. Throw the glider forward. Can you make it fly?

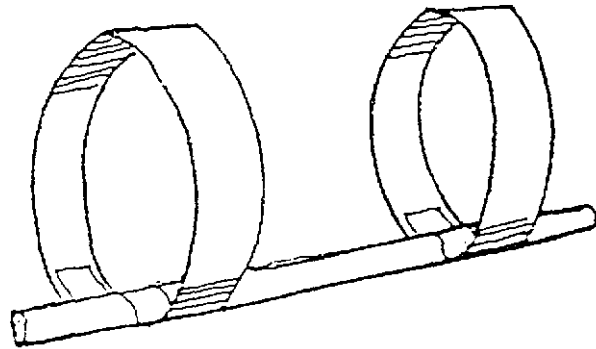

### More to do

- What happens if you launch the glider with the larger ring at the front?
- What factors affect how the glider flies? Design and make different ring wing gliders to test the effect of changing the length of the straw, changing the size of the rings, changing the position of the rings on the straw, changing the way the glider is launched.
- The French designed an early ring wing plan. The design below is the NASA Lockheed-Georgia Ring Wing Plane.

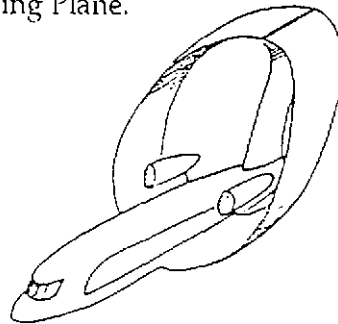



STEP ACTIVITY

# Egg in a bottle

Contributed by Zoe Kavogli, Greece

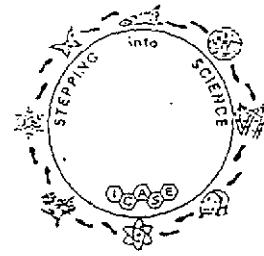

**Challenge:** How can you put an egg into a milk bottle?

You need

- eggs
- milk bottle
- matches
- paper
- tray to stand bottle on

What to do

Remove the shell from a hard boiled egg. Light a small coil of paper and drop it into the milk bottle. Immediately place the egg on the mouth of the bottle. What do you see happening?

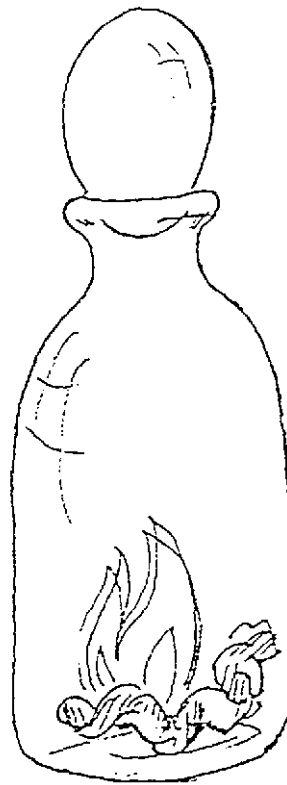

More to do

- What happens if you put more and more burning paper in the milk bottle?
- Does the size of the mouth of the bottle make any difference?
- Try another way to get the egg into the milk bottle. Heat the bottle with hot water inside and out. Pour the water out and place the egg on the mouth of the bottle. As the bottle cools, the air pressure inside becomes less and — what happens?
- Are there other ways to get the egg into the bottle?
- How could you get the egg out of the bottle?

STEP ACTIVITY

# Pneumatic rockets

Contributed by Neil Burton, UK

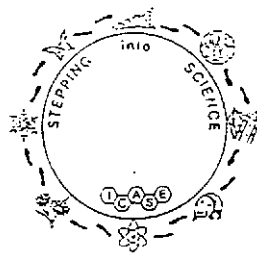

**Challenge:** How far can you launch an air propelled rocket?

## What you need

- plastic PET bottle or dishwashing liquid bottle
- cardboard toilet roll
- paper
- scissors
- sticky tape
- plasticine
- wide plastic straw
- thin plastic straw

## What to do

Method 1: Remove the bottle cap. Tape the toilet roll tube over the neck of the bottle as shown. Make a paper cone as shown and place it on the toilet roll tube. With a quick movement, squeeze the bottle — use two hands if you wish. What happens to the paper cone rocket?

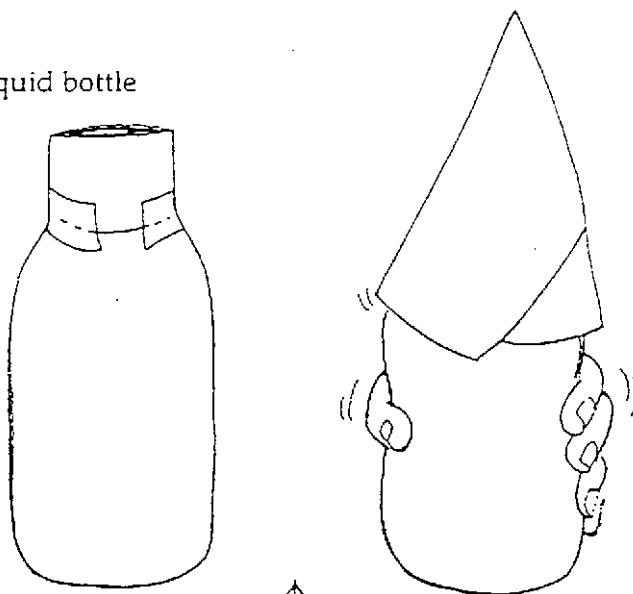

Method 2: Remove the bottle cap. Wrap a sausage of plasticine around a short length of the wide straw. Use this to plug the neck of the bottle as shown. Stick some plasticine to one end of the thin straw. Slide the thin straw down inside the wide straw as shown. Now you are ready to launch the straw rocket. Quickly squeeze the bottle — use two hands if you wish. What happens to the straw rocket?

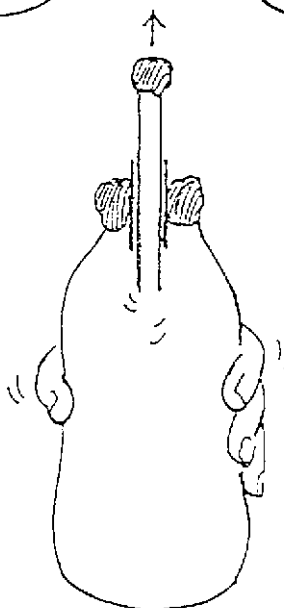

## More to do

- How can you make the paper cone rocket or the straw rocket go higher? Try cones of different shapes and sizes. Try straws of different lengths and with different amounts of plasticine. Try adding fins. Design other ways to launch your rockets.
- Design the paper cone so that it descends like a parachute. Design the straw rocket with a parachute so that it falls slowly back to the ground.
- How could you measure the height of each rocket launch?

STEP ACTIVITY

# Lifting with air

*Contributed by Jim Otuka, Nigeria*

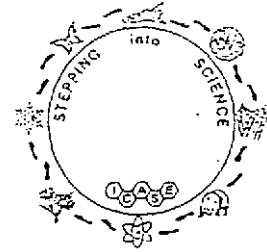

**Challenge: How can you lift things using air?**

**What you need**

- plastic bag
- book or object to lift
- straw
- sticky tape

**What to do**

Tape the open end of the plastic bag around the end of a straw. Blow air through the straw. What happens to the plastic bag? Squeeze the air out of the bag. Now place the plastic bag flat on a table. Put a book or some other object on the bag. Blow air through the straw. What happens to the book? What happens when you stop blowing?

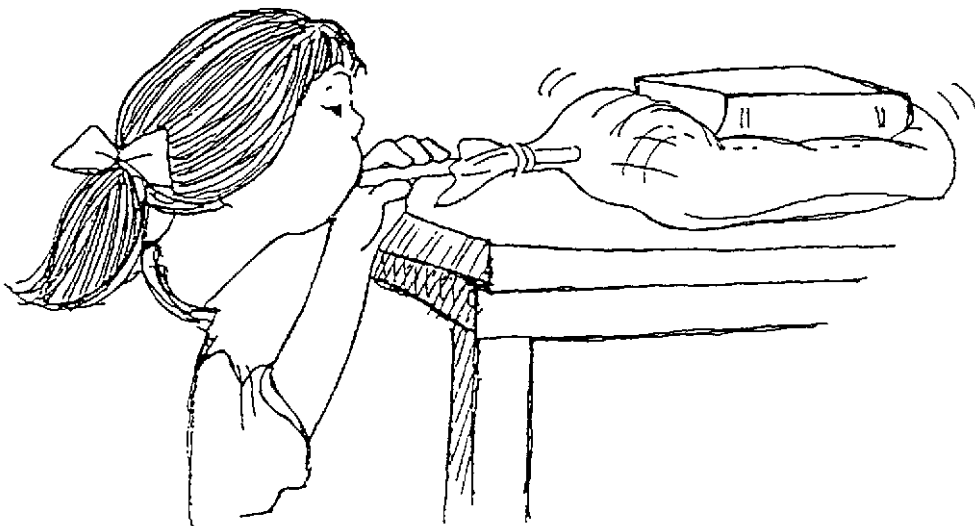

**More to do**

- Try lifting books with the same mass but different surface areas. What happens?
- Does the same amount of air lift a heavy load as far as a light load? Investigate this question.
- Try using different types of bags – paper bags, different types of plastic bags, even balloons! Which type lifts loads best? Can you explain why?

STEP ACTIVITY

# Simple fire extinguisher

Contributed by Ella Young, UK

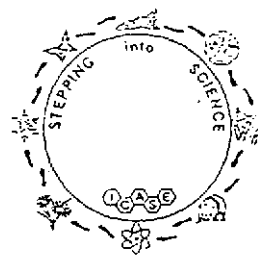

**Challenge:** How can you make a simple fire extinguisher?

## What you need

- clear glass bottle
- vinegar
- bicarb of soda (sodium bicarbonate)
- candle
- matches
- safe surface to work on

## What to do

Use a glass bottle. If you use a plastic bottle, it may catch on fire if too close to the candle flame. Add a few teaspoons of vinegar to the bottle. Tilt the bottle as you add a teaspoon of bicarb soda so that it stays half way down the side of the bottle.

Make sure that the surface is safe to light a candle, then light it. Slowly tip the bottle so that the vinegar runs down the sides and reacts with the bicarb soda. Be careful not to tip it out. Hold the mouth of the bottle over the candle flame as shown. What happens to the candle flame?

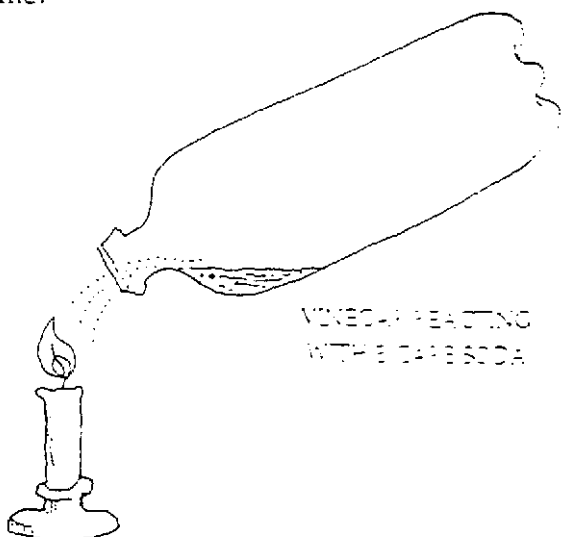

## More to do

- Light a number of candles. How many flames can you put out with the one bottle?
- Why does the bottle have to be held above the flame? Test your ideas by holding the mouth of the bottle below, or to the side of the flame.
- Put a balloon over the neck of the bottle as soon as the reaction starts. What happens?

STEP ACTIVITY

# Water wheel

*Contributed by Hafiz Muhammad Iqbal, Pakistan*

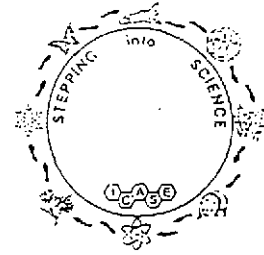

**Challenge: How can you make a simple water wheel?**

**What you need**

- bucket
- balloon
- water tap

**What to do**

Blow up a balloon and tie the neck so that it fits loosely in the bottom of the bucket. Place the bucket underneath a water tap. Turn the tap on so that water falls gently on one side of the balloon. What does the balloon do? Move the bucket so that the water falls on the other side of the balloon. What happens now?

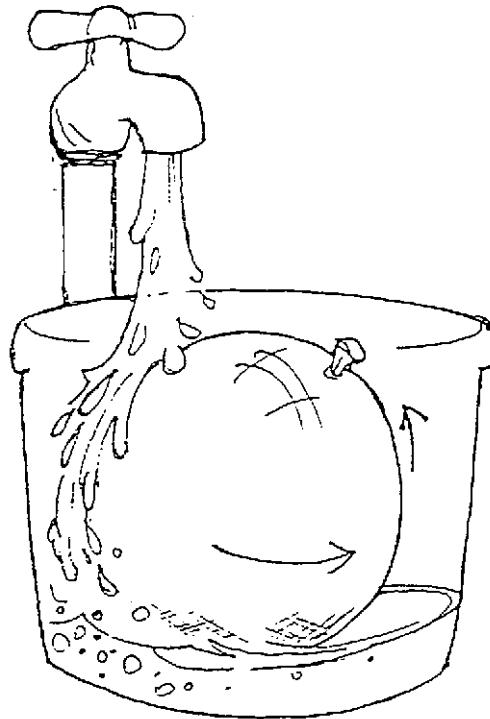

**More to do**

- What happens if the tap is turned on so that more water falls on the balloon. How does the speed or amount of water affect the balloon?
- Find out what energy changes are taking place as the water falls onto the balloon, making it turn like a wheel.
- Design and build other types of water wheels. How can you make a water wheel which will do some useful work?

## STEP ACTIVITY

# Swimming fish

Contributed by Yunus Sola, UK

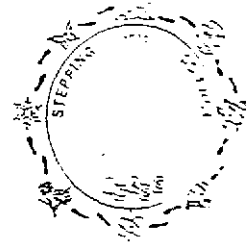

**Challenge:** How can you make a paper fish swim?

### What you need

- paper or cardboard
- large shallow container
- scissors
- cooking oil or detergent
- dropper

### What to do

Draw a fish like the one on this page. Cut it out, then carefully float it on its side in the middle of a large dish or plate of water. Don't let the top of the fish get wet. Using the dropper, put 1 or 2 drops of cooking oil into the hole cut out of the fish. Try not to splash the oil on the fish. What happens to the fish?

Repeat this activity a few times. Each time, start with some clean water.

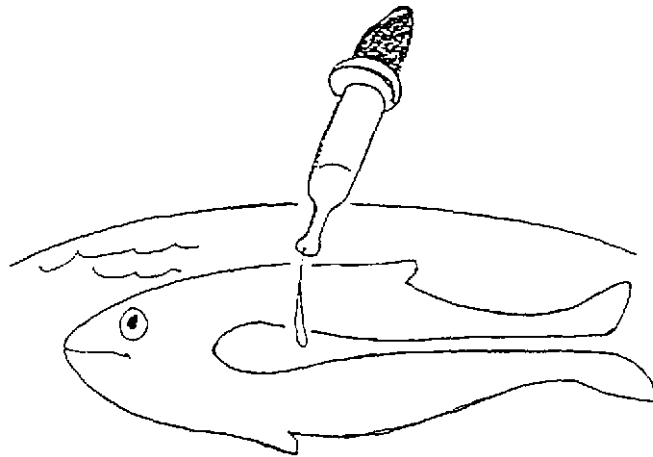

### More to do

- What else besides cooking oil has this effect on the fish? Try detergent, milk and other liquids to see whether they make the fish move forwards. Does it work in warm water, or in cold water? What happens if you add substances like salt or sugar?
- Design other floating objects which move in the same way. Try boats and other things with different shapes. Does the shape make any difference to the speed it moves?

## STEP ACTIVITY

# Bubbles

Contributed by CESI, USA

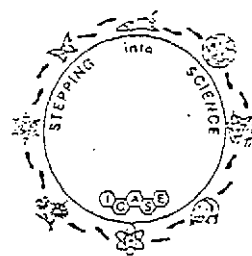

## Challenge: How can you make large bubbles?

### What you need

- liquid detergent
- glycerine
- water
- straws
- string
- scissors
- large shallow dish or frying pan

### What to do

To make bubble solution, mix a quarter cup of liquid detergent and a quarter cup of glycerine with two cups of water. Mix well. This bubble solution can be stored in a jar. Pour some bubble solution into a large shallow dish, such as a frying pan.

To make a bubble frame which makes big bubbles, you will need two straws and some string.

Use the straws to form two sides of the square frame. Pass the string through the straws and tie a knot to complete the square. Tuck the knot into the end of one of the straws. Lower the frame into the large dish of bubble solution. Lift up the frame. What do you see? The frame has a large square bubble film attached to the straws and string. What happens when you move the straws? The bubble film moves too. Hold the frame up and blow towards the bubble film. Can you make a large bubble by blowing into the frame?

### More to do

- Use the frame to investigate which bubble solutions last longer. Try bubble solutions with less detergent, more detergent, no glycerine, more glycerine. Try adding other substances such as sugar to detergent solution.
- Cool the bubble mixture in a refrigerator. Does cold bubble mixture last longer?
- Design different bubble frames to make bubbles of various shapes.

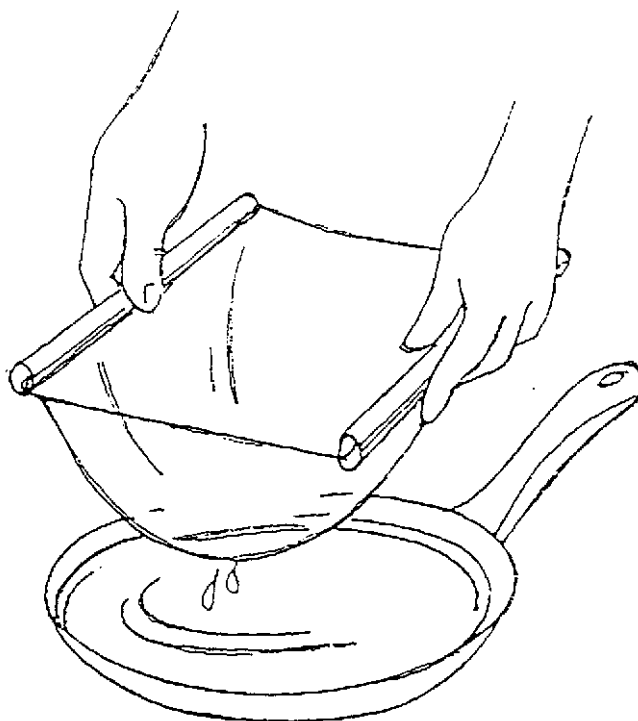

STEP ACTIVITY

# Soils and water absorption

Contributed by S P Ariyawathie, Sri Lanka



**Challenge:** How can you measure the amount of water absorbed by different soils?

## What you need

- different soil samples
- 2 measuring jugs (one could be a syringe)
- absorbent paper such as newspaper or kitchen paper towel

## What to do

Measure identical sample amounts of soil. Place each sample on an absorbent piece of paper – these should be the same type and size. Add the same amount of water to each soil sample and observe what happens. Measure the area of dampness around each mound of soil.

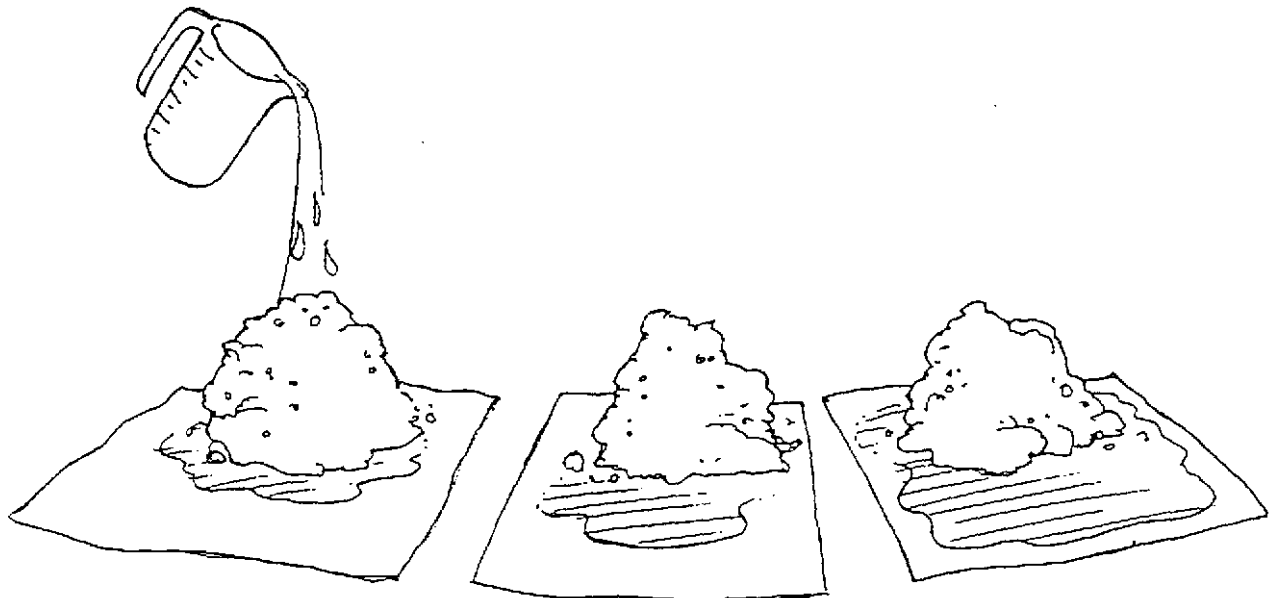

## More to do

- How can you make the soil hold more water? Design and test your ideas. Why is this knowledge important?



## STEP ACTIVITY

# Floating a straw

Contributed by CESI, USA

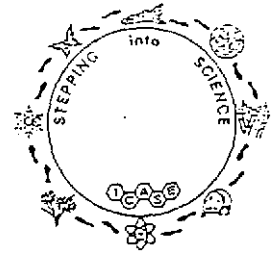

**Challenge:** How can you make a straw float upright in water?

### What you need

- small funnel
- silver sand
- hot water and iced water
- marker pen/crayon
- see-through container
- plasticine

### What to do

Half fill the container with tap water. Seal one end of the straw with plasticine then add some sand through the unsealed end of the straw. Test the straw to see if it floats. Add or remove sand until the straw just floats upright. Mark the water level on the straw.

Remove the straw from the tap water. Remove half the water and replace it with hot water. Put the straw back in the hot water and watch what happens. Mark the water level on the straw.

Repeat this test with iced water. Does the straw float?

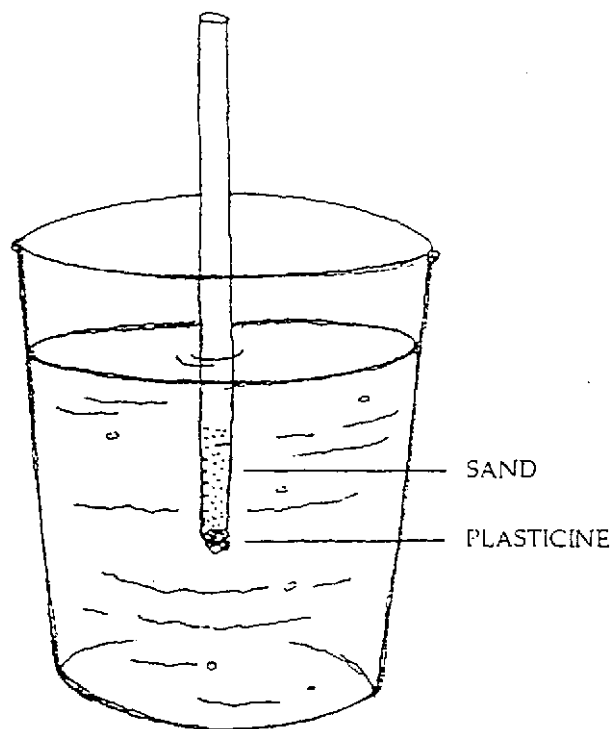

### More to do

- Try water from a lake, a river, or the sea. Does the straw float in water from these places?
- Add sugar to water. Does the straw float in sugary water? Try adding other substances such as salt. Does the straw float?

## STEP ACTIVITY

# Cartesian diver

Contributed by Yunus Sola, UK

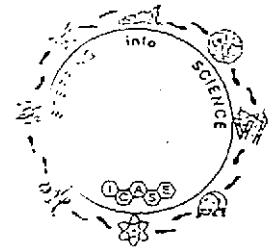

**Challenge:** How can you make a 'diver' dive and rise in a bottle?

### What you need

- large plastic bottle and cap
- pen lid or dropper
- plasticine
- water

### What to do

Fill the plastic bottle with water. The pen lid becomes the 'diver' by putting it into the bottle so that some air is trapped inside. You can see this in the diagram. Stick enough plasticine on the bottom of the pen lid so that it just floats. If using a dropper as a diver, you may not need plasticine – squeeze out enough air so that the dropper just floats.

Put the cap on the bottle. Squeeze the bottle. What happens? Let go of the bottle. What happens? Can you make the diver stay half way down the bottle?

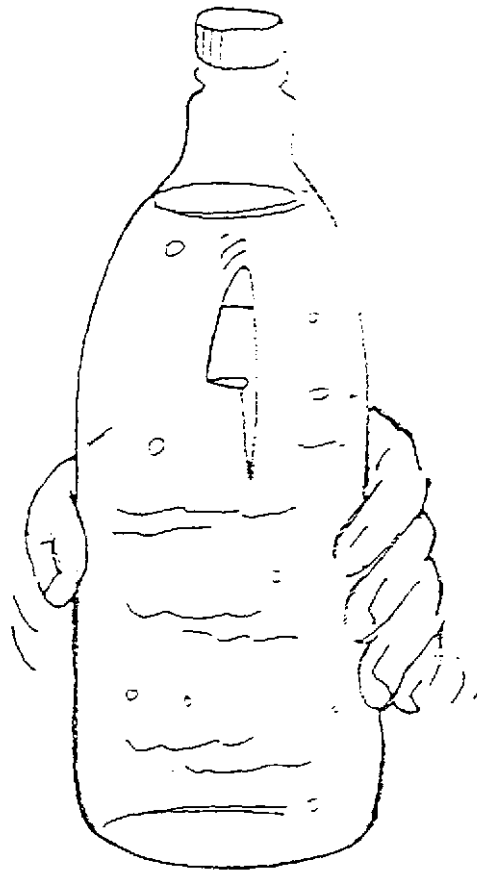

### More to do

- Try making the diver rise and sink slowly or quickly.
- Do certain types of bottles work better than others?
- Can you use other things as divers?
- What happens if you use liquids other than water? Try cooking oil, sea water, and other liquids. What happens if you add sugar, salt or other substances to water?

STEP ACTIVITY

# Dancing spaghetti

Contributed by Karen Heizer, USA

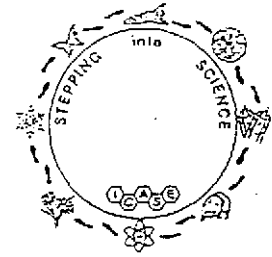

**Challenge:** How can you make spaghetti dance?

What you need

- clear glass jar or plastic container
- dry spaghetti broken into short pieces
- vinegar
- bicarb soda (sodium bicarbonate)

What to do

Almost fill the jar or container with water. Add a teaspoon of bicarb soda and stir until it has dissolved. Add the small pieces of spaghetti. Finally, add a little vinegar. What happens? What do you see happening to the small pieces of spaghetti?

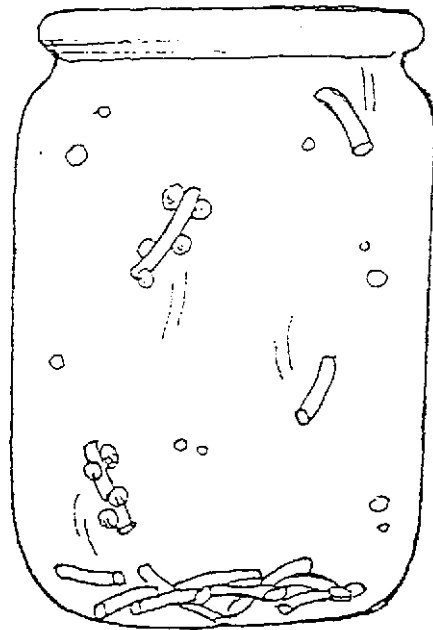

More to do

- What can you do to make the spaghetti go up and down more quickly? Try different amounts of bicarb soda and vinegar. Try water which is cooler or warmer. .
- Try different types of and shapes of spaghetti. Try sultanas, raisins, moth balls and other objects. Which works better – objects with smooth surfaces or rough surfaces?

STEP ACTIVITY

# Making indicator paper

Contributed by CESI, U.S.A

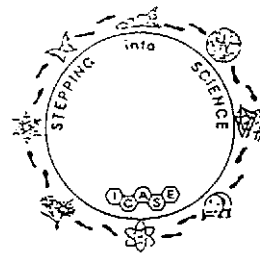

**Challenge:** How do you make indicator paper from cabbage and use it to test if solutions are acid or alkaline?

## What you need

- red cabbage
- pan or pot
- boiling water
- colander or sieve
- filter paper
- scissors
- a variety of acidic and alkaline solutions eg. lemon juice, bleach etc.

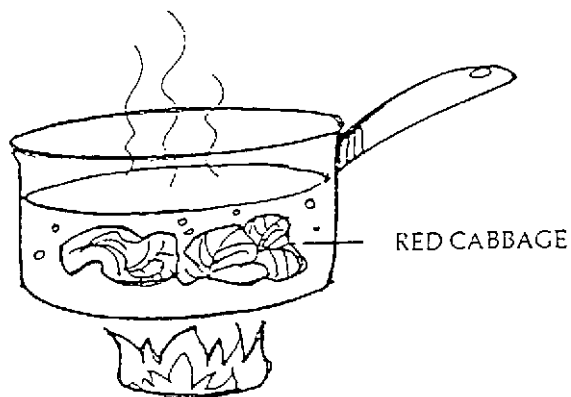

## What to do

Place a small amount of red cabbage in a pot or pan of boiling water. Alternatively, pour some boiling water onto the cabbage and stir. After about ten minutes (or when the water is coloured), drain the cabbage and save the water. Soak the filter paper in the coloured water, then hang to dry.

Cut the paper into strips and place one in each of your solution samples. The strips of indicator paper can be used to test if solutions are acidic or alkaline.

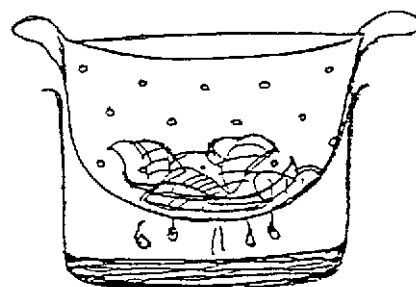

DRAIN AND COLLECT  
CABBAGE WATER

## More to do

- If you have some cabbage water left over try dyeing some material. The cabbage pigment is quite strong, so be careful of fabrics you don't want re-coloured! Remember, different acidic or alkaline solutions will change the dye colour.
- Choose some other plants and see how they work. Follow the steps above and test the alkaline and acidic solutions. Does the paper change colour? Does it still turn red or blue?

## STEP ACTIVITY

# Sifting sieves

Contributed by Maise Southwell, Antigua, WI

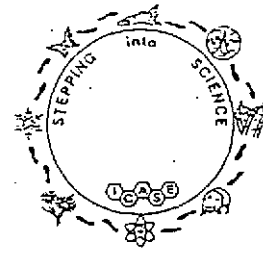

**Challenge:** Can you design and construct a sieve to sift flour?

### What you need

- cardboard
- staples
- sticky tape
- scissors
- ruler
- pencil
- timber
- glue or string
- hacksaw
- bench hook
- pin

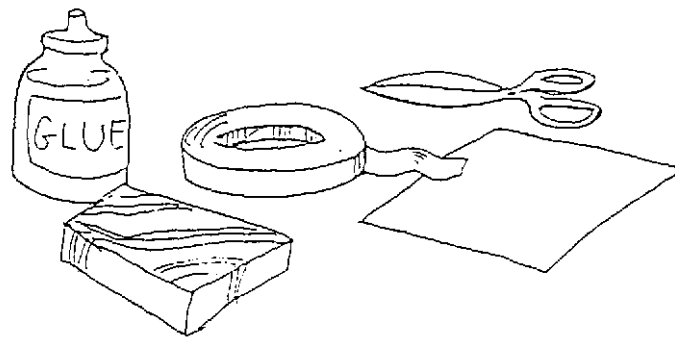

### What to do

Cut the timber and fix together to make a frame. Think about how the sieve is to be held and moved to decide the best shape and method of construction. Use cardboard to make the sieve. Think about how many holes are needed to sift flour. How big should the holes be?

CARD TRIANGLES  
GLUED BOTH SIDES  
OF CORNERS

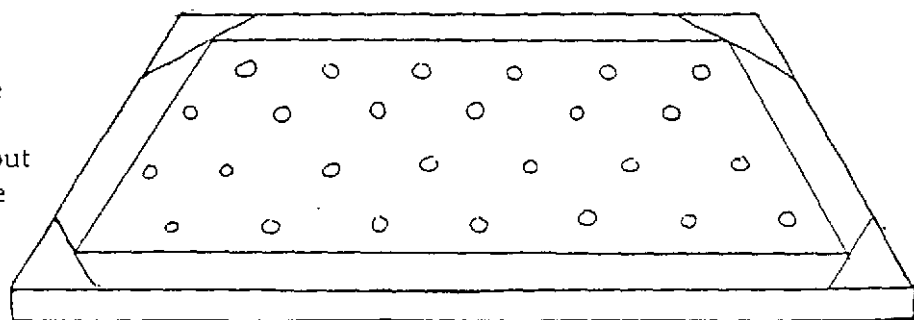

### More to do

- Try using other materials to improve your sieve.
- Experiment with other things your sieve may be able to sift.
- Can you alter your sieve each time you want to sift things of different sizes?
- What other uses does a sieve have?

## STEP ACTIVITY

# Mystery tower

Contributed by Yunus Sola, UK

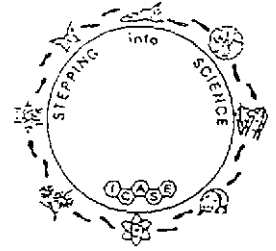

**Challenge:** How can you remove the colour from cola?

### What you need

- cola drink
- fine sand, coarse sand, grit of different sizes
- top half of a plastic bottle with cap
- bottom half of a plastic bottle

### What to do

Pour some cola drink into a glass. What colour does it have? How can we remove this colour? Let's build a mystery tower that can remove the colour from cola.

Make holes in the cap on the top half of a plastic bottle. Turn the top half upside down and rest it on the bottom half of the bottle. First place the large pieces of grit in the top half, then smaller pieces. Then place a layer of coarse sand on top of the layers of grit. Finally place a layer of fine sand on top.

Pour cola into your mystery tower. What happens to the colour of the cola as it moves through the layers, through the cap holes and into the container below.

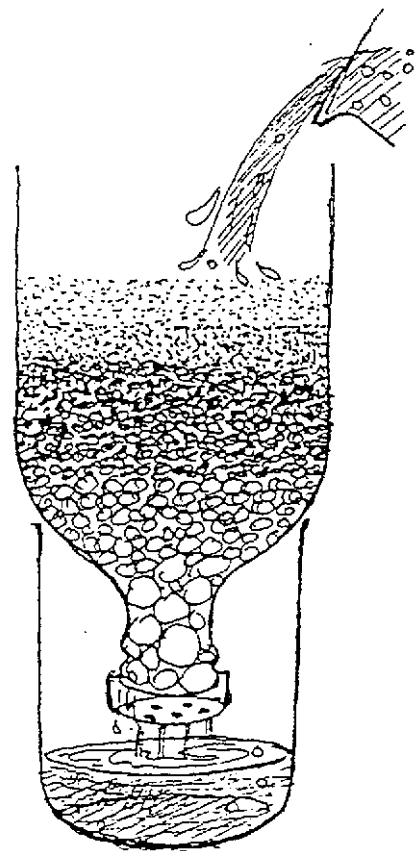

### More to do

- Empty the grains of sand and grit onto a dish. Has their colour changed?
- Try using different substances as the separator, such as charcoal, baking soda and salt. Do these substances remove the colour from cola?

## STEP ACTIVITY

# Whizzer spinners

Contributed by Yvonne Johnson, USA



**Challenge:** What colours can you see when you spin the disk?

### What you need

- white paper
- scissors
- pencil
- needle or pin
- coloured pencils
- string, wool or thread
- 2 buttons

### What to do

Trace or cut out the disk and colour each section with a colour of the spectrum. Glue a button either side of the spinner as shown so that their holes are lined up. Push a pin or needle through the button holes to make holes through the the paper disk. Feed the string through the buttons and knot. Wind the disk as tight as you can, then pull the ends of the string apart to spin the disk. By pulling, then loosening the string, you should be able to keep the disk spinning. What happens to the colours on the spinning disk?

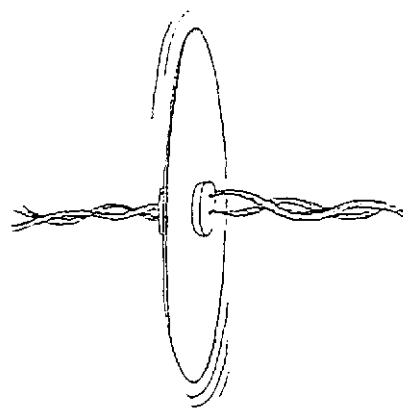
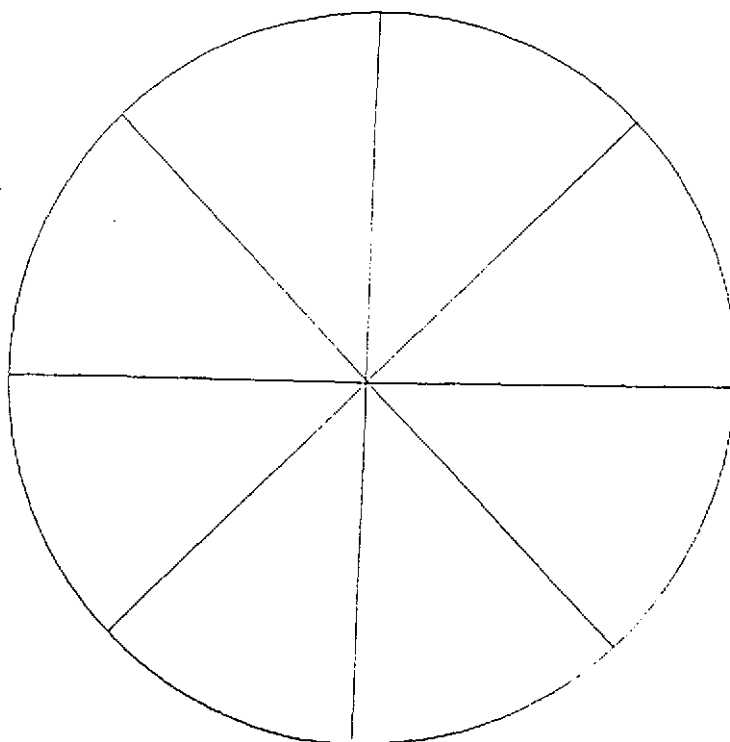

### More to do

- Rearrange the colours on the whizzer disk. Does this change what you see when the disk is spinning?
- Make a whizzer disk using just a few colours. What changes do you see as you spin the disk?

STEP ACTIVITY

# Now you see, now you can't

Contributed by Angela Baker, UK

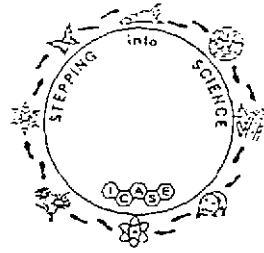

**Challenge:** How can you show light travels in a straight line?

## What you need

- plastic tubes or flexible straws
- mirror

## What to do

Hold the tube straight and look through it at an object. Keep looking as you bend the tube in the middle – you could get a friend to do this for you.

How far can you bend the tube until you no longer see the object?

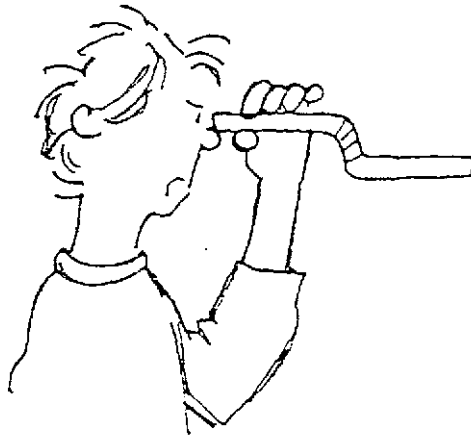
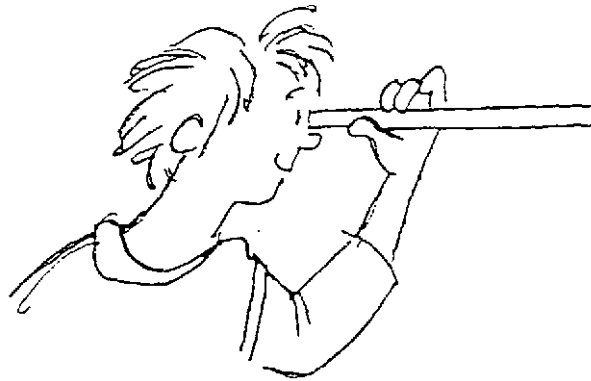

## More to do

- Can you design another simple activity to show light travels in a straight line? Try using some mirrors. Think about how mirrors are used to make light travel around corners!



STEP ACTIVITY

# Hole in your hand

Contributed by Hafiz Muhammad Iqbal, Pakistan

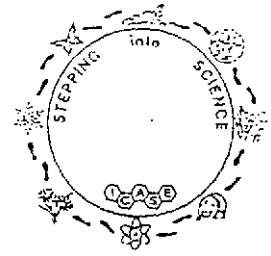

Challenge: How can you make an illusion?

What you need

- paper
- sticky tape

What to do

Roll a piece of paper to make a tube. Fasten with sticky tape at both ends – this will stop it unrolling. Hold the paper close to your right eye and close your left eye. Bring your left hand close to your left eye and then open both eyes. What do you see?

Try slowly moving your left hand along the tube, away from your eye. What happens?

Try this experiment with both eyes open to start with.



More to do

- What other optical illusions (tricks on your eyes) can you find? Make a collection and try them with your family and friends.

STEP ACTIVITY

# Olfactoria

*Contributed by Raphael Douglas, Trinidad*

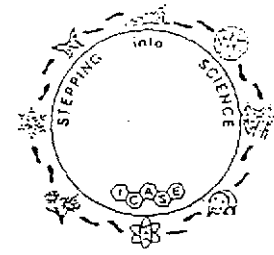

**Challenge:** Can you identify objects by smelling them?

**What you need**

- clean small containers with lids
- substances with different scents

**What to do**

Prepare a collection of smelling jars for your friends or family. Place substances which have different smells inside the containers – lemon slice, garlic, pepper, apple, etc. Make sure that you cannot see through the containers and their lids. Put holes in the lids so you can smell but not see what's inside. Challenge people to guess what's in each container!

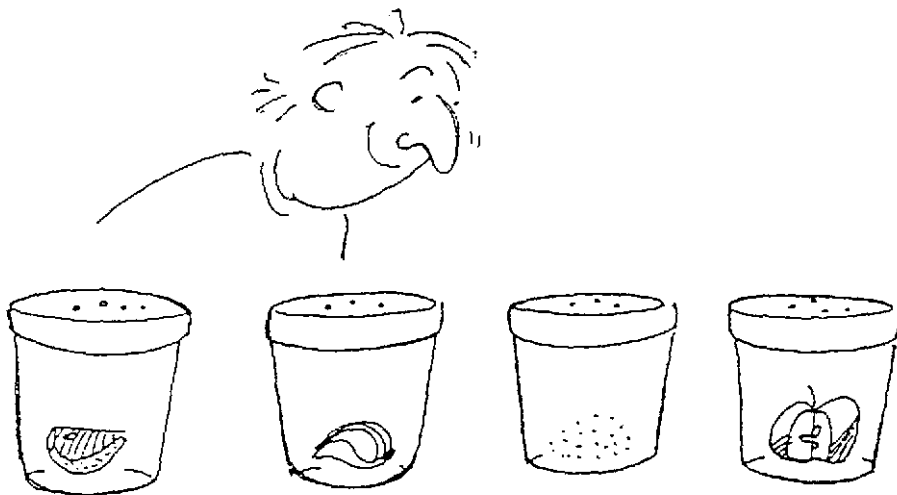

**More to do**

- Design similar investigations using different senses – taste, touch, etc – to guess what things are.

## STEP ACTIVITY

# What's inside my body?

Contributed by Yunus Sola, UK



**Challenge:** Can you locate the position of the main organs in your body?

### What you need

- paper large enough to trace around your body
- dark pen or crayon
- sticky tape

### What to do

Join with two or three other children to do this activity. Make a list of the main organs in your body – this can be done by the whole class so that everyone has the same list. Spread the large piece of paper on the floor and tape down to corners. Ask one person in your group to lie down on the paper and draw around the person. Be careful – don't mark your friend's clothes with the crayon. Once this is done, ask the person to get off the paper.

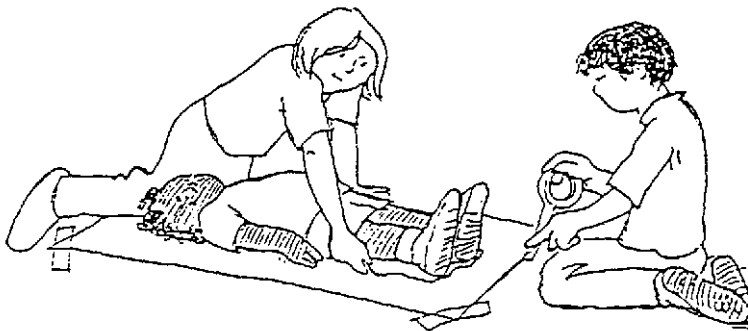

Now discuss where each organ on the list goes. Once you agree, draw the organ in its position on the paper. Write the name of each organ next to its position. When you have finished, tape your diagram up on a wall for other children in the class to see. Compare your drawing with the diagram here.

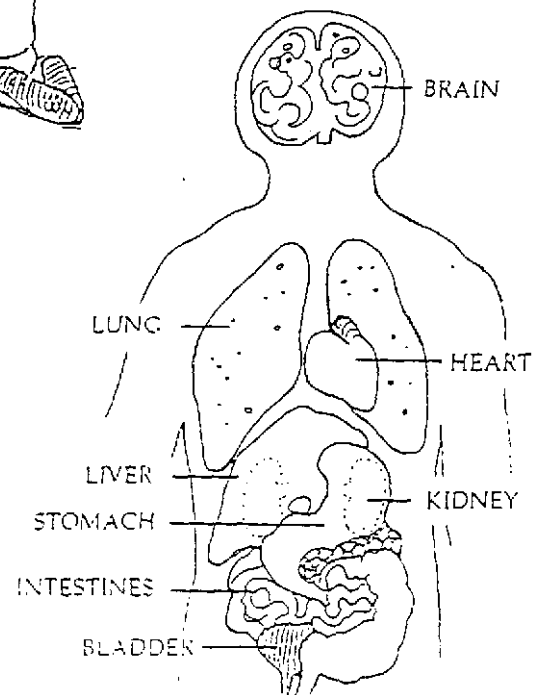

### More to do

- Find out how each main organ works. Why is it important to have each organ?

STEP ACTIVITY

# I'm stuck!

Contributed by Yunus Sola, UK

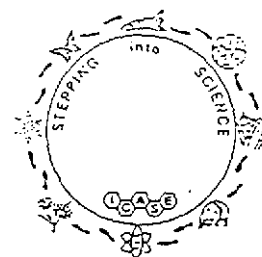

Challenge: Which is the stronger adhesive?

What you need

- sticky tape
- glue
- paper
- wood
- plasticine
- bread
- plastic bags
- weights
- scissors

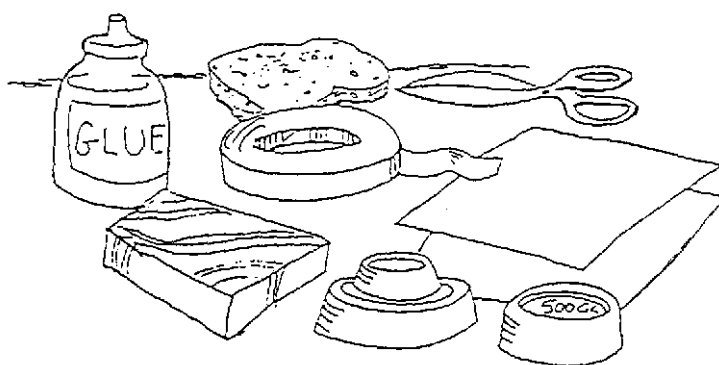

What to do

Choose different things to stick together. Design a test to measure which is strongest – different types of sticky tape, or different types of glue.

Remember to test fairly when you are comparing. This means you must do the same thing with both the glue and the sticky tape.

Keep a record to show the results of each test.

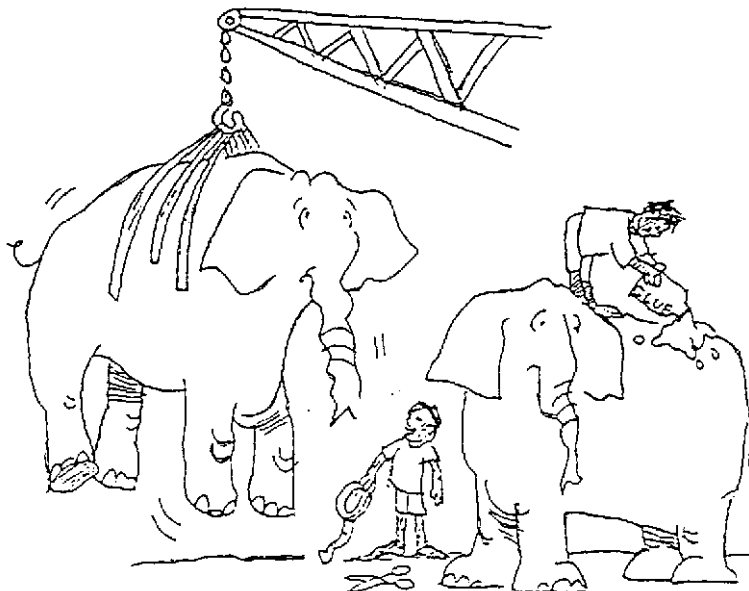

More to do

- Neither glue or sticky tape may stick to some things. Investigate other ways to join these objects.

## STEP ACTIVITY

# My coffee is cold

Contributed by Yunus Sola, UK

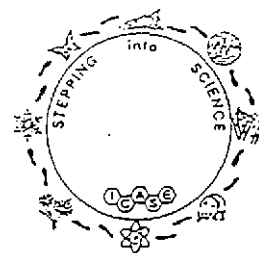

**Challenge:** Can you design a container to keep drinks or food hot for a long time?

### What you need

- plastic cup
- container such as an ice cream container or half a PET bottle
- thermometer
- newspaper
- pieces of cloth
- hot water

### What to do

Try different insulating materials – newspaper, pieces of cloth, etc – to design a container to keep a warm drink from going cold.

Add a certain amount of hot water to a plastic cup for each test. The insulating container should be slightly larger than the cup.

Because you are comparing results remember to keep use the same amount of hot water each time and to place the cup in the same position each time.

Use a thermometer to measure the temperature at regular intervals. What happens to the temperature of the water when using the different insulating materials? Which insulation keeps the cup hot for the longest time? Compare this with the time it takes when there is no insulation?

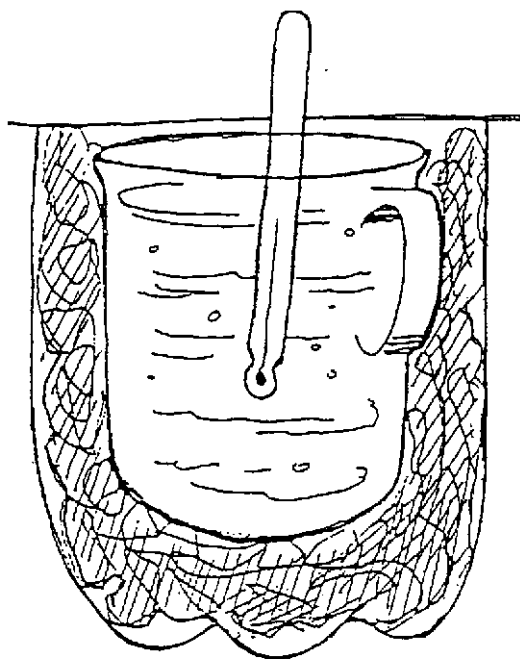

### More to do

- Design a way to find out which insulation material keeps a drink cold for a longer time. Do you need to change the design you used for keeping a drink hot?

## STEP ACTIVITY

# Model greenhouse

*Contributed by Peter Metcalf, Australia*

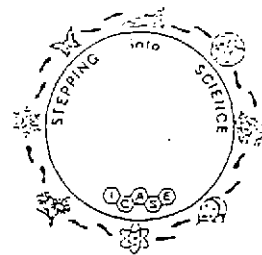

**Challenge:** What happens to the inside of a container when it's put in the sun?

### What you need

- large clear plastic bottle
- a tin painted black
- thermometer
- sunshine

### What to do

Do this activity outdoors on a day when the sun is shining. Put a thermometer in a tin which has been painted black. Measure the temperature. Cut a plastic bottle in half. Cover the tin with the bottom half of the plastic bottle as shown. This is like a greenhouse. Measure the temperature at regular intervals. What happens to the temperature inside the tin? Design a chart to show the temperature change.

If you do not have a thermometer use your hand to compare the temperature of the tin before and after covering with the greenhouse.

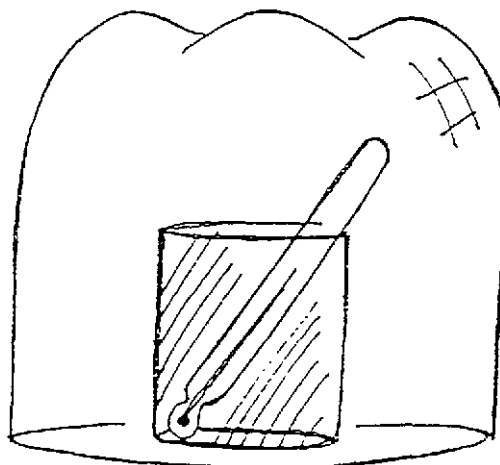

### More to do

- How could you control the rate at which the temperature rises?
- What effect would water in the tin have on the temperature inside the greenhouse?
- How could you design a greenhouse that could retain the heat for a longer period of time?

STEP ACTIVITY

# Magnet sticks

*Contributed by CESI, USA*

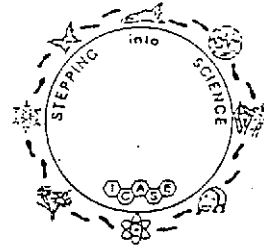

**Challenge:** What type of objects do magnets attract?

## What you need

- lollipop/paddle pop stick
- clear tape or glue
- small magnet
- square or grid paper
- objects to test such as toy car, pebble, clips, nails, screw, coins, cloth, etc.

## What to do

Fix the magnet to one end of the pop stick. Test the magnetism of different objects by holding the pop magnet over them. Which ones are attracted to the magnet? Design a table to record your results.

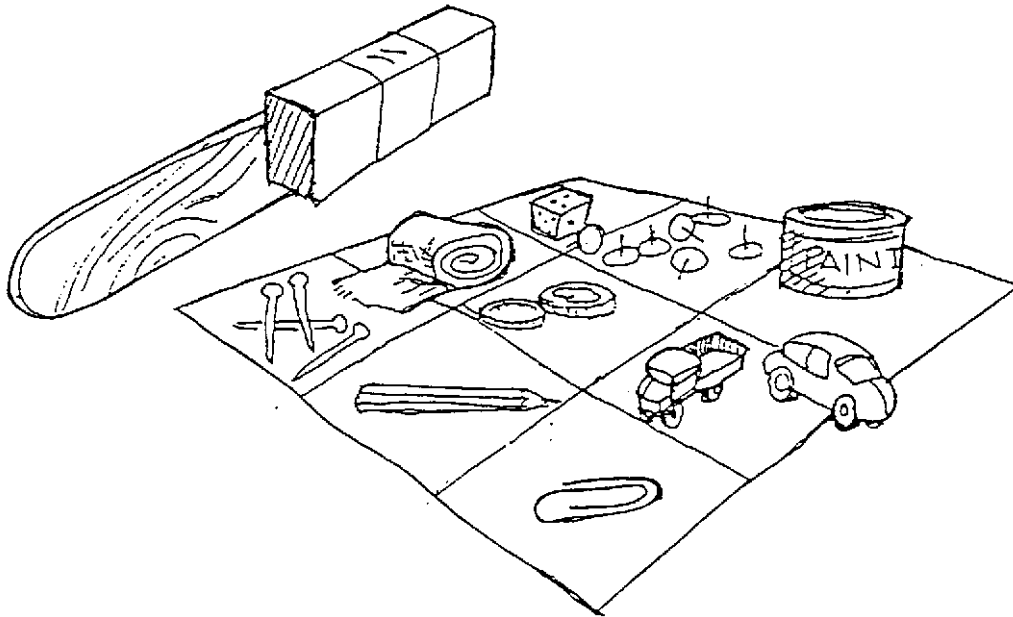

## More to do

- Use your magnet stick to test other objects around the room.
- Can you design a magnetic chain?
- How long does a magnetised object remain magnetic?

STEP ACTIVITY

# Feast for ants

Contributed by SLASME, Sri Lanka

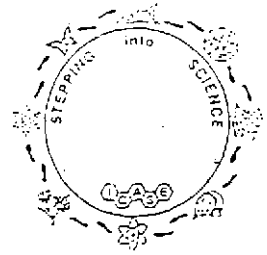

## Challenge: Which foods attract ants?

### What you need

- sugar, salt, chilli powder, dried fish
- paper
- shallow dishes or saucers
- timer

### What to do

Put small equal amounts of food in dishes. Place the dishes in a row near some ants. Observe the trail of ants as you start the investigation and about 15 minutes later. Which foods attract most ants?

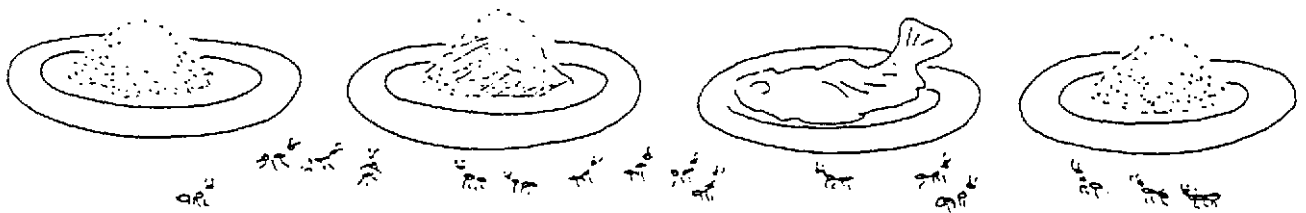

### More to do

- Observe the path of the ants when you change the order of the dishes.
- Work with some friends to count and record the number of ants that visit each food. It may help to have one person count for one minute, then another person for the next minute, and so on.
- Investigate whether the time of day affects what the ants prefer to eat.
- Wet the food. Does this make any difference?



STEP ACTIVITY

# Animal colours

*Contributed by Sue Dale Tunnicliffe, UK*

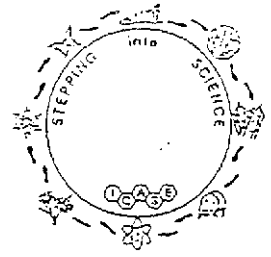

**Challenge:** What colours can you find in animals?

**What you need**

- variety of different coloured cards with the colour name on the back
- pictures of different coloured animals

**What to do**

Place the pictures of animals around the room. Collect one or two colour cards. How many animals can you find with a body colour the same as your cards?

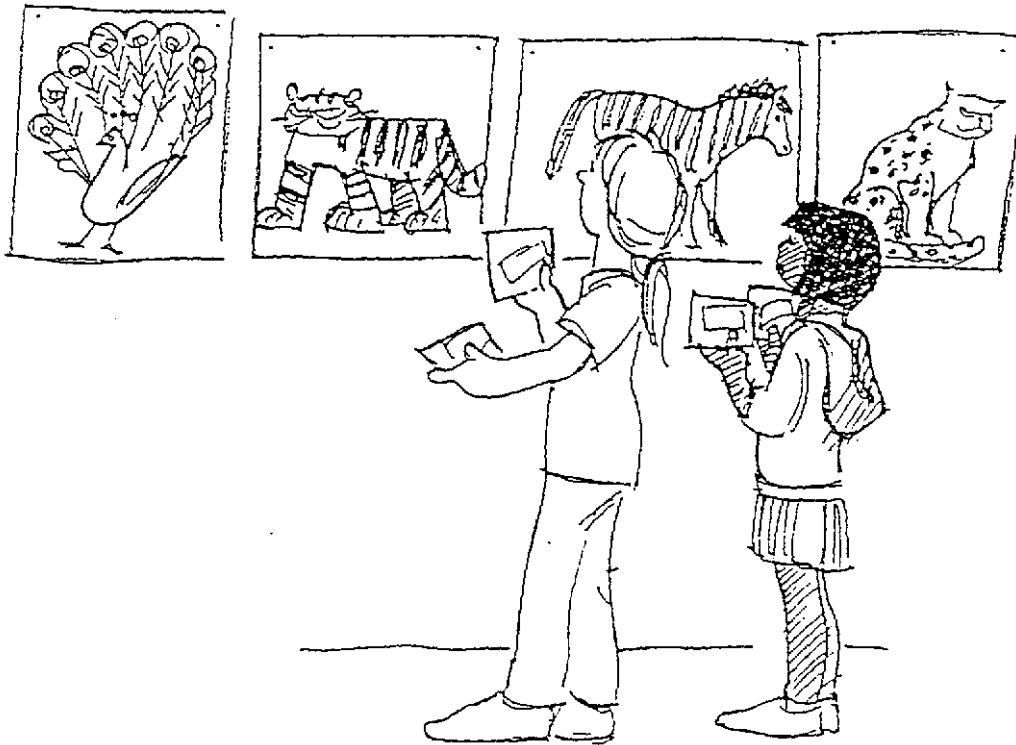

**More to do**

- Using the cards as colour guides, how many different animal colours can you find?
- Find examples of animals using their colours to help them survive.
- Arrange a trip to a zoo or an animal collection in a museum. Use the cards to search for animals with certain colours.

STEP ACTIVITY

# Animal patterns

Contributed by Sue Dale Tunnicliffe, UK

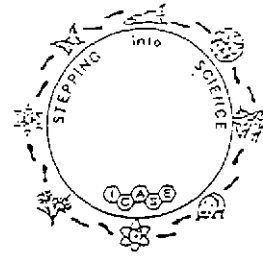

**Challenge:** What patterns can you find on animals?

**What you need**

- variety of different patterned cards with pattern name on the back
- pictures of animals with different patterns

**What to do**

Place the pictures of animals around the room. Collect one or two pattern cards. How many animals can you find with a pattern the same as your cards?

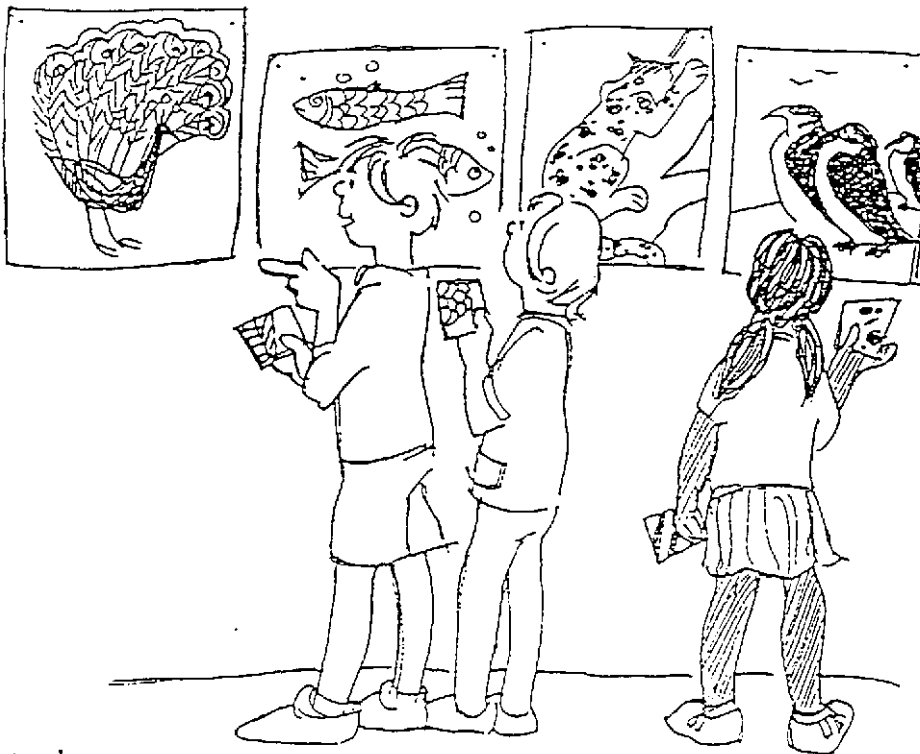

**More to do**

- Using the cards as pattern guides, how many different animal patterns can you find?
- Find examples of animals using their patterns to help them survive.
- Arrange a trip to a zoo or an animal collection in a museum. Use the pattern cards to search for animals with certain patterns.

STEP ACTIVITY

# Where do legs go?

Contributed by Sue Dale Tunnicliffe, UK

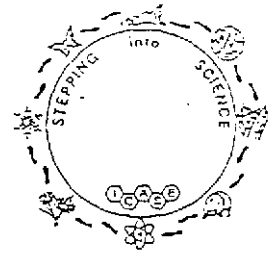

Challenge: Where is the best place for legs?

What you need

- corks, plasticine or playdough for animal bodies
- toothpicks or matchsticks for legs
- stiff cardboard

What to do

Using corks or some plasticine or playdough, design a four legged animal's body and attach toothpicks or matchsticks as its legs. Make a similar body, but change the position of the legs.

Make a two legged body and support it with two legs so that it stands upright. You may have to make some feet using plasticine or playdough.

Put all the animals on the stiff card and wobble them. What happens?

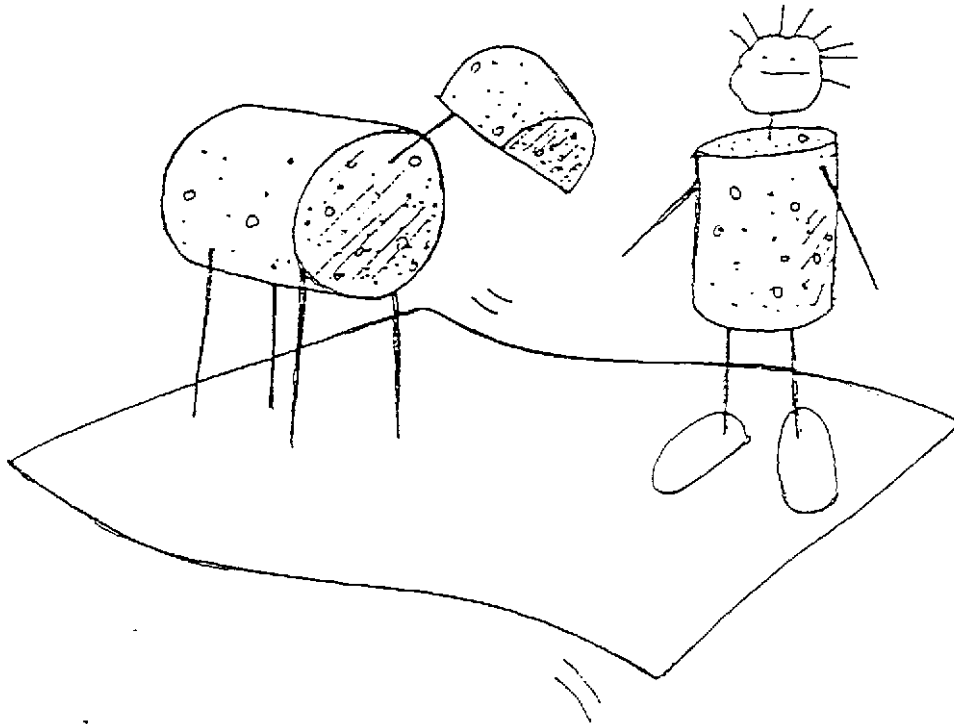

More to do

- Can you alter the position of the legs so that the bodies are more stable (so that they do not fall over easily)?
- How does the type of body determine the number of legs and their position on a body?

STEP ACTIVITY

# How big is a whale?

Contributed by Cynthia Clark, USA

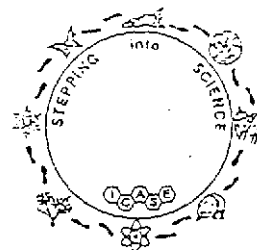

Challenge: How can you show how big a whale is?

## What you need

- metre stick
- chalk
- whale grid sheet below
- a space 21 metres long and 9 metres wide

## What to do

Use the grid below to help you draw a whale 21 metres long! Choose a large area in the playground. You will need a space 21 metres long and 9 metres wide. Using chalk, a stick or a pebble, mark out a grid in the playground as follows. Draw a line 21 metres long and put a mark every 3 metres. Measure 3 metres above and below the line and draw 3 metre squares to complete a full size grid seven squares long and two squares wide. Draw the whale on the full size grid using the diagram on the small grid as a guide. Now you can see how big a whale is!

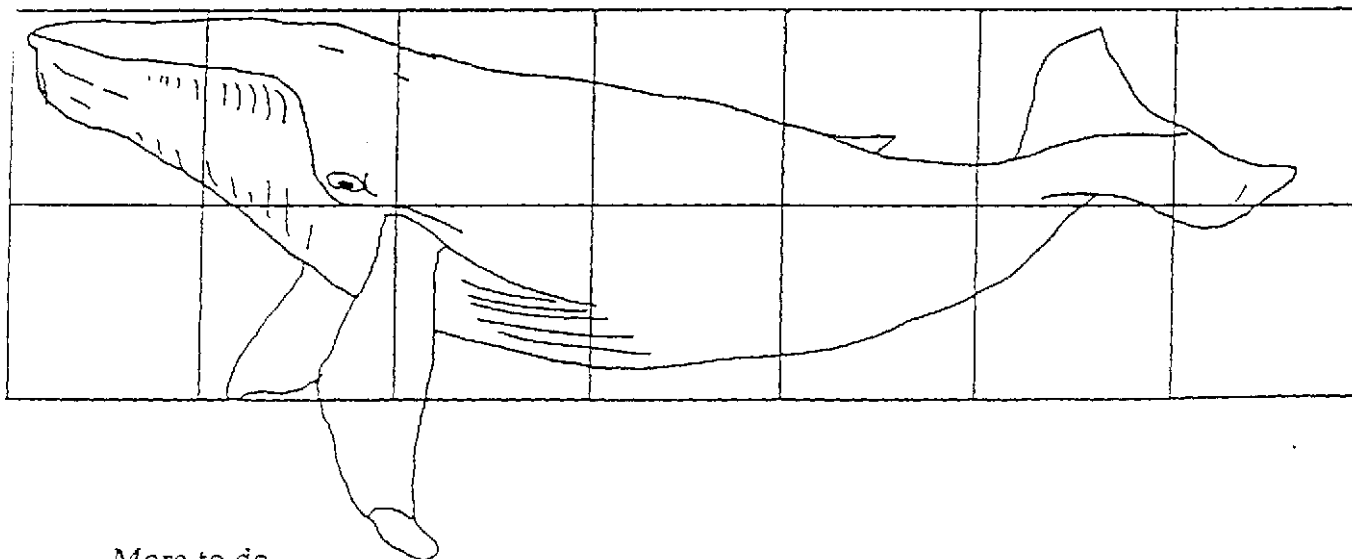

## More to do

- Display a sign with information about sperm whales.
- What is your favourite meal? How many meals would it take to equal the weight of a sperm whale? A sperm whale can weigh up to 60,000 kg!
- Adopt a whale. In the USA you can write to: International Wildlife Coalition, 634 N. Falmouth Highway, PO Box 388, N. Falmouth, MA 02556 USA.

STEP ACTIVITY

# Drawing animals

*Contributed by Yunus Sola, UK*

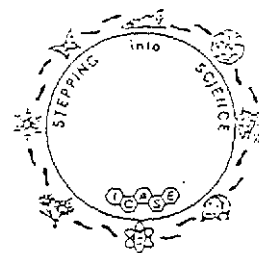

**Challenge:** How well can you draw an animal by listening to a description?

## What you need

- descriptions of animals
- paper
- pencil

## What to do

For this activity, one person reads a description of an animal. As you listen to the description, try and draw the animal. Here is a sample description:

It has teeth which allow it to eat both meat and plants. Its body is covered in hair. It can crawl on its four limbs or stand on two when it wants to. It can run and climb trees. It lives on land and cannot live in water. It usually lives in large groups but sometimes prefers to live alone away from others. Both parents usually look after their young. It makes homes from whatever materials are available. It can hunt and is sometimes hunted.



## More to do

- Instead of drawing the animal, obtain some materials – plasticine, paddlepop sticks, etc – and build a model of the animal as you listen to its description.
- Read a number of different descriptions. Decide which one you would like to draw or build. Display your drawing or model so that other children can see.
- Find out more about the animal that you have drawn or built. Is it similar to any other animals?

STEP ACTIVITY

# Nature trail

Contributed by Yunus Sola, UK

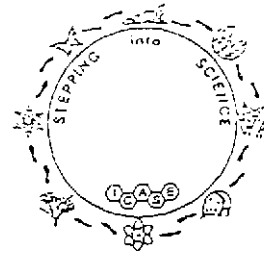

Challenge: What living things can we find around us?

## What you need

- paper
- pen or pencil
- ruler

## What to do

Choose a safe place around your home or school to search for living things. Make a list of what you find – if you don't know the name of something, make a sketch and find out its name later. Design a way of recording your findings to share with others.

Compare your findings with what others have discovered.

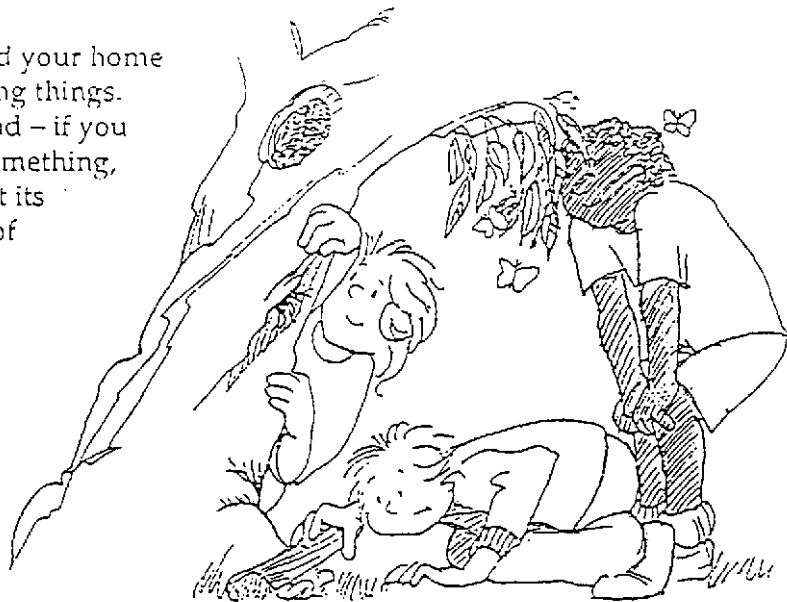

## More to do

- Record what happens in your living systems over a period of time. What changes occur? Why? What can you do to protect the living things near your home or school yard?
- Compare the living systems in your school to those near your home. What differences do you see?

STEP ACTIVITY

# Leaf pollution

*Contributed by Sujatha Dharmaratne, Sri Lanka*

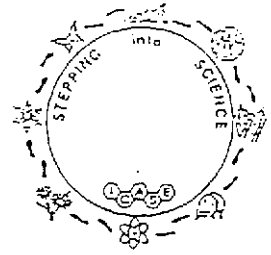

**Challenge:** How do things in the air affect leaves?

## What you need

- living plant with large leaves
- polythene bag
- string
- swab of cotton wool
- hand lens

## What to do

Choose a plant with large leaves. Select two leaves at about the same position on the plant and with similar shapes. Examine closely the surface of both leaves, then wipe them both clean with water and a cotton wool swab. Cover one leaf with a polythene bag and tie it on – leave plenty of air in the bag to allow it to 'breathe'. You may want to use a pin to make vary small holes in the bag. Leave the second leaf uncovered.

Use a hand lens to examine closely the surfaces of both leaves at regular intervals. Using clean water and a cotton swab, wipe each leaf. What do you observe? Record your observations and identify any pollution source nearby such as a factory, road, etc.



## More to do

- Try this activity using different types of leaves in different places.

STEP ACTIVITY

# Dramatic seeds

Contributed by Saroja Abeyathunge, Sri Lanka

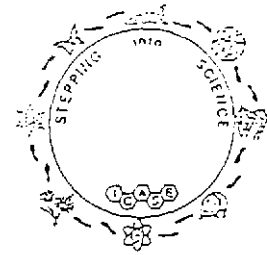

Challenge: How can you use drama to show the growth of seeds?

## What you need

- a story line
- costumes
- stage props

## What to do

Develop a story line, with some friends, for your drama presentation. Here is one developed by some children in Sri Lanka.

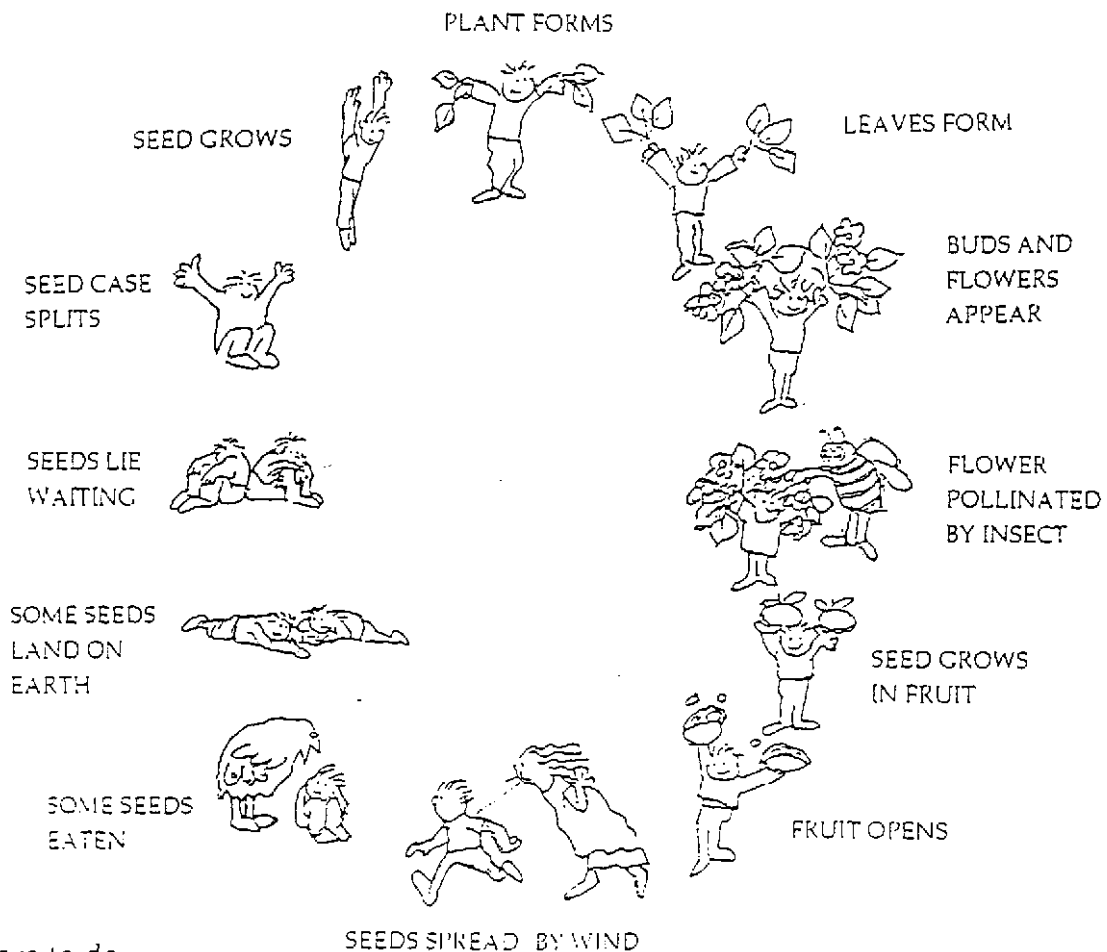

## More to do

- Find some music that suits your topic. Use it for singing or dancing or as background music.
- Design simple costumes and props to represent various parts of the story.



## STEP ACTIVITY

# Measuring trees

*Contributed by Alan Warner, UK*

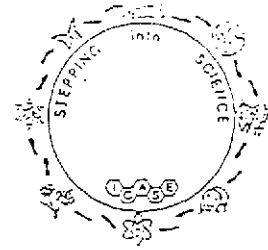

## Challenge: How can you measure a very tall tree?

### What you need

- tree
- string
- ruler
- two metre stick with cm markings

### What to do

Choose a tree. Start next to the tree trunk and walk 18 metres away. Ask someone to hold the measuring stick at this spot. Walk away another 2 metres. Lie down on the ground with your head at this spot. Look towards the top of the tree. Ask the person holding the stick to move a hand along the stick until the thumb is exactly in line with the top of the tree, as the diagram shows.

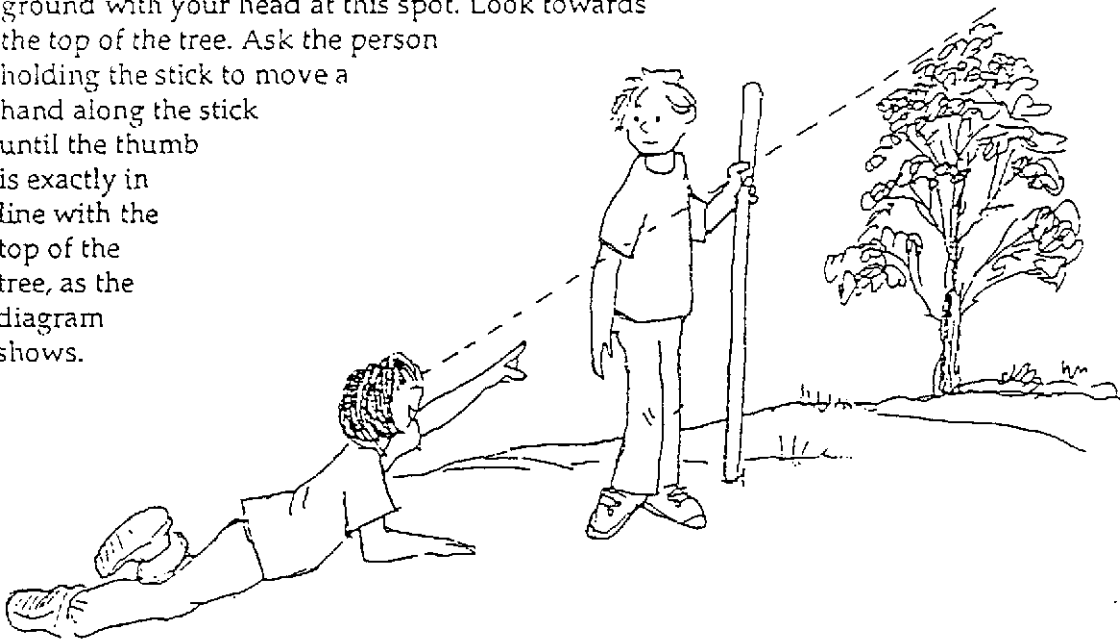

The person holding the stick then records the reading where the thumb is. Calculate how high the tree is in this way – the tree is 10 times higher than the reading on the stick. For example, if the stick reading is 1.5 metres, then the tree is 15 metres high.

### More to do

- Measure the circumference of the tree trunk – a good way to do this is to use some string. Do tall trees have a larger circumference? Measure the circumferences and heights of a number of trees to find out.
- Can you design other ways to measure the height of trees. Could you use these methods to measure the height of tall buildings?
- Find out what factors affect the growth of trees.

STEP ACTIVITY

# Cup planetarium

Contributed by Becky Ruby and Dorothy Pace, USA

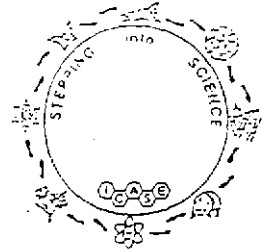

Challenge: How can you show star constellations in a room?

## What you need

- plastic cups (not clear)
- drawing pin
- torch
- constellation patterns
- elastic band

## What to do

Cut out a constellation pattern and place it on the outside base of a plastic cup – you may need to hold it on with a rubber band. Make a hole through each star with a drawing pin. Make sure it goes through the paper and the base of the plastic cup. Remove the pattern and place a torch inside the cup. Darken the room and project the constellation onto the ceiling. Use more cups to make and project other constellations. There are 12 constellation patterns on the next two pages.

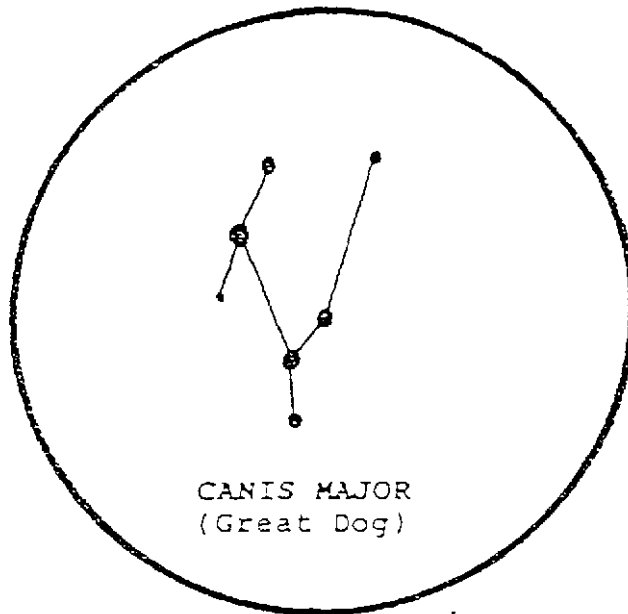

## More to do

- Choose a clear night and see if you can identify some of these constellations.
- Over several nights observe the movement of the constellations.
- Design other ways to demonstrate the constellations inside a room.

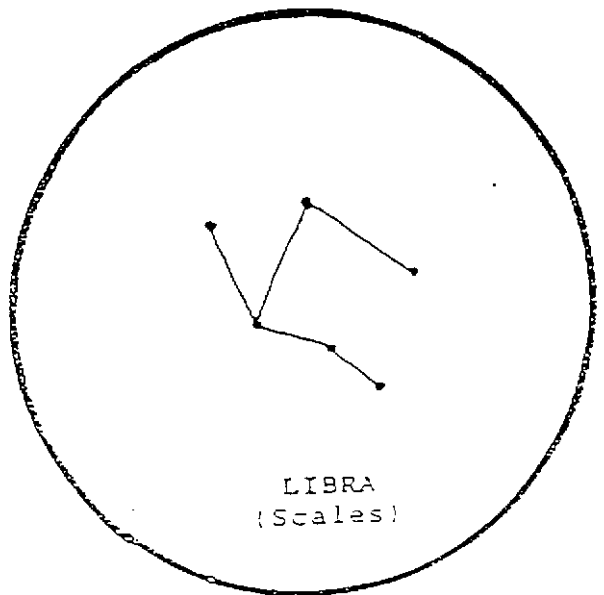
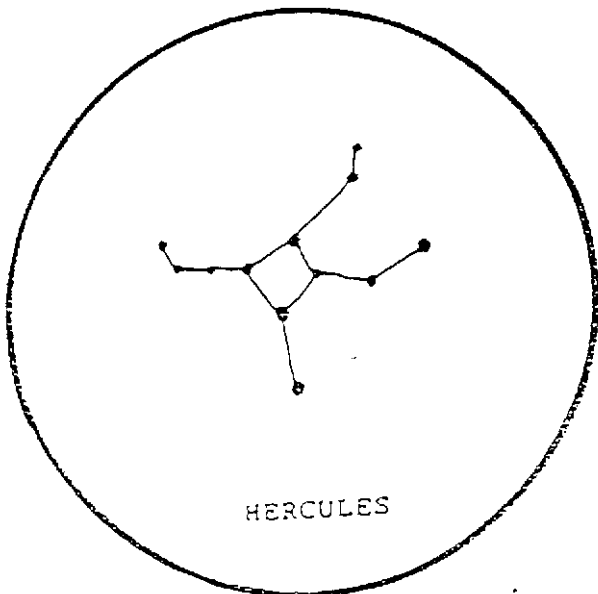
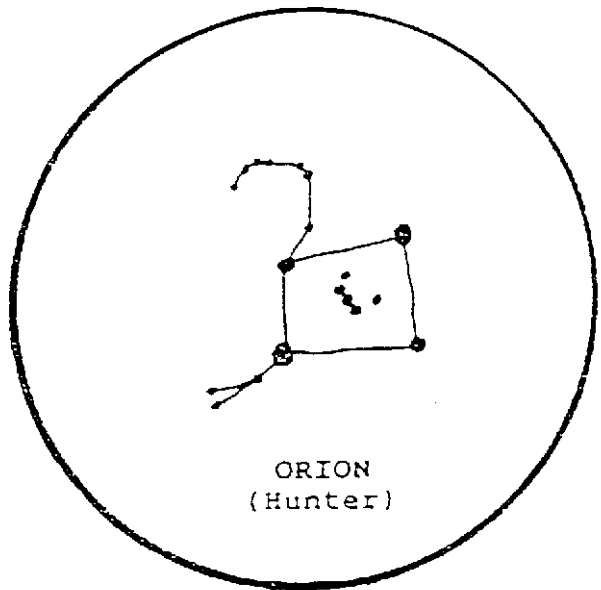
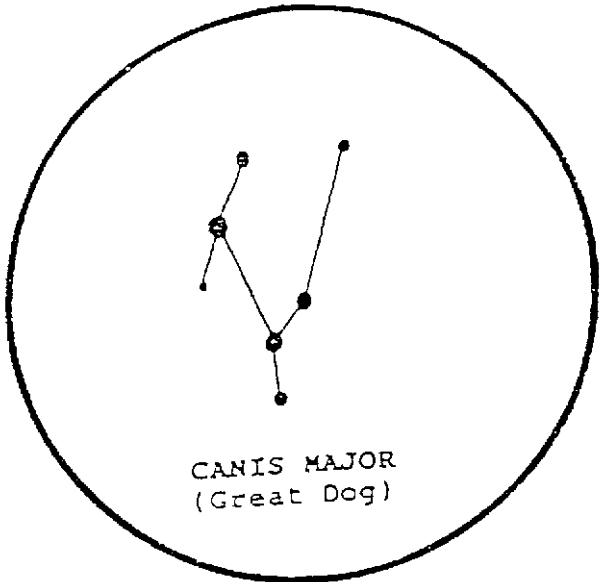
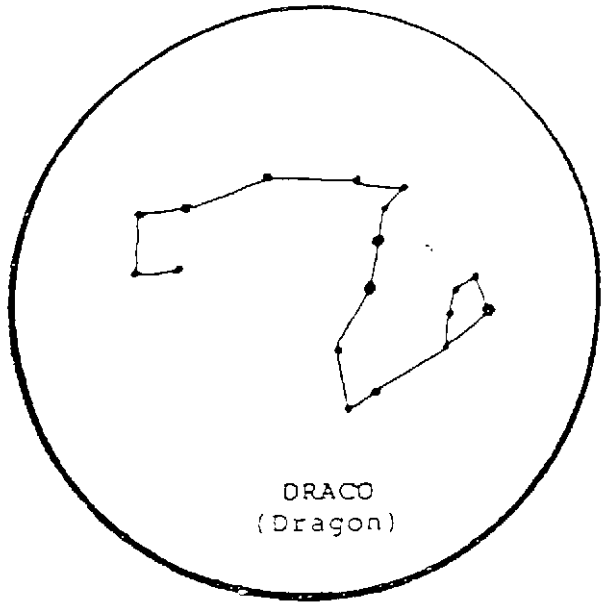
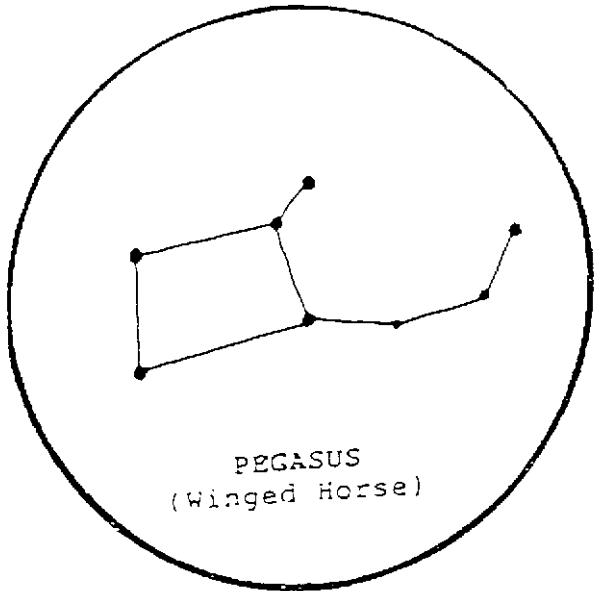

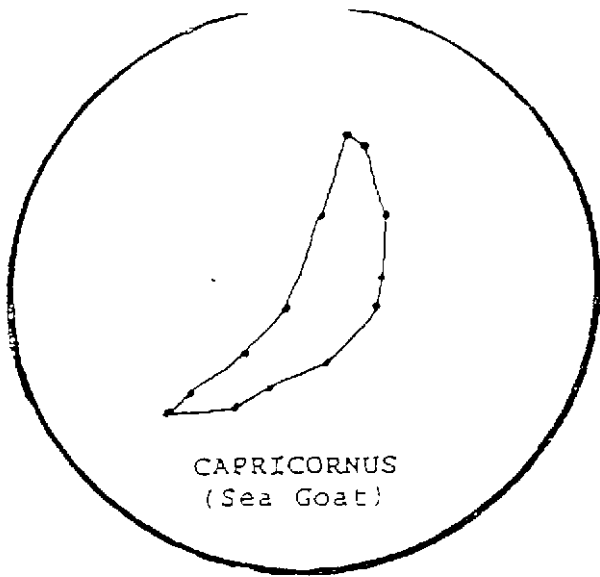

CAPRICORNUS  
(Sea Goat)

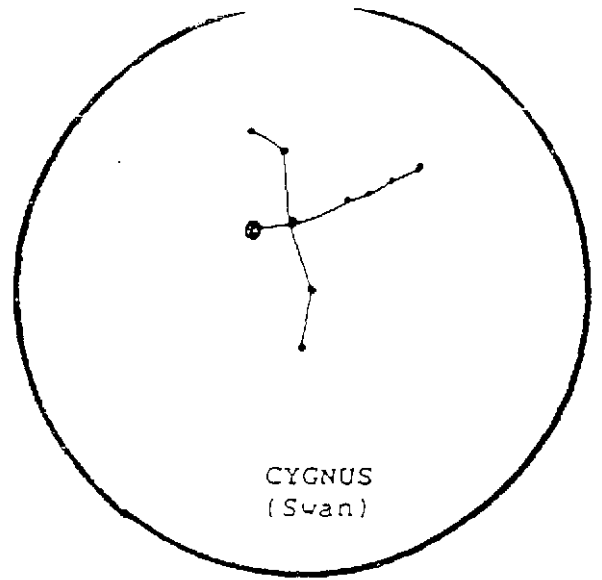

CYGNUS  
(Swan)

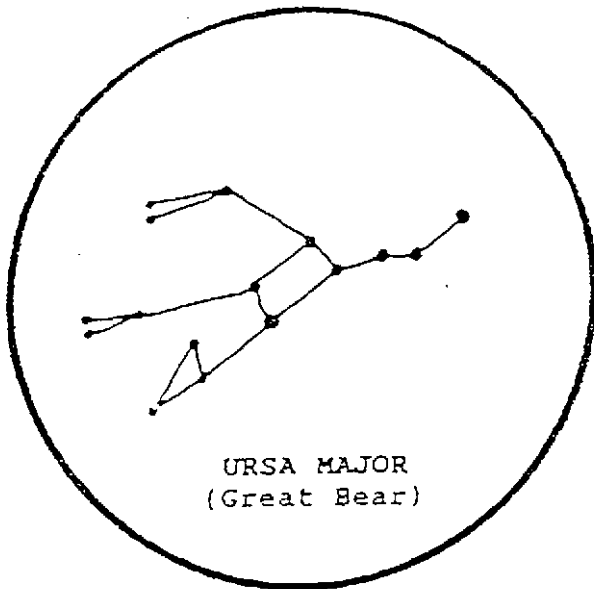

URSA MAJOR  
(Great Bear)

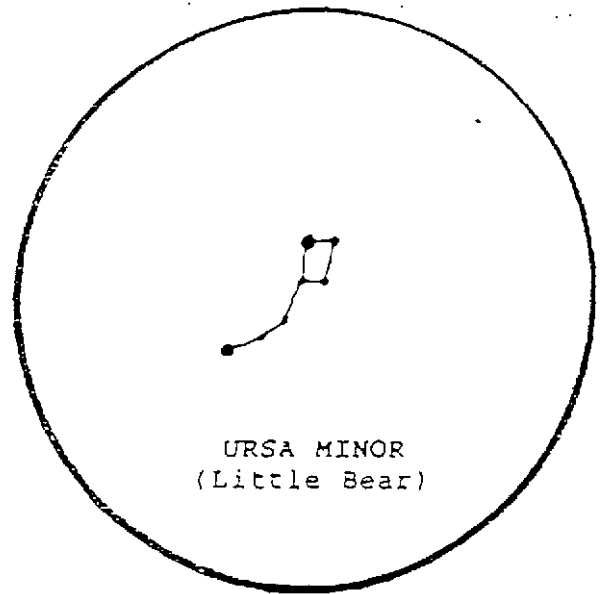

URSA MINOR  
(Little Bear)

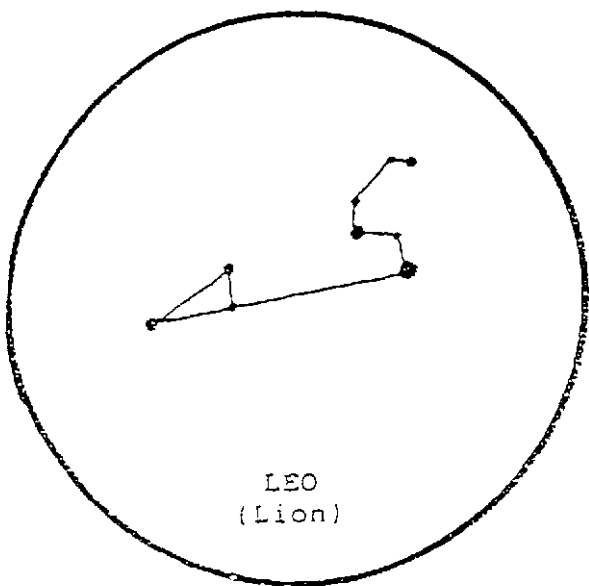

LEO  
(Lion)

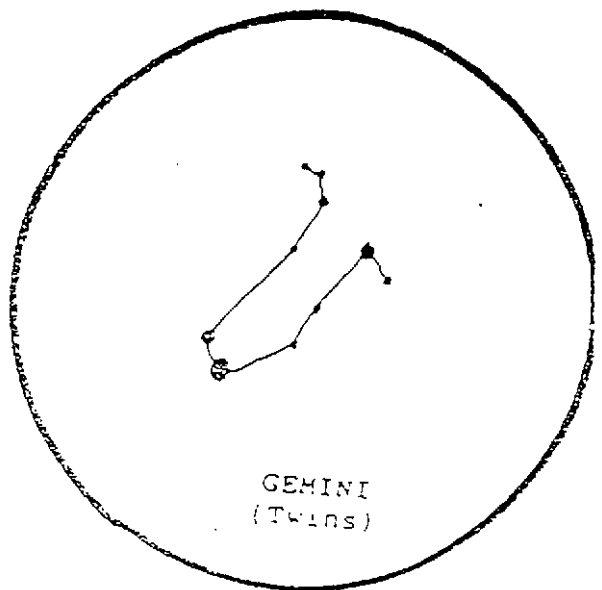

GEMINI  
(TWINS)

## What's going on?

This section provides useful explanations and ideas when discussing what happens as children do the activities. First listen to the ideas of children as they experience the activities. Rather than just tell them answers, discuss these explanations and ideas so that they help children to build on their present understanding.

### Page 1: Charged up science

As the cling wrap is rubbed, very small electrical charges move from the cloth onto the plastic. These charges stay on the plastic to make *static* electricity. The grains of puffed rice are attracted towards the charged surface of the cling wrap. Can you explain what energy transfers are taking place?

### Page 2: Dancing salt

The sound waves from the tuning fork travel through the air to the stretched rubber balloon. The sound waves have enough energy to make the rubber surface vibrate. The vibrating rubber balloon makes the salt jump about. If the tuning fork is moved further away, the salt does not dance about. The energy of the sound waves reaching the balloon becomes less as it travels further. What energy transfers are taking place?

### Page 3: Secret sound box

Sound travels in the form of vibrations. The ticking sound travels from the clock to the sides of the box which vibrate a little. The small vibrations of the box cause the air inside the tube to vibrate. The vibrating air carries the sound of the ticking clock along the tube to your ear. A doctor uses a stethoscope in much the same way to listen to heart and lung sounds inside our body.

### Page 4: Comb and paper sounds

As you hum, you are blowing air past the comb and paper. This makes the paper and the comb's teeth vibrate. This produces a louder musical note.

### Page 5: Turkey gobbler

As the wet paper towel moves along the string, it grips a little, then slips a little, then grips again, and so on. This makes the string vibrate. The vibrations travel up the string to the cup. The cup starts to vibrate too, making the gobbling sound louder.

### Page 6: Making a stethoscope

The stethoscope you have made helps you to hear faint sounds inside your body. As your heart beats, small vibrations are made. These vibrations travel into the funnel making the air inside the tube vibrate. The vibrating air carries the sound of the heart beat through the tube until it reaches your ear.

### Page 7: Wave generator

Water waves move in a similar way to the wave generator you have built. For example, particles of water move back and forth as the water wave moves along just as the ends of the straws moved back and forth as the wave moved along your wave generator. Waves that move in this way are called transverse waves. Light and radio waves move in the same way through the air or even through a vacuum – they are also transverse waves.

### Page 8: Gravity on a sheet

The marble orbits around the stone, each time passing closer and closer to the stone. This activity models what a planet would do as it approached the Sun. The huge mass

of the Sun would pull the planet — using the force of gravity — so that its orbit passes closer and closer to the Sun. Eventually, the planet would crash into the Sun!

#### Page 9: Balancing bird

In order to balance the bird, its centre of mass needs to be below the balancing point. Before you added plasticine, the bird's centre of mass was above your finger — and the bird toppled over! By adding the plasticine to the tail, you lowered the bird's centre of mass to a new position — below your finger. You can now balance the bird on your finger. Objects with a lower centre of mass are easier to balance than ones with a higher centre of mass. When tightrope walkers walk along the tightrope, they often hold a long pole. This lowers their centre of mass and helps them to balance more easily.

#### Page 10: Making windmills

The windmill surfaces are angled to the direction of air blown towards it. This causes the air to flow to one side of each windmill blade, making the windmill turn around. If you change the angle of the blades, or if you angle some blades one way and other blades another way, this will affect how fast the windmill will turn. The tubing or bead pasta helps the windmill to turn more easily by reducing friction around the pin. Windmills have been used for centuries to grind grain into flour, rock into dust and to pump water from wells. Today, scientists are designing very efficient windmills to produce electricity.

#### Page 11: Blowing out candles

As you blow towards the flat cardboard, most of the air moves away from the candle flame. The cardboard is a good shield and it is difficult to blow out the flame. As you blow towards the round tin, some of the air flows around the curved sides of the tin towards the candle flame. The tin is not a good shield and it is easy to blow out the flame. An understanding of how air flows over curved surfaces has led to many useful things being built. For example, the curved shape of the upper surface of plane wings helps planes to fly.

#### Page 12: Wind roller

The surfaces of the wind roller are angled so that they are at an angle to the air blowing it along. This causes the device to roll as air flows to one side of each blade. If you change the angle of the blades, or if you angle some blades one way and other blades another way, this will affect how fast the roller will turn.

#### Page 13: Spinning spook

As the paper spook falls, air tries to slow it down. The air causes the spook to twist and turn as air moves around its edges. Sometimes this starts the spook spinning, which makes it easier for the air to flow around the edges. Certain shapes of paper will make the spook spin more easily.

#### Page 14: Parachute

As the parachute falls, air is trapped under its canopy and slows it down. Early parachute designs tipped from side to side so that the air could spill over the edges as the parachute falls — this created a very uncomfortable ride for the person. Modern parachutes have vents or small openings in the canopy (like the hole in the centre of your parachute). These vents help the air to flow steadily but not to quickly 'through' the canopy — creating a much smoother ride! The vents can be controlled by the parachutist to steer the parachute in a particular direction.

### Page 15: Ring wing glider

The surfaces of the rings act like the wings of a plane, enabling the glider to fly as it moves through the air. There are many interesting things to investigate in this activity, such as what happens if you launch the glider with the large ring at the front. Why does this happen? Ring wing designs have been drawn up by aeronautical engineers, such as the NASA Lockheed-Georgia design illustrated.

### Page 16: Egg in a bottle

The paper burns until the oxygen in the air is used up. The heated air trapped in the bottle cools after the burning stops. As the air cools, the air pressure inside the bottle becomes less. The higher air pressure outside pushes the egg through the neck and into the bottle!

### Page 17: Pneumatic rockets

As your hands push inwards, the air pressure inside the bottle is increased. The air in the bottle pushes outwards in all directions. Some of the air pushes up on the rocket, launching the rocket up into the air. A quick hard squeeze should make the rocket go higher.

### Page 18: Lifting with air

As you blow through the tube, air is pushed into the bag. The air in the bag pushes outwards in all directions – pressing down onto the table, out towards the sides, and up onto the book, lifting the book higher. Using a pump to push air into a bicycle tyre lifts the wheel higher too! Many types of machines use compressed air to lift things.

### Page 19: Simple fire extinguisher

As vinegar reacts with bicarb soda, bubbles of carbon dioxide gas are formed. Carbon dioxide gas is heavier (more dense) than air and flows down through the opening and over the candle flame. Carbon dioxide puts the flame out. It is oxygen in the air which keeps a flame burning. When carbon dioxide flows over the flame, it stops oxygen from reaching the flame and the flame is extinguished! Some real fire extinguishers produce carbon dioxide gas to put out flames.

### Page 20: Water wheel

The tap water falls onto one side of the balloon, pushing that side down. The other side of the balloon moves up. By keeping the water flowing, the balloon keeps turning just like a wheel! Moving water is often used to turn wheels so that useful work is done. For example, flowing water turns wheels to grind grain to make flour, and spins turbines to make electricity.

### Page 21: Swimming fish

When cooking oil touches the surface of water, it reduces the force holding the water particles together on the surface. The cooking oil flows out the back of the fish reducing the force behind the fish. Therefore the water particles in front of the fish pull the fish more strongly, making the fish 'swim' forward! Other substances such as detergent and soap also reduce the force holding water particles together on the surface – the force is known as surface tension.

### Page 22: Bubbles

The reason why detergent is added to make bubble solution is to reduce the surface tension forces acting between particles on the surface of the water. Water alone will not stretch enough to form bubbles. With detergent however, the water particles can be stretched apart to make bubbles. The glycerine slows down the drying of the bubble

film, so that the bubbles are stronger and last longer. By experimenting with different amounts of detergent and glycerine, you will find that some mixes are stronger than others. Bubble films will always occupy the smallest surface area possible – a sphere being the smallest surface area if enclosing a volume of air. The films produced on various bubble frames will be shaped to form the smallest surface area possible.

#### Page 23: Soils and water absorption

The soil with the biggest damp area around it is the least absorbent soil. The soil with the smallest damp area around it is the most absorbent soil. Some soils are very good at absorbing water – others are not. If we are using soils to grow plants and crops, it is important to know whether the soil is good at absorbing water or not. Some plants grow better in dryer soils, others grow better in wetter soils.

#### Page 24: Floating a straw

This helps you to learn about density. An object of a certain size will be more dense if it has more mass. It will be less dense if it has less mass. The object will float if it is less dense than the liquid it floats in. It will sink if it is more dense than the liquid. The density of a liquid can change if it is heated or cooled down. Hot water is less dense than ice cold water. A straw which just floats in cold water may sink in hot water! A captain of a ship needs to understand this – if the ship just floats in cold water, it may sink if it travels to where the water is warmer!

#### Page 25: Cartesian diver

The 'diver' contains a small bubble of air, just enough to make it float. When the bottle is squeezed the air in the diver is squashed. More water fills the diver and it becomes heavier (more dense) and sinks. When you stop squeezing, the air in the diver pushes some water out and the 'diver' becomes less dense and rises again.

#### Page 26: Dancing spaghetti

Vinegar reacts with bicarb soda to form small bubbles of carbon dioxide gas. These small bubbles attach themselves to the pieces of spaghetti. With the gas bubbles attached, the spaghetti is less dense than the water and it floats to the surface. Once it reaches the surface, the gas bubbles escape into the air. The spaghetti becomes more dense than water again and sinks to the bottom. More gas bubbles stick to the spaghetti and the up and down movement of the spaghetti pieces continue.

#### Page 27: Making indicator paper

Red cabbage water is an indicator of acidic or alkaline solutions. The dye from the cabbage is red, but when other solutions are added to it its colour changes. The cabbage dye on the filter Paper soaked with cabbage dye turns red in an acidic solution (eg lemon juice) and blue in an alkaline solution (eg ammonia cleaning solution). Traditional rug makers use this principle to colour rugs. They use dyes extracted by boiling certain plants and add acidic or alkaline solutions to change their colours.

#### Page 28: Sifting sieves

In Antigua, our grandmothers once used a piece of sea fan coral to sieve flour. Now we do not take coral from the sea since little is left – it is important to conserve our natural world. To sift foods such as flour, we can make sieves with certain sized holes to separate the flour or grains of food from other parts of food. Sieves are useful in other ways too! Micro-sieves can filter dust from air in air-conditioning systems. Sieves can separate different size pebbles and gravels from quarries. They can even be used to sort different sized lollies or candy for packaging!



### Page 29: Mystery tower

Cola contains chemicals which give it a dark brown colour. When you pour it through the sand, the grains act like a sieve or filter and separate the brown chemicals from the liquid. The chemicals stick or adhere to the surface of the grains as the cola flows through the grains.

### Page 30: Whizzer spinners

When the circle spins, our eyes detect the separate colours. Our brain, however, receives these messages so quickly we think the colours are mixed together. This is why the whizzer spinner may appear white (or a colour similar to white). White light is made up of the colours of the spectrum – seven major colours of the spectrum are red, orange, yellow, green, blue, indigo and violet. We can also see the colours of white light when light is scattered by tiny water drops in the sky to form a rainbow!

### Page 31: Now you see, now you can't

The sun's rays passing through a window or a cloud are always straight. Looking through the straight tube you can see the object, but when the tube is bent you cannot see the object. Light only changes direction if it hits a shiny surface such as a mirror. How could you make a bent tube so that light will go all the way through (like it does in a periscope)?

### Page 32: Hole in your hand

Each eye forms a separate image of an object. In the brain both images are combined to form one image. With the tube over one eye and your hand in front of the other your brain overlays the image of the hole onto the image of your hand – making it look like you have a hole in your hand!

### Page 33: Olfactoria

Inside our nose, there are 'receptors' which detect different smells. As we sense different smells, our brain remembers what the smell comes from. The source of some smells are easier to remember than others. The sense of smell is important to us. It can help us to enjoy what we eat, or it can warn us that something is dangerous to eat. Many animals have a much better developed sense of smell than people. This helps them to detect where to get food, or to avoid predators.

### Page 34: What's inside my body?

Your body consists of many parts, including the organs such as your brain, heart, lungs, liver, stomach, intestine, kidney and bladder. Each organ has a special function. For example, your heart pumps blood to all parts of your body, your lungs remove waste gases from your blood and replace them with oxygen which your body cells need to survive and grow, and your stomach and intestine break dissolve food into small particles which can be absorbed into your bloodstream and transported to the cells where the food particles provide energy for life and growth.

### Page 35: I'm stuck

There are many different types of glue and sticky tape adhesives because there are many different types of surfaces. Some adhesives work in holding some surfaces together, others work on different surfaces. Some work for a short time, others are very long lasting. Some join surfaces in a weak way, others in a very strong way. Some glues take a long time to dry, others are instant. When joining some things together, it may be better to use other things such as staples, rubber bands, velcro, screws or nails. Try this special way to stick a balloon to a wall – rub the balloon on your clothing or hair, then hold it against the wall. Let go – does it stick? Try different surfaces.