

# Public Playground Safety Handbook

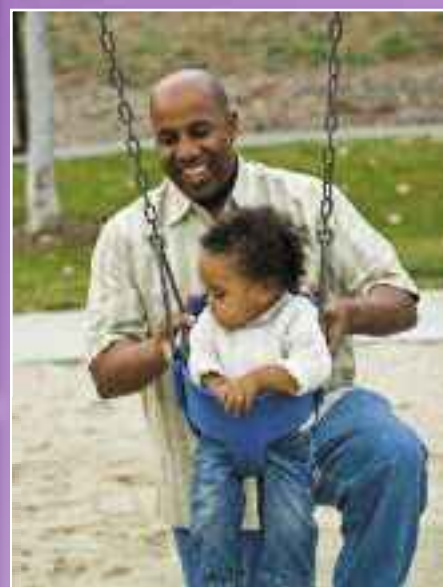

**U.S. Consumer Product Safety Commission**  
*Saving Lives and Keeping Families Safe*





U.S. CONSUMER PRODUCT SAFETY COMMISSION  
4330 EAST WEST HIGHWAY  
BETHESDA, MD 20814

December 29, 2015

The U.S. Consumer Product Safety Commission's ("CPSC" or "Commission") *Public Playground Safety Handbook* was first published in 1981 under the name *A Handbook for Public Playground Safety*. The recommendations in the *Handbook* are focused on playground-related *injuries* and mechanical mechanisms of injury; falls from playground equipment have remained the largest single hazard pattern associated with playground use. Since the first edition, the Commission has included recommendations that playgrounds not be installed over concrete, asphalt, or paved surfaces to address serious head injuries due to falls from the equipment. Additionally, the Commission has made suggestions for commonly used loose-fill and unitary surfacing materials (*e.g.*, wood mulch, pea gravel, sand, gym mats, and shredded/recycled rubber mulch) that provide head impact attenuation and can mitigate the hazard presented by falls from playground equipment. Maintaining the focus on falls, the *Handbook's* surfacing recommendations are based on the surfacing material's energy absorbing effectiveness.

During the past 35 years, innovations in technology have led to new playground equipment and surfacing practices. Voluntary standards for equipment and impact attenuation for protective surfacing have evolved. The 2010 edition of the *Handbook*, the most recent version, still discusses common materials, but also covers new surfacing systems that are specifically designed and tested to comply with ASTM F1292, the voluntary standard for measuring impact attenuation of surfacing. Maintaining that focus, Section 2.4 of the *Handbook* identifies shredded/recycled rubber mulch as an "Appropriate Surfacing" product, given that this product can meet the impact attenuation requirements of ASTM F1292, as long as minimum depths of the material are maintained, as specified in Table 2 of Section 2.5. This notation is solely focused on the impact attenuation to minimize serious head injuries, and not on other aspects that may pose other risks, such as chemical exposure or ingestion.

# TABLE OF CONTENTS

Page No.

1.	<b>Introduction</b> .....	1
1.1	Scope .....	1
1.2	Intended Audience .....	1
1.3	What is a Public Playground? .....	1
1.4	Public Playground Safety Voluntary Standards and CPSC Handbook History .....	1
1.4.1	ASTM playground standards .....	2
1.5	Significant Revisions for 2008 .....	2
1.5.1	Equipment guidelines .....	2
1.5.2	Surfacing guidelines .....	2
1.5.3	General guidelines .....	2
1.5.4	Other revisions .....	2
1.6	Background .....	2
1.7	Playground Injuries .....	3
1.8	Definitions .....	3
2	<b>General Playground Considerations</b> .....	5
2.1	Selecting a Site .....	5
2.1.1	Shading considerations .....	5
2.2	Playground Layout .....	5
2.2.1	Accessibility .....	6
2.2.2	Age separation .....	6
2.2.3	Age group .....	6
2.2.4	Conflicting activities .....	6
2.2.5	Sight lines .....	6
2.2.6	Signage and/or labeling .....	6
2.2.7	Supervision .....	7
2.3	Selecting Equipment .....	8
2.3.1	Equipment not recommended .....	8
2.4	Surfacing .....	8
2.4.1	Equipment not covered by protective surfacing recommendations .....	8
2.4.2	Selecting a surfacing material .....	9
2.5	Equipment Materials .....	10
2.5.1	Durability and finish .....	10
2.5.2	Hardware .....	11
2.5.3	Metals .....	12
2.5.4	Paints and finishes .....	12
2.5.5	Wood .....	12
2.6	Assembly and Installation .....	13
3	<b>Playground Hazards</b> .....	14
3.1	Crush and Shearing Points .....	14
3.2	Entanglement and Impalement .....	14
3.2.1	Strings and ropes .....	14
3.3	Entrapment .....	15
3.3.1	Head entrapment .....	15
3.3.2	Partially bound openings and angles .....	16
3.4	Sharp Points, Corners, and Edges .....	16
3.5	Suspended Hazards .....	16

3.6	Tripping Hazards .....	16
3.7	Used Tires .....	17
<b>4</b>	<b>Maintaining a Playground .....</b>	<b>18</b>
4.1	Maintenance Inspections .....	18
4.2	Repairs .....	18
4.3	Maintaining Loose-Fill Surfacing .....	18
4.4	Recordkeeping .....	19
<b>5</b>	<b>Parts of the Playground .....</b>	<b>20</b>
5.1	Platforms, Guardrails and Protective Barriers .....	20
5.1.1	Platforms .....	20
5.1.2	Stepped platforms .....	20
5.1.3	Guardrails and protective barriers .....	20
5.2	Access Methods to Play Equipment .....	22
5.2.1	Ramps, stairways, rung ladders, and step ladders .....	23
5.2.2	Rungs and other hand gripping components .....	24
5.2.3	Handrails .....	24
5.2.4	Transition from access to platform .....	24
5.3	Major Types of Playground Equipment .....	24
5.3.1	Balance beams .....	24
5.3.2	Climbing and upper body equipment .....	24
5.3.3	Log rolls .....	30
5.3.4	Merry-go-rounds .....	30
5.3.5	Seesaws .....	31
5.3.6	Slides .....	32
5.3.7	Spring rockers .....	36
5.3.8	Swings .....	37
5.3.9	Fall height and use zones for composite structure .....	41
5.3.10	Fall height and use zones not specified elsewhere .....	41

## APPENDICES

<b>A</b>	<b>Appendix A: Suggested General Maintenance Checklist .....</b>	<b>43</b>
<b>B</b>	<b>Appendix B: Playground Testing .....</b>	<b>45</b>
B.1	Templates, Gauges, and Testing Tools .....	45
B.2	Test Methods .....	49
B.2.1	Determining whether a projection is a protrusion .....	49
B.2.2	Projections on suspended members of swing assemblies .....	49
B.2.3	Projections on slides .....	49
B.2.4	Entrapment .....	51
B.2.5	Test fixtures .....	52

---

# 1. INTRODUCTION

In recent years, it is estimated that there were more than 200,000 injuries annually on public playgrounds across the country that required emergency room treatment. By following the recommended guidelines in this handbook, you and your community can create a safer playground environment for all children and contribute to the reduction of playground-related deaths and injuries.

## 1.1 Scope

This handbook presents safety information for public playground equipment in the form of guidelines. Publication of this handbook is expected to promote greater safety awareness among those who purchase, install, and maintain public playground equipment. Because many factors may affect playground safety, the U.S. Consumer Product Safety Commission (CPSC) staff believes that guidelines, rather than a mandatory rule, are appropriate. These guidelines are not being issued as the sole method to minimize injuries associated with playground equipment. However, the Commission believes that the recommendations in this handbook along with the technical information in the ASTM standards for public playgrounds will contribute to greater playground safety.

Some states and local jurisdictions may require compliance with this handbook and/or ASTM voluntary standards. Additionally, risk managers, insurance companies, or others may require compliance at a particular site; check with state/local jurisdictions and insurance companies for specific requirements.

## 1.2 Intended Audience

This handbook is intended for use by childcare personnel, school officials, parks and recreation personnel, equipment purchasers and installers, playground designers, and any other members of the general public (e.g., parents and school groups) concerned with public playground safety and interested in evaluating their respective playgrounds. Due to the wide range of possible users, some information provided may be more appropriate for certain users than others. The voluntary standards listed in 1.4.1 contain more technical requirements than this handbook and are primarily intended for use by equipment manufacturers, architects, designers, and any others requiring more technical information.

## 1.3 What is a Public Playground?

“Public” playground equipment refers to equipment for use by children ages 6 months through 12 years in the playground areas of:

- Commercial (non-residential) child care facilities
- Institutions
- Multiple family dwellings, such as apartment and condominium buildings
- Parks, such as city, state, and community maintained parks
- Restaurants
- Resorts and recreational developments
- Schools
- Other areas of public use

These guidelines are not intended for amusement park equipment, sports or fitness equipment normally intended for users over the age of 12 years, soft contained play equipment, constant air inflatable play devices for home use, art and museum sculptures (not otherwise designed, intended and installed as playground equipment), equipment found in water play facilities, or home playground equipment. Equipment components intended solely for children with disabilities and modified to accommodate such users also are not covered by these guidelines. Child care facilities, especially indoor, should refer to ASTM F2373 — *Standard Consumer Safety Performance Specification for Public Use Play Equipment for Children 6 Months Through 23 Months*, for more guidance on areas unique to their facilities.

## 1.4 Public Playground Safety Voluntary Standards and CPSC Handbook History

- 1981 – First CPSC *Handbook for Public Playground Safety* was published, a two-volume set.
- 1991 – *Standard Specification for Impact Attenuation of Surface Systems Under and Around Playground Equipment*, ASTM F1292, was first published.
- 1991 – Two-volume set was replaced by a single-volume handbook, which contained recommendations based on a COMSIS Corporation report to the CPSC (*Development of Human Factors Criteria for Playground Equipment Safety*).

- 1993 – First version of voluntary standard for public playground equipment, ASTM F1487 — *Standard Consumer Safety Performance Specification for Playground Equipment for Public Use*, was published (revisions occur every 3 to 4 years).
- 1994 – Minor revisions to the *Handbook*.
- 1997 – *Handbook* was updated based on (1) staff review of ASTM F1487, (2) playground safety roundtable meeting held October 1996, and (3) public comment received to a May 1997 CPSC staff request.
- 2005 – First version of voluntary standard for playground equipment intended for children under two years old, ASTM F2373 — *Standard Consumer Safety Performance Specification for Public Use Play Equipment for Children 6 Months Through 23 Months*, was published.
- 2008 – *Handbook* was updated based on comments received from members of the ASTM F15 Playground Committees in response to a CPSC staff request for suggested revisions. Significant revisions are listed below.

#### 1.4.1 ASTM playground standards

Below is a list of ASTM technical performance standards that relate to playgrounds.

- **F1487** *Standard Consumer Safety Performance Specification for Playground Equipment for Public Use*.
- **F2373** *Standard Consumer Safety Performance Specification for Public Use Play Equipment for Children 6 Months through 23 Months*.
- **F1292** *Standard Specification for Impact Attenuation of Surface Systems Under and Around Playground Equipment*.
- **F2075** *Standard Specification for Engineered Wood Fiber for Use as a Playground Safety Surface Under and Around Playground Equipment*.
- **F2223** *Standard Guide for ASTM Standards on Playground Surfacing*.
- **F2479** *Standard Guide for Specification, Purchase, Installation and Maintenance of Poured-In-Place Playground Surfacing*.
- **F1951** *Standard Specification for Determination of Accessibility of Surface Systems Under and Around Playground Equipment*.
- **F1816** *Standard Safety Specification for Drawstrings on Children's Upper Outerwear*.
- **F2049** *Standard Guide for Fences/Barriers for Public, Commercial, and Multi-Family Residential Use Outdoor Play Areas*.
- **F1148** *Standard Consumer Safety Performance Specification for Home Playground Equipment*.
- **F1918** *Standard Safety Performance Specification for Soft Contained Play Equipment*.

## 1.5 Significant Revisions for 2008

### 1.5.1 Equipment guidelines

- Age ranges expanded to include children as young as 6 months based on ASTM F2373
- Guidelines for track rides and log rolls added
- Exit zone requirements for slides harmonized with ASTM F1487

### 1.5.2 Surfacing guidelines

- Critical height table revised
- Suggestions for surfacing over asphalt added

### 1.5.3 General guidelines

- Suggestions on sun exposure added

### 1.5.4 Other revisions

- Editorial changes to make the *Handbook* easier to understand and use

## 1.6 Background

The safety of each individual piece of playground equipment as well as the layout of the entire play area should be considered when designing or evaluating a playground for safety. Since falls are a very common playground hazard pattern, the installation and maintenance of protective surfacing under and around all equipment is crucial to protect children from severe head injuries.

Because all playgrounds present some challenge and because children can be expected to use equipment in unintended and unanticipated ways, adult supervision is highly recommended. The handbook provides some guidance on supervisory practices that adults should follow. Appropriate equipment design, layout, and maintenance, as discussed in this

handbook, are also essential for increasing public playground safety.

A playground should allow children to develop gradually and test their skills by providing a series of graduated challenges. The challenges presented should be appropriate for age-related abilities and should be ones that children can perceive and choose to undertake. Toddlers, preschool- and school-age children differ dramatically, not only in physical size and ability, but also in their intellectual and social skills. Therefore, age-appropriate playground designs should accommodate these differences with regard to the type, scale, and the layout of equipment. Recommendations throughout this handbook address the different needs of toddlers, preschool-age, and school-age children; “toddlers” refers to children ages 6 months through 2 years of age, “preschool-age” refers to children 2 through 5 years, and “school-age” refers to children 5 through 12 years. The overlap between these groups is anticipated in terms of playground equipment use and provides for a margin of safety.

Playground designers, installers and operators should be aware that the Americans with Disabilities Act of 1990 (ADA) is a comprehensive civil rights law which prohibits discrimination on the basis of disability. Titles II and III of the ADA require, among other things, that newly constructed and altered State and local government facilities, places of public accommodation, and commercial facilities be readily accessible to and usable by individuals with disabilities. Recreation facilities, including play areas, are among the types of facilities covered by titles II and III of the ADA.

The Architectural and Transportation Barriers Compliance Boards – also referred to as the “Access Board” – has developed accessibility guidelines for newly constructed and altered play areas that were published October 2000. The play area guidelines are a supplement to the Americans with Disabilities Act Accessibility Guidelines (ADAAG). Once these guidelines are adopted as enforceable standards by the Department of Justice, all newly constructed and altered play areas covered by the ADA will be required to comply. These guidelines also apply to play areas covered by the Architectural Barriers Act (ABA).

Copies of the play area accessibility guidelines and further technical assistance can be obtained from the U.S. Access Board, 1331 F Street, NW, Suite 1000, Washington, DC 20004-1111; 800-872-2253, 800-993-2822 (TTY), [www.access-board.gov](http://www.access-board.gov).

## 1.7 Playground Injuries

The U. S. Consumer Product Safety Commission has long recognized the potential hazards that exist with the use of playground equipment, with over 200,000 estimated emergency room-treated injuries annually. The most recent study of 2,691 playground equipment-related incidents reported to the CPSC from 2001-2008 indicated that falls are the most common hazard pattern (44% of injuries) followed by equipment-related hazards, such as breakage, tip over, design, and assembly (23%).<sup>1</sup> Other hazard patterns involved entrapment and colliding other children or stationary equipment. Playground-related deaths reported to the Commission involved entanglement of ropes, leashes, or clothing; falls; and impact from equipment tip over or structural failure.

The recommendations in this handbook have been developed to address the hazards that resulted in playground-related injuries and deaths. The recommendations include those that address:

- The potential for falls from and impact with equipment
- The need for impact attenuating protective surfacing under and around equipment
- Openings with the potential for head entrapment
- The scale of equipment and other design features related to user age and layout of equipment on a playground
- Installation and maintenance procedures
- General hazards presented by protrusions, sharp edges, and crush or shear points

## 1.8 Definitions

**Barrier** — An enclosing device around an elevated platform that is intended to prevent both inadvertent and deliberate attempts to pass through the device.

**Composite Structure** — Two or more play structures attached or functionally linked, to create one integral unit that provides more than one play activity.

**Critical Height** — The fall height below which a life-threatening head injury would not be expected to occur.

<sup>1</sup>O'Brien, Craig W.; Injuries and Investigated Deaths Associated with Playground Equipment, 2001–2008. U.S. Consumer Product Safety Commission: Washington DC, October, 2009.

**Designated Play Surface** — Any elevated surface for standing, walking, crawling, sitting or climbing, or a flat surface greater than 2 inches wide by 2 inches long having an angle less than 30° from horizontal.

**Embankment Slide** — A slide that follows the contour of the ground and at no point is the bottom of the chute greater than 12 inches above the surrounding ground.

**Entanglement** — A condition in which the user's clothes or something around the user's neck becomes caught or entwined on a component of playground equipment.

**Entrapment** — Any condition that impedes withdrawal of a body or body part that has penetrated an opening.

**Fall Height** — The vertical distance between the highest designated play surface on a piece of equipment and the protective surfacing beneath it.

**Footing** — A means for anchoring playground equipment to the ground.

**Full Bucket Seat Swing** — A swing generally appropriate for children under 4 years of age that provides support on all sides and between the legs of the occupant and cannot be entered or exited without adult assistance.

**Geotextile (filter) Cloth** — A fabric that retains its relative structure during handling, placement, and long-term service to enhance water movement, retard soil movement, and to add reinforcement and separation between the soil and the surfacing and/or sub-base.

**Guardrail** — An enclosing device around an elevated platform that is intended to prevent inadvertent falls from the elevated surface.

**Infill** — Material(s) used in a protective barrier or between decks to prevent a user from passing through the barrier (e.g., vertical bars, lattice, solid panel, etc.).

**Loose-Fill Surfacing Material** — A material used for protective surfacing in the use zone that consists of loose particles such as sand, gravel, engineered wood fibers, or shredded rubber.

**Preschool-Age Children** — Children 2 years of age through 5 years of age.

**Projection** — Anything that extends outward from a surface of the playground equipment and must be tested to determine whether it is a protrusion or entanglement hazard, or both.

**Protective Barrier** — See Barrier.

**Protective Surfacing** — Shock absorbing (i.e., impact attenuating) surfacing material in the use zone that conforms to the recommendations in §2.4 of this handbook.

**Protrusion** — A projection which, when tested, is found to be a hazard having the potential to cause bodily injury to a user who impacts it.

**Roller Slide** — A slide that has a chute consisting of a series of individual rollers over which the user travels.

**School-Age Children** — Children 5 years of age through 12 years of age.

**Slide Chute** — The inclined sliding surface of a slide.

**Stationary Play Equipment** — Any play structure that has a fixed base and does not move.

**Supervisor** — Any person tasked with watching children on a playground. Supervisors may be paid professionals (e.g., childcare, elementary school or park and recreation personnel), paid seasonal workers (e.g., college or high school students), volunteers (e.g., PTA members), or unpaid caregivers (e.g., parents) of the children playing in the playground.

**Toddlers** — Children 6 months through 23 months of age.

**Tube Slide** — A slide in which the chute consists of a totally enclosed tube or tunnel.

**Unitary Surfacing Material** — A manufactured material used for protective surfacing in the use zone that may be rubber tiles, mats, or a combination of energy absorbing materials held in place by a binder that may be poured in place at the playground site and cures to form a unitary shock absorbing surface.

**Upper Body Equipment** — Equipment designed to support a child by the hands only (e.g., horizontal ladder, overhead swinging rings).

**Use Zone** — The surface under and around a piece of equipment onto which a child falling from or exiting from the equipment would be expected to land. These areas are also designated for unrestricted circulation around the equipment.



## 2. GENERAL PLAYGROUND CONSIDERATIONS

### 2.1 Selecting a Site

The following factors are important when selecting a site for a new playground:

Site Factor	Questions to Ask	If yes, then...Mitigation
Travel patterns of children to and from the playground	Are there hazards in the way?	Clear hazards.
Nearby accessible hazards such as roads with traffic, lakes, ponds, streams, drop-offs/cliffs, etc.	<p>Could a child inadvertently run into a nearby hazard?</p> <p>Could younger children easily wander off toward the hazard?</p>	Provide a method to contain children within the playground. For example, a dense hedge or a fence. The method should allow for observation by supervisors. If fences are used, they should conform to local building codes and/or ASTM F-2049.
Sun exposure	Is sun exposure sufficient to heat exposed bare metal slides, platforms, steps, & surfacing enough to burn children?	<p>Bare metal slides, platforms, and steps should be shaded or located out of direct sun.</p> <p>Provide warnings that equipment and surfacing exposed to intense sun can burn.</p>
	Will children be exposed to the sun during the most intense part of the day?	Consider shading the playground or providing shaded areas nearby.
Slope and drainage	Will loose fill materials wash away during periods of heavy rain?	Consider proper drainage re-grading to prevent wash outs.

#### 2.1.1 Shading considerations

According to the American Academy of Dermatology, research indicates that one in five Americans will develop some form of skin cancer during their lifetime, and five or more sunburns double the risk of developing skin cancer. Utilizing existing shade (e.g., trees), designing play structures as a means for providing shading (e.g., elevated platforms with shaded space below), or creating more shade (e.g., man-made structures) are potential ways to design a playground to help protect children's skin from the sun. When trees are used for shade, additional maintenance issues arise, such as the need for cleaning up debris and trimming limbs.

#### 2.2 Playground Layout

There are several key factors to keep in mind when laying out a playground:

- Accessibility
- Age separation
- Conflicting activities
- Sight lines
- Signage and/or labeling
- Supervision

### 2.2.1 Accessibility

Special consideration should be given to providing accessible surfaces in a play area that meets the ASTM *Standard Specification for Determination of Accessibility of Surface Systems Under and Around Playground Equipment*, ASTM F1951.

Equipment selection and location along with the type of protective surfacing are key components to ensuring the opportunity for children with disabilities to play on the playground.

### 2.2.2 Age separation

For playgrounds intended to serve children of all ages, the layout of pathways and the landscaping of the playground should show the distinct areas for the different age groups. The areas should be separated at least by a buffer zone, which could be an area with shrubs or benches. This separation and buffer zone will reduce the chance of injury from older, more active children running through areas filled with younger children with generally slower movement and reaction times.

### 2.2.3 Age group

In areas where access to the playground is unlimited or enforced only by signage, the playground designer should recognize that since child development is fluid, parents and caregivers may select a playground slightly above or slightly below their child's abilities, especially for children at or near a cut-off age (e.g., 2-years old and 5-years old). This could be for ease of supervising multiple children, misperceptions about the hazards a playground may pose to children of a different age, advanced development of a child, or other reasons. For this reason, there is an overlap at age 5.

Developmentally a similar overlap also exists around age 2; however, due to the differences in ASTM standards and entrapment testing tools, this overlap is not reflected in the handbook. Playgrounds used primarily by children under the supervision of paid, trained professionals (e.g., child-care centers and schools) may wish to consider separating playgrounds by the facility's age groupings. For example, a child-care facility may wish to limit a playground to toddlers under 2 exclusively and can draw information from this guide and ASTM F2373. A school, on the other hand, may have no children under 4 attending, and can likewise plan appropriately. Those who inspect playgrounds should use the intended age group of the playground.

### 2.2.4 Conflicting activities

The play area should be organized into different sections to prevent injuries caused by conflicting activities and children running between activities. Active, physical activities should be separate from more passive or quiet activities. Areas for playground equipment, open fields, and sand boxes should be located in different sections of the playground. In addition, popular, heavy-use pieces of equipment or activities should be dispersed to avoid crowding in any one area.

Different types of equipment have different use zones that must be maintained. The following are general recommendations for locating equipment within the playground site. Specific use zones for equipment are given in §5.3.

- Moving equipment, such as swings and merry-go-rounds, should be located toward a corner, side, or edge of the play area while ensuring that the appropriate use zones around the equipment are maintained.
- Slide exits should be located in an uncongested area of the playground.
- Composite play structures have become increasingly popular on public playgrounds. Adjacent components on composite structures should be complementary. For example, an access component should not be located in a slide exit zone.

### 2.2.5 Sight lines

Playgrounds that are designed, installed, and maintained in accordance with safety guidelines and standards can still present hazards to children. Playgrounds should be laid out to allow parents or caregivers to keep track of children as they move throughout the playground environment. Visual barriers should be minimized as much as possible. For example, in a park situation, playground equipment should be as visible as possible from park benches. In playgrounds with areas for different ages, the older children's area should be visible from the younger children's area to ensure that caregivers of multiple children can see older children while they are engaged in interactive play with younger ones.

### 2.2.6 Signage and/or labeling

Although the intended user group should be obvious from the design and scale of equipment, signs and/or labels posted in the playground area or on the equipment should give some guidance to supervisors as to the age appropriateness of the equipment.

### 2.2.7 Supervision

The quality of the supervision depends on the quality of the supervisor’s knowledge of safe play behavior. Playground designers should be aware of the type of supervision most likely for their given playground. Depending on the location and nature of the playground, the supervisors may be paid professionals (e.g., childcare, elementary school or park and recreation personnel), paid seasonal workers (e.g., college or high school students), volunteers (e.g., PTA members), or unpaid caregivers (e.g., parents) of the children playing in the playground.





Parents and playground supervisors should be aware that not all playground equipment is appropriate for all children who may use the playground. Supervisors should look for posted

signs indicating the appropriate age of the users and direct children to equipment appropriate for their age. Supervisors may also use the information in Table 1 to determine the suitability of the equipment for the children they are supervising. Toddlers and preschool-age children require more attentive supervision than older children; however, one should not rely on supervision alone to prevent injuries.

Supervisors should understand the basics of playground safety such as:

- Checking for broken equipment and making sure children don’t play on it.
- Checking for and removing unsafe modifications, especially ropes tied to equipment, before letting children play.
- Checking for properly maintained protective surfacing.
- Making sure children are wearing foot wear.

**TABLE 1. EXAMPLES OF AGE APPROPRIATE EQUIPMENT**

 <p><b>Toddler – Ages 6-23 months</b></p> <ul style="list-style-type: none"> <li>• Climbing equipment under 32” high</li> <li>• Ramps</li> <li>• Single file step ladders</li> <li>• Slides*</li> <li>• Spiral slides less than 360°</li> <li>• Spring rockers</li> <li>• Stairways</li> <li>• Swings with full bucket seats</li> </ul>	 <p><b>Preschool – Ages 2-5 years</b></p> <ul style="list-style-type: none"> <li>• Certain climbers**</li> <li>• Horizontal ladders less than or equal to 60” high for ages 4 and 5</li> <li>• Merry-go-rounds</li> <li>• Ramps</li> <li>• Rung ladders</li> <li>• Single file step ladders</li> <li>• Slides*</li> <li>• Spiral slides up to 360°</li> <li>• Spring rockers</li> <li>• Stairways</li> <li>• Swings – belt, full bucket seats (2-4 years) &amp; rotating tire</li> </ul>	 <p><b>Grade School – Ages 5-12 years</b></p> <ul style="list-style-type: none"> <li>• Arch climbers</li> <li>• Chain or cable walks</li> <li>• Free standing climbing events with flexible parts</li> <li>• Fulcrum seesaws</li> <li>• Ladders – Horizontal, Rung, &amp; Step</li> <li>• Overhead rings***</li> <li>• Merry-go-rounds</li> <li>• Ramps</li> <li>• Ring treks</li> <li>• Slides*</li> <li>• Spiral slides more than one 360° turn</li> <li>• Stairways</li> <li>• Swings – belt &amp; rotating tire</li> <li>• Track rides</li> <li>• Vertical sliding poles</li> </ul>
<p>* See §5.3.6</p>	<p>** See §5.3.2</p>	<p>*** See §5.3.2.5</p>

- Watching and stopping dangerous horseplay, such as children throwing protective surfacing materials, jumping from heights, etc.
- Watching for and stopping children from wandering away from the play area.

## 2.3 Selecting Equipment

When selecting playground equipment, it is important to know the age range of the children who will be using the playground. Children at different ages and stages of development have different needs and abilities. Playgrounds should be designed to stimulate children and encourage them to develop new skills, but should be in scale with their sizes, abilities, and developmental levels. Consideration should also be given to providing play equipment that is accessible to children with disabilities and encourages integration within the playground.

Table 1 shows the appropriate age range for various pieces of playground equipment. This is not an all-comprehensive list and, therefore, should not limit inclusion of current or newly designed equipment that is not specifically mentioned. For equipment listed in more than one group, there may be some modifications or restrictions based on age, so consult the specific recommendations in §5.3.

### 2.3.1 Equipment not recommended

Some playground equipment is not recommended for use on public playgrounds, including:

- Trampolines
- Swinging gates
- Giant strides
- Climbing ropes that are not secured at both ends.
- Heavy metal swings (e.g., animal figures) – These are not recommended because their heavy rigid metal framework presents a risk of impact injury.
- Multiple occupancy swings – With the exception of tire swings, swings that are intended for more than one user are not recommended because their greater mass, as compared to single occupancy swings, presents a risk of impact injury.
- Rope swings – Free-swinging ropes that may fray or otherwise form a loop are not recommended because they present a potential strangulation hazard.
- Swinging dual exercise rings and trapeze bars – These are rings and trapeze bars on long chains that are generally considered to be items of athletic equipment and are not recommended for public playgrounds. *NOTE: The recommendation against the use of exercise rings does not apply to overhead hanging rings such as those used in a ring trek or ring ladder (see Figure 7).*



## 2.4 Surfacing

The surfacing under and around playground equipment is one of the most important factors in reducing the likelihood of life-threatening head injuries. A fall onto a shock absorbing surface is less likely to cause a

serious head injury than a fall onto a hard surface. However, some injuries from falls, including broken limbs, may occur no matter what playground surfacing material is used.

The most widely used test method for evaluating the shock absorbing properties of a playground surfacing material is to drop an instrumented metal headform onto a sample of the material and record the acceleration/time pulse during the impact. Field and laboratory test methods are described in ASTM F1292 *Standard Specification for Impact Attenuation of Surface Systems Under and Around Playground Equipment*.

Testing using the methods described in ASTM F1292 will provide a “critical height” rating of the surface. This height can be considered as an approximation of the fall height below which a life-threatening head injury would not be expected to occur. Manufacturers and installers of playground protective surfacing should provide the critical height rating of their materials. This rating should be greater than or equal to the fall height of the highest piece of equipment on the playground. The fall height of a piece of equipment is the distance between the highest designated play surface on a piece of equipment and the protective surface beneath it. Details for determining the highest designated play surface and fall height on some types of equipment are included in §5 Parts of the Playground.

### 2.4.1 Equipment not covered by protective surfacing recommendations

The recommendations for protective surfacing do not apply to equipment that requires a child to be standing or sitting at *ground level*. Examples of such equipment are:



### Appropriate Surfacing

- Any material tested to ASTM F1292, including unitary surfaces, engineered wood fiber, etc.
- Pea gravel
- Sand
- Shredded/recycled rubber mulch
- Wood mulch (not CCA-treated)
- Wood chips

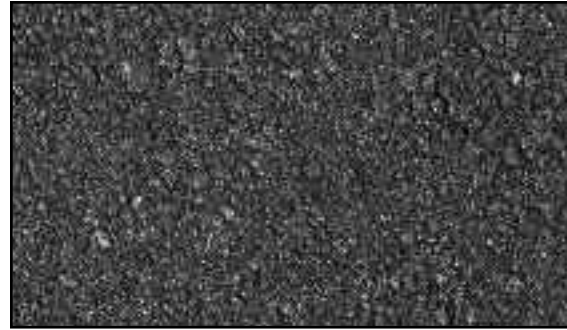

### Inappropriate Surfacing

- Asphalt
- Carpet not tested to ASTM F1292
- Concrete
- Dirt
- Grass
- CCA treated wood mulch

- Sand boxes
- Activity walls at ground level
- Play houses
- Any other equipment that children use when their feet remain in contact with the ground surface

## 2.4.2 Selecting a surfacing material

There are two options available for surfacing public playgrounds: unitary and loose-fill materials. A playground should never be installed without protective surfacing of some type. Concrete, asphalt, or other hard surfaces should never be directly under playground equipment. Grass and dirt are not considered protective surfacing because wear and environmental factors can reduce their shock absorbing effectiveness. Carpeting and mats are also not appropriate unless they are tested to and comply with ASTM F1292. Loose-fill should be avoided for playgrounds intended for toddlers.

### 2.4.2.1 Unitary surfacing materials

Unitary materials are generally rubber mats and tiles or a combination of energy-absorbing materials held in place by a

binder that may be poured in place at the playground site and then cured to form a unitary shock absorbing surface. Unitary materials are available from a number of different manufacturers, many of whom have a range of materials with differing shock absorbing properties. New surfacing materials, such as bonded wood fiber and combinations of loose-fill and unitary, are being developed that may also be tested to ASTM F1292 and fall into the unitary materials category. When deciding on the best surfacing materials keep in mind that some dark colored surfacing materials exposed to the intense sun have caused blistering on bare feet. Check with the manufacturer if light colored materials are available or provide shading to reduce direct sun exposure.

Persons wishing to install a unitary material as a playground surface should request ASTM F1292 test data from the manufacturer identifying the critical height rating of the desired surface. In addition, site requirements should be obtained from the manufacturer because some unitary materials require installation over a hard surface while others do not. Manufacturer's instructions should be followed closely, as some unitary systems require professional installation. Testing should be conducted in accordance with the ASTM F1292 standard.

### 2.4.2.2 Loose-fill surfacing materials

Engineered wood fiber (EWF) is a wood product that may look similar in appearance to landscaping mulch, but EWF products are designed specifically for use as a playground safety surface under and around playground equipment. EWF products should meet the specifications in ASTM F2075: *Standard Specification for Engineered Wood Fiber* and be tested to and comply with ASTM F1292.

There are also rubber mulch products that are designed specifically for use as playground surfacing. Make sure they have been tested to and comply with ASTM F1292.

When installing these products, tips 1-9 listed below should be followed. Each manufacturer of engineered wood fiber and rubber mulch should provide maintenance requirements for and test data on:

- Critical height based on ASTM F1292 impact attenuation testing.
- Minimum fill-depth data.
- Toxicity.
- ADA/ABA accessibility guidelines for firmness and stability based on ASTM F1951.

Other loose-fill materials are generally landscaping-type materials that can be layered to a certain depth and resist compacting. Some examples include wood mulch, wood chips, sand, pea gravel, and shredded/recycled rubber mulch.

Important tips when considering loose-fill materials:

1. Loose-fill materials will compress at least 25% over time due to use and weathering. This must be considered when planning the playground. For example, if the playground will require 9 inches of wood chips, then the initial fill level should be 12 inches. See Table 2 below.
2. Loose-fill surfacing requires frequent maintenance to ensure surfacing levels never drop below the minimum depth. Areas under swings and at slide exits are more susceptible to displacement; special attention must be paid to maintenance in these areas. Additionally, wear mats can be installed in these areas to reduce displacement.
3. The perimeter of the playground should provide a method of containing the loose-fill materials.
4. Consider marking equipment supports with a minimum fill level to aid in maintaining the original depth of material.

5. Good drainage is essential to maintaining loose-fill surfacing. Standing water with surfacing material reduces effectiveness and leads to material compaction and decomposition.
6. Critical height may be reduced during winter in areas where the ground freezes.
7. Never use less than 9 inches of loose-fill material except for shredded/recycled rubber (6 inches recommended). Shallower depths are too easily displaced and compacted.
8. Some loose-fill materials may not meet ADA/ABA accessibility guidelines. For more information, contact the Access Board (see §1.6) or refer to ASTM F1951.
9. Wood mulch containing chromated copper arsenate (CCA)-treated wood products should not be used; mulch where the CCA-content is unknown should be avoided (see §2.5.5.1).

Table 2 shows the minimum required depths of loose-fill material needed based on material type and fall height. The depths shown assume the materials have been compressed due to use and weathering and are properly maintained to the given level.

### 2.4.2.3 Installing loose-fill over hard surface

CPSC staff strongly recommends against installing playgrounds over hard surfaces, such as asphalt, concrete, or hard packed earth, unless the installation adds the following layers of protection. Immediately over the hard surface there should be a 3- to 6-inch base layer of loose-fill (e.g., gravel for drainage). The next layer should be a Geotextile cloth. On top of that should be a loose-fill layer meeting the specifications addressed in §2.4.2.2 and Table 2. Embedded in the loose-fill layer should be impact attenuating mats under high traffic areas, such as under swings, at slide exits, and other places where displacement is likely. Figure 1 provides a visual representation of this information. Older playgrounds that still exist on hard surfacing should be modified to provide appropriate surfacing.

## 2.5 Equipment Materials

### 2.5.1 Durability and finish

- Use equipment that is manufactured and constructed only of materials that have a demonstrated record of durability in a playground or similar setting.

**Table 2. Minimum compressed loose-fill surfacing depths**

Inches	Of	(Loose-Fill Material)	Protects to	Fall Height (feet)
6*		Shredded/recycled rubber		10
9		Sand		4
9		Pea Gravel		5
9		Wood mulch (non-CCA)		7
9		Wood chips		10

\* Shredded/recycled rubber loose-fill surfacing does not compress in the same manner as other loose-fill materials. However, care should be taken to maintain a constant depth as displacement may still occur.

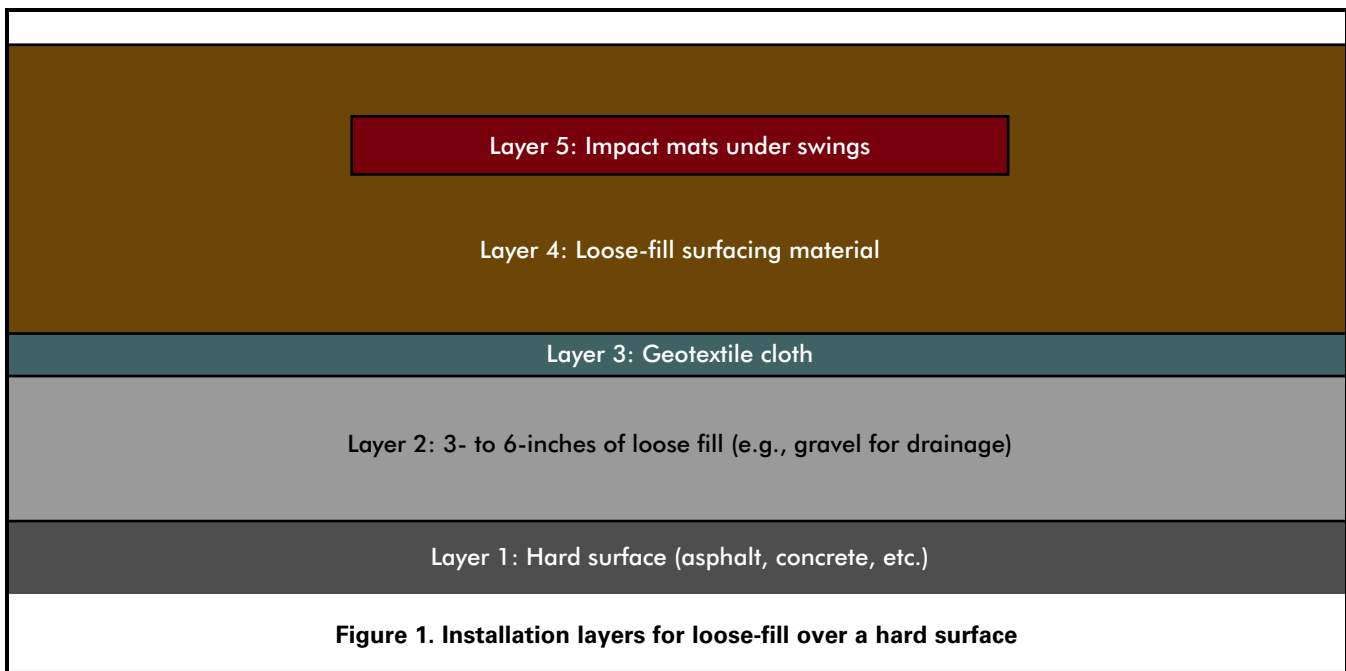

**Figure 1. Installation layers for loose-fill over a hard surface**

- Finishes, treatments, and preservatives should be selected carefully so that they do not present a health hazard to users.

**2.5.2 Hardware**

When installed and maintained in accordance with the manufacturer’s instructions:

- All fasteners, connectors, and covering devices should not loosen or be removable without the use of tools.
- All fasteners, connectors, and covering devices that are exposed to the user should be smooth and should not be likely to cause laceration, penetration, or present a clothing entanglement hazard (see also §3.2 and Appendix B).
- Lock washers, self-locking nuts, or other locking means should be provided for all nuts and bolts to protect them from detachment.
- Hardware in moving joints should also be secured against unintentional or unauthorized loosening.

- All fasteners should be corrosion resistant and be selected to minimize corrosion of the materials they connect. This is particularly important when using wood treated with ACQ/CBA/CA-B<sup>2</sup> as the chemicals in the wood preservative corrode certain metals faster than others.
- Bearings or bushings used in moving joints should be easy to lubricate or be self-lubricating.
- All hooks, such as S-hooks and C-hooks, should be closed (see also §5.3.8.1). A hook is considered closed if there is no gap or space greater than 0.04 inches, about the thickness of a dime.

### 2.5.3 Metals

- Avoid using bare metal for platforms, slides, or steps. When exposed to direct sunlight they may reach temperatures high enough to cause serious contact burn injuries in a matter of seconds. Use other materials that may reduce the surface temperature, such as but not limited to wood, plastic, or coated metal (see also Slides in §5.3.6).
- If bare or painted metal surfaces are used on platforms, steps, and slide beds, they should be oriented so that the surface is not exposed to direct sun year round.

### 2.5.4 Paints and finishes

- Metals not inherently corrosion resistant should be painted, galvanized, or otherwise treated to prevent rust.
- The manufacturer should ensure that the users cannot ingest, inhale, or absorb potentially hazardous amounts of preservative chemicals or other treatments applied to the equipment as a result of contact with playground equipment.
- All paints and other similar finishes must meet the current CPSC regulation for lead in paint.
- Painted surfaces should be maintained to prevent corrosion and deterioration.
- Paint and other finishes should be maintained to prevent rusting of exposed metals and to minimize children playing with peeling paint and paint flakes.

- Older playgrounds with lead based paints should be identified and a strategy to control lead paint exposure should be developed. Playground managers should consult the October 1996 report, CPSC Staff Recommendations for Identifying and Controlling Lead Paint on Public Playground Equipment, while ensuring that all paints and other similar finishes meet the current CPSC regulation.<sup>3</sup>

### 2.5.5 Wood

- Wood should be either naturally rot- and insect-resistant (e.g., cedar or redwood) or should be treated to avoid such deterioration.
- Creosote-treated wood (e.g., railroad ties, telephone poles, etc) and coatings that contain pesticides should not be used.

#### 2.5.5.1 Pressure-treated wood

A significant amount of older playground wood was pressure-treated with chemicals to prevent damage from insects and fungi. Chromated copper arsenate (CCA) was a chemical used for decades in structures (including playgrounds). Since December 31, 2003, CCA-treated wood is no longer processed for use in playground applications. Other rot- and insect-resistant pressure treatments are available that do not contain arsenic; however, when using any of the new treated wood products, be sure to use hardware that is compatible with the wood treatment chemicals. These chemicals are known to corrode certain materials faster than others.

#### *Existing playgrounds with CCA-treated wood*

Various groups have made suggestions concerning the application of surface coatings to CCA-treated wood (e.g., stains and sealants) to reduce a child's potential exposure to arsenic from the wood surface. Data from CPSC staff and EPA studies suggest that regular (at least once a year) use of an oil- or water-based, penetrating sealant or stain can reduce arsenic migration from CCA-treated wood. Installers, builders, and consumers who perform woodworking operations, such as sanding, sawing, or sawdust disposal, on pressure-treated wood should read the consumer information sheet available at the point of sale. This sheet contains important health precautions and disposal information.

---

<sup>2</sup> Ammoniacal copper quat (ACQ), copper boron azole (CBA), copper azole type B (CA-B), etc.

<sup>3</sup> CPSC Staff Recommendations for Identifying and Controlling Lead Paint on Public Playground Equipment; U.S. Consumer Product Safety Commission: Washington, DC, October 1996.



When selecting wood products and finishes for public playgrounds, CPSC staff recommends:

- Avoid “film-forming” or non-penetrating stains (latex semi-transparent, latex opaque and oil-based opaque stains) on outdoor surfaces because peeling and flaking may occur later, which will ultimately have an impact on durability as well as exposure to the preservatives in the wood.
- Creosote, pentachlorophenol, and tributyl tin oxide are too toxic or irritating and should not be used as preservatives for playground equipment wood.
- Pesticide-containing finishes should not be used.
- CCA-treated wood should not be used as playground mulch.

## 2.6 Assembly and Installation

- Strictly follow *all* instructions from the manufacturer when assembling and installing equipment.
- After assembly and before its first use, equipment should be thoroughly inspected by a person qualified to inspect playgrounds for safety.
- The manufacturer’s assembly and installation instructions, and all other materials collected concerning the equipment, should be kept in a permanent file.
- Secure anchoring is a key factor to stable installation, and the anchoring process should be completed in *strict* accordance with the manufacturer’s specifications.

### 3. PLAYGROUND HAZARDS

This section provides a broad overview of general hazards that should be avoided on playgrounds. It is intended to raise awareness of the risks posed by each of these hazards. Many of these hazards have technical specifications and tests for compliance with ASTM F1487 and F2373. Some of these tests are also detailed in Appendix B.

#### 3.1 Crush and Shearing Points

Anything that could crush or shear limbs should not be accessible to children on a playground. Crush and shear points can be caused by parts moving relative to each other or to a fixed part during a normal use cycle, such as a seesaw.

To determine if there is a possible crush or shear point, consider:

- The likelihood a child could get a body part inside the point, and
- The closing force around the point.

Potential crush/shear hazards specific to certain pieces of equipment are identified in §5.3 Major Types of Playground Equipment.

#### 3.2 Entanglement and Impalement

Projections on playground equipment should not be able to entangle children's clothing nor should they be large enough to impale. To avoid this risk:

- The diameter of a projection should not increase in the direction away from the surrounding surface toward the exposed end (see Figure 2).
- Bolts should not expose more than two threads beyond the end of the nut (see Figure 3).
- All hooks, such as S-hooks and C-hooks, should be closed (see also §5.3.8.1). A hook is considered closed if there is no gap or space greater than 0.04 inches, about the thickness of a dime.
  - Any connecting device containing an in-fill that completely fills the interior space preventing entry of clothing items into the interior of the device is exempt from this requirement.

- Swings and slides have additional recommendations for projections detailed in §5.3.
- See Appendix B for testing recommendations.

##### 3.2.1 Strings and ropes

Drawstrings on the hoods of jackets, sweatshirts, and other upper body clothing can become entangled in playground equipment, and can cause death by strangulation. To avoid this risk:

- Children should not wear jewelry, jackets or sweatshirts with drawstring hoods, mittens connected by strings through the arms, or other upper body clothing with drawstrings.
- Remove any ropes, dog leashes, or similar objects that have been attached to playground equipment. Children can become entangled in them and strangle to death.

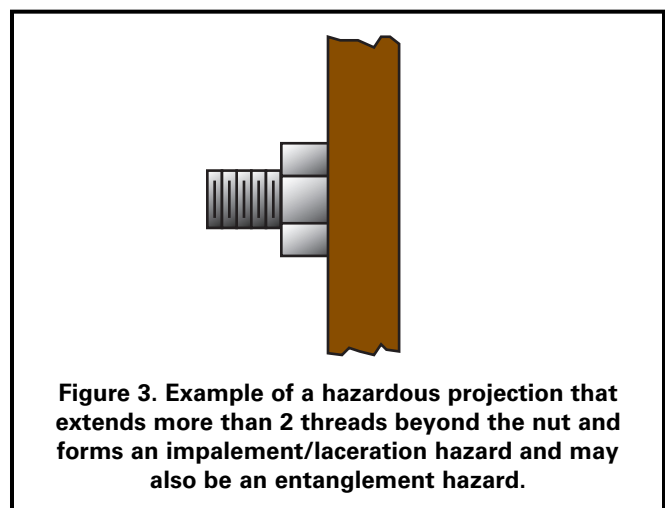
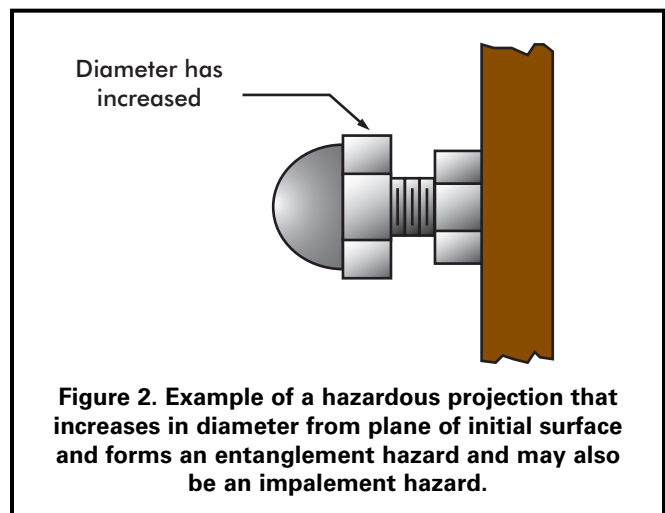

- Avoid equipment with ropes that are not secured at both ends.
- The following label, or a similar sign or label, can be placed on or near slides or other equipment where potential entanglements may occur.

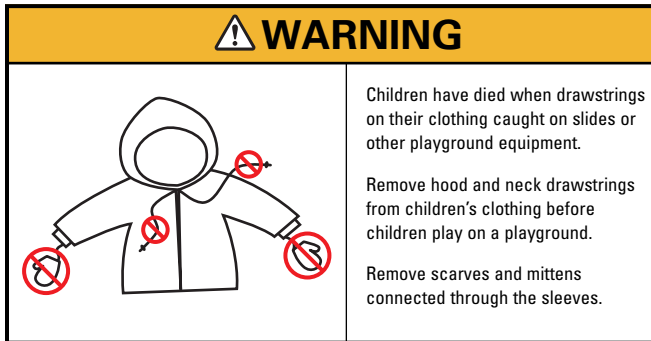

### 3.3 Entrapment

#### 3.3.1 Head entrapment

Head entrapment is a serious concern on playgrounds, since it could lead to strangulation and death. A child's head may become entrapped if the child enters an opening either feet first or head first. Head entrapment by head-first entry generally occurs when children place their heads through an

opening in one orientation, turn their heads to a different orientation, then are unable to get themselves out. Head entrapment by feet first entry involves children who generally sit or lie down and slide their feet into an opening that is large enough to permit their bodies to go through but is not large enough to permit their heads to go through. A part or a group of parts should not form openings that could trap a child's head. Also, children should not wear their bicycle helmets while on playground equipment. There have been recent head entrapment incidents in which children wearing their bicycle helmets became entrapped in spaces that would not normally be considered a head entrapment.

Certain openings could present an entrapment hazard if the distance between any interior opposing surfaces is greater than 3.5 inches and less than 9 inches. These spaces should be tested as recommended in Appendix B. When one dimension of an opening is within this range, all dimensions of the opening should be considered together to evaluate the possibility of entrapment. Even openings that are low enough for children's feet to touch the ground can present a risk of strangulation for an entrapped child. (See Figure 4). Younger children may not have the necessary intellectual ability or motor skills to reverse the process that caused their heads to become trapped, especially if they become scared or panicked.

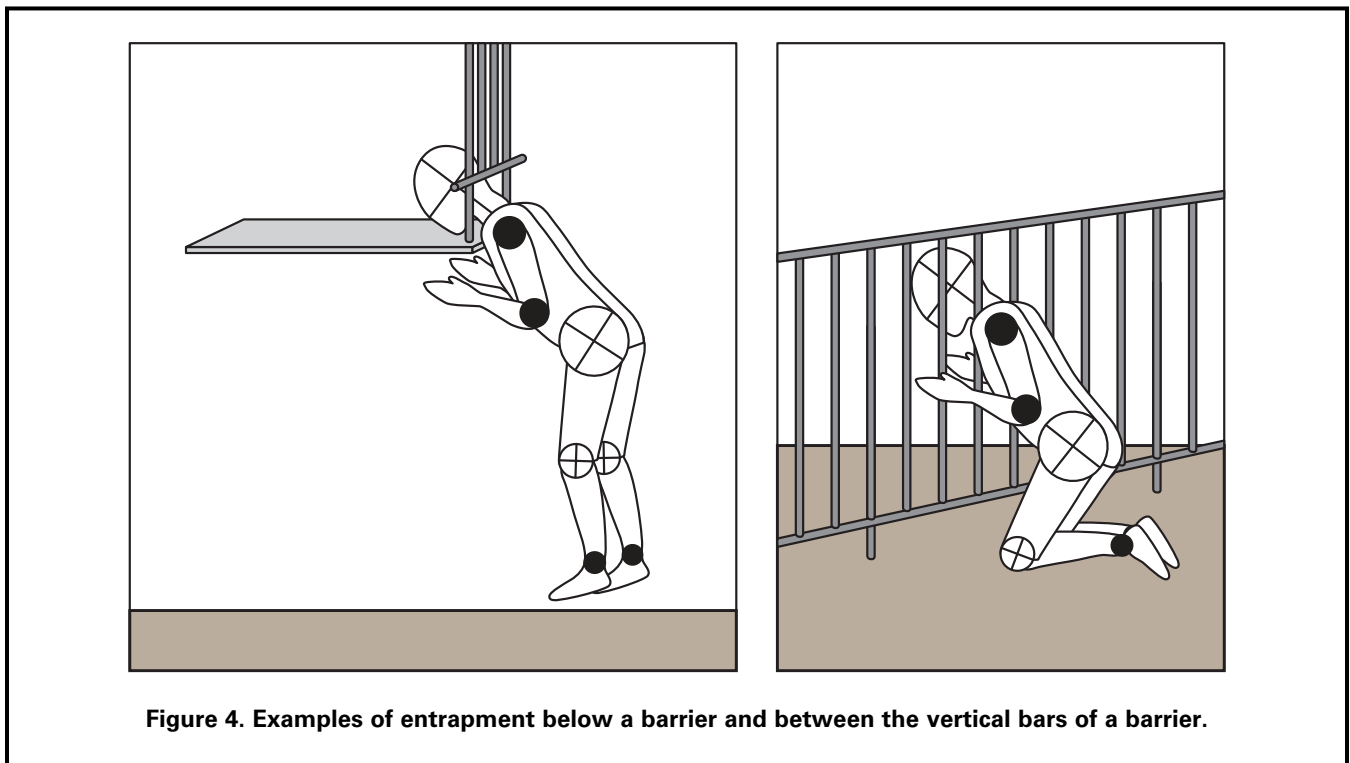

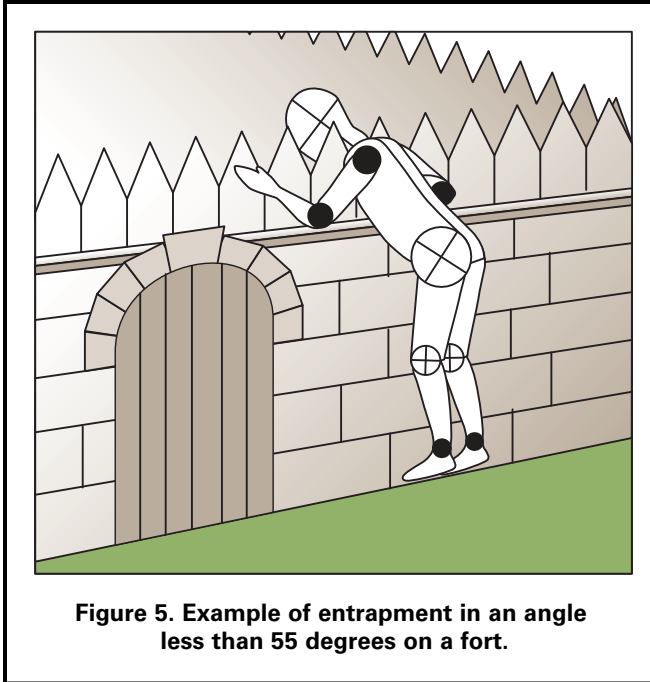

**Figure 5. Example of entrapment in an angle less than 55 degrees on a fort.**

### 3.3.2 Partially bound openings and angles

Children can become entrapped by partially bound openings, such as those formed by two or more playground parts.

- Angles formed by two accessible adjacent parts should be greater than 55 degrees unless the lowest leg is horizontal or below horizontal.
- Use the partially-bound opening test in Appendix B to identify hazardous angles and other partially-bound openings.

### 3.4 Sharp Points, Corners, and Edges

Sharp points, corners, or edges on any part of the playground or playground equipment may cut or puncture a child's skin. Sharp edges can cause serious lacerations if protective measures are not taken. To avoid the risk of injury from sharp points, corners and edges:

- Exposed open ends of all tubing not resting on the ground or otherwise covered should be covered by caps or plugs that cannot be removed without the use of tools.
- Wood parts should be smooth and free from splinters.
- All corners, metal and wood, should be rounded.
- All metal edges should be rolled or have rounded capping.

- There should be no sharp edges on slides. Pay special attention to metal edges of slides along the sides and at the exit (see also §5.3.6.4).
- If steel-belted radials are used as playground equipment, they should be closely examined regularly to ensure that there are no exposed steel belts/wires.
- Conduct frequent inspections to help prevent injuries caused by splintered wood, sharp points, corners, or edges that may develop as a result of wear and tear on the equipment.

### 3.5 Suspended Hazards

Children using a playground may be injured if they run into or trip over suspended components (such as cables, wires, ropes, or other flexible parts) connected from one piece of the playground equipment to another or hanging to the ground. These suspended components can become hazards when they are within 45 degrees of horizontal and are less than 7 feet above the protective surfacing. To avoid a suspended hazard, suspended components:

- Should be located away from high traffic areas.
- Should either be brightly colored or contrast with the surrounding equipment and surfacing.
- Should not be able to be looped back on themselves or other ropes, cables, or chains to create a circle with a 5 inch or greater perimeter.
- Should be fastened at both ends unless they are 7 inches or less long or attached to a swing seat.

These recommendations do not apply to swings, climbing nets, or if the suspended component is more than 7 feet above the protective surfacing and is a minimum of one inch at its widest cross-section dimension.

### 3.6 Tripping Hazards

Play areas should be free of tripping hazards (i.e., sudden change in elevations) to children who are using a playground. Two common causes of tripping are anchoring devices for playground equipment and containment walls for loose-fill surfacing materials.

- All anchoring devices for playground equipment, such as concrete footings or horizontal bars at the bottom of flexible climbers, should be installed below ground level

and beneath the base of the protective surfacing material. This will also prevent children from sustaining additional injuries from impact if they fall on exposed footings.

- Contrasting the color of the surfacing with the equipment color can contribute to better visibility.
- Surfacing containment walls should be highly visible.
- Any change of elevation should be obvious.
- Contrasting the color of the containment barrier with the surfacing color can contribute to better visibility.
- Steel-belted radials should be closely examined regularly to ensure that there are no exposed steel belts/wires.
- Care should be taken so that the tire does not collect water and debris; for example, providing drainage holes on the underside of the tire would reduce water collection.
- Recycled tire rubber mulch products should be inspected before installation to ensure that all metal has been removed.

In some situations, plastic materials can be used as an alternative to simulate actual automobile tires.

### **3.7 Used Tires**

Used automobile and truck tires are often recycled as playground equipment, such as tire swings or flexible climbers, or as a safety product such as cushioning under a seesaw or shredded as protective surfacing. When recycling tires for playground use:

## 4. MAINTAINING A PLAYGROUND

Inadequate maintenance of equipment has resulted in injuries on playgrounds. Because the safety of playground equipment and its suitability for use depend on good inspection and maintenance, the manufacturer’s maintenance instructions and recommended inspection schedules should be strictly followed. If manufacturer’s recommendations are not available, a maintenance schedule should be developed based on actual or anticipated playground use. Frequently used playgrounds will require more frequent inspections and maintenance.

### 4.1 Maintenance Inspections

A comprehensive maintenance program should be developed for each playground. All playground areas and equipment should be inspected for excessive wear, deterioration, and any potential hazards, such as those shown in Table 3. One possible procedure is the use of checklists. Some manufacturers supply checklists for general or detailed inspections with their maintenance instructions. These can be used to ensure that inspections are in compliance with the manufacturer’s specifications. If manufacturer-provided inspection guidelines are not available, a general checklist that may be used as a guide for frequent routine inspections of public playgrounds is included at Appendix A. This is intended to address only general maintenance concerns. Detailed inspections should give special attention to moving parts and other parts that can be expected to wear. Maintenance inspections should be carried out in a systematic manner by personnel familiar with the playground, such as maintenance workers, playground supervisors, etc.

### 4.2 Repairs

Inspections alone do not constitute a comprehensive maintenance program. Any problems found during the inspection should be noted and fixed as soon as possible.

- All repairs and replacements of equipment parts should be completed following the manufacturer’s instructions.
- User modifications, such as loose-ended ropes tied to elevated parts, should be removed immediately.
- For each piece of equipment, the frequency of thorough

**Table 3. Routine inspection and maintenance issues**

- |                          |  |
|--------------------------|--|
| <input type="checkbox"/> | Broken equipment such as loose bolts, missing end caps, cracks, etc.     |
| <input type="checkbox"/> | Broken glass & other trash   |
| <input type="checkbox"/> | Cracks in plastics   |
| <input type="checkbox"/> | Loose anchoring  |
| <input type="checkbox"/> | Hazardous or dangerous debris  |
| <input type="checkbox"/> | Insect damage  |
| <input type="checkbox"/> | Problems with surfacing  |
| <input type="checkbox"/> | Displaced loose-fill surfacing (see Section 4.3)                         |
| <input type="checkbox"/> | Holes, flakes, and/or buckling of unitary surfacing                      |
| <input type="checkbox"/> | User modifications (such as ropes tied to parts or equipment rearranged) |
| <input type="checkbox"/> | Vandalism  |
| <input type="checkbox"/> | Worn, loose, damaged, or missing parts                                   |
| <input type="checkbox"/> | Wood splitting   |
| <input type="checkbox"/> | Rusted or corroded metals  |
| <input type="checkbox"/> | Rot  |

inspections will depend on the type and age of equipment, the amount of use, and the local climate.

- Consult the manufacturer for maintenance schedules for each piece of equipment. Based on these schedules, a maintenance schedule for the entire playground can be created. This routine maintenance schedule should not replace regular inspections.

### 4.3 Maintaining Loose-Fill Surfacing

Loose-fill surfacing materials require special maintenance. High-use public playgrounds, such as child care centers and schools, should be checked frequently to ensure surfacing has not displaced significantly, particularly in areas of the playground most subject to displacement (e.g., under swings and slide exits). This can be facilitated by marking ideal surfacing depths on equipment posts. Displaced loose-fill

surfacing should be raked back into proper place so that a constant depth is maintained throughout the playground. Impact attenuating mats placed in high traffic areas, such as under swings and at slide exits, can significantly reduce displacement. They should be installed below or level with surfacing so as not to be a tripping hazard.

The following are key points to look for during regular checks of surfacing:

- Areas under swings and at slide exits. Activity in these areas tends to displace surfacing quickly. Rake loose-fill back into place.
- Pooling water on mulch surfacing. For example, wet mulch compacts faster than dry, fluffy mulch. If puddles are noticed regularly, consider addressing larger drainage issues.
- Frozen surfacing. Most loose-fill surfacing that freezes

solid no longer functions as protective surfacing. Even if the first few inches may be loose, the base layer may be frozen and the impact attenuation of the surfacing may be significantly reduced. It is recommended that children not play on the equipment under these conditions.

#### **4.4 Recordkeeping**

Records of all maintenance inspections and repairs should be retained, including the manufacturer's maintenance instructions and any checklists used. When any inspection is performed, the person performing it should sign and date the form used. A record of any accident and injury reported to have occurred on the playground should also be retained. This will help identify potential hazards or dangerous design features that should be corrected.

## 5. PARTS OF THE PLAYGROUND

### 5.1 Platforms, Guardrails and Protective Barriers

#### 5.1.1 Platforms

- Platforms should be generally flat (i.e., within  $\pm 2^\circ$  of horizontal).
- Openings in platforms should be provided to allow for drainage.
- Platforms should minimize the collection of debris.
- Platforms intended for toddlers should be no more than 32 inches from the ground.

#### 5.1.2 Stepped platforms

On some composite structures, platforms are layered or tiered so that a child may access the higher platform without steps or ladders. Unless there is an alternate means of access/egress, the maximum difference in height between stepped platforms should be:

- Toddlers: 7 inches.
- Preschool-age: 12 inches.
- School-age: 18 inches.

An access component (such as a rung) is needed if the difference in height is more than 12 inches for preschool-age and 18 inches for school-age children.

The space between the stepped platforms should follow the recommendations to minimize entrapment hazards in enclosed openings:

- Toddlers: if the space is less than 7 inches, infill should be used to reduce the space to less than 3.0 inches.
- Preschool-age: if the space exceeds 9 inches and the height of the lower platform above the protective surfacing exceeds 30 inches, infill should be used to reduce the space to less than 3.5 inches.
- School-age: if the space exceeds 9 inches and the height of the lower platform above the protective surfacing exceeds 48 inches, infill should be used to reduce the space to less than 3.5 inches.

#### 5.1.2.1 Fall height

- The fall height of a platform is the distance between the top of the platform and the protective surfacing beneath it.

#### 5.1.3 Guardrails and protective barriers

Guardrails and protective barriers are used to minimize the likelihood of accidental falls from elevated platforms. Protective barriers provide greater protection than guardrails and should be designed to discourage children from climbing over or through the barrier. Guardrails and barriers should:

- Completely surround any elevated platform.
- Except for entrance and exit openings, the maximum clearance opening without a top horizontal guardrail should be 15 inches.
- Prevent unintentional falls from the platform.
- Prevent the possibility of entrapment.
- Facilitate supervision.

For example:

- Guardrails may have a horizontal top rail with infill consisting of vertical bars having openings that are greater than 9 inches. These openings do not present an entrapment hazard but do not prevent a child from climbing through the openings.
- A barrier should minimize the likelihood of passage of a child during deliberate attempts to defeat the barrier. Any openings between uprights or between the platform surface and lower edge of a protective barrier should prevent passage of the small torso template (see test in B.2.5).

Guardrails or protective barriers should be provided on elevated platforms, walkways, landings, stairways, and transitional surfaces. In general, the younger the child, the less coordination and balance they have, therefore the more vulnerable they are to unintentional falls. Toddlers are the most vulnerable, and equipment intended for this age should use barriers on all elevated walking surfaces above 18 inches. Physical skills develop further in preschool-age children and then more with school-age children; therefore, minimum elevation recommendations for guardrails and barriers increase with each age group.



Guardrails and barriers should be high enough to prevent the tallest children from falling over the top. For guardrails, the lower edge should be low enough so that the smallest children cannot walk under it. Barriers should be low enough to prevent the smallest child from getting under the barrier in any way. This is generally done by designing the barrier so that the small torso probe (see test methods in Appendix B) cannot pass under or through the barrier. Vertical infill for protective barriers may be preferable for younger children because the vertical components can be grasped at whatever height a child chooses as a handhold.

Guardrail and barrier recommendations are shown in Table 4. However, the recommendations do not apply if the guardrail or barrier would interfere with the intended use of the equipment, such as:

- Climbing equipment
- Platforms layered so that the fall height is:
  - Toddlers: 7 inches or less.
  - Preschool-age: 20 inches or less.
  - School-age: 30 inches or less.

**Table 4. Guardrails and Barriers**

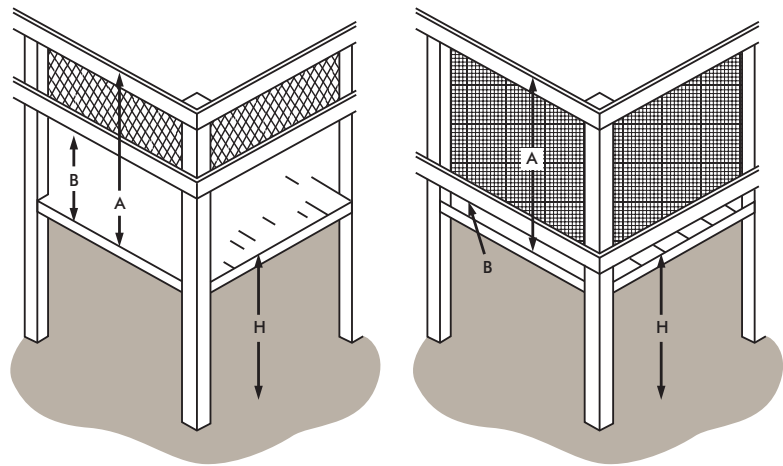

	Guardrail	Barrier
Protects against accidental falls from platform	Yes	Yes
Discourages climbing over	No	Yes
Protects against climbing through	No	Yes
<b>Toddlers</b>		
A Top edge distance from platform	Not recommended	A = 24" or higher
B Bottom edge distance from platform	Not recommended	B < 3"
H Recommended when platform fall height is:	Not recommended	H = 18" or higher
<b>Preschool-age</b>		
A Top edge distance from platform	A = 29" or higher	A = 29" or higher
B Bottom edge distance from platform	9" < B ≤ 23"	B < 3.5"
H Recommended when platform fall height is:	20" < H ≤ 30"	H > 30"
<b>School-age</b>		
A Top edge distance from platform	A = 38" or higher	A = 38" or higher
B Bottom edge distance from platform	9" < B ≤ 28"	B < 3.5"
H Recommended when platform fall height is:	30" < H ≤ 48"	H > 48"

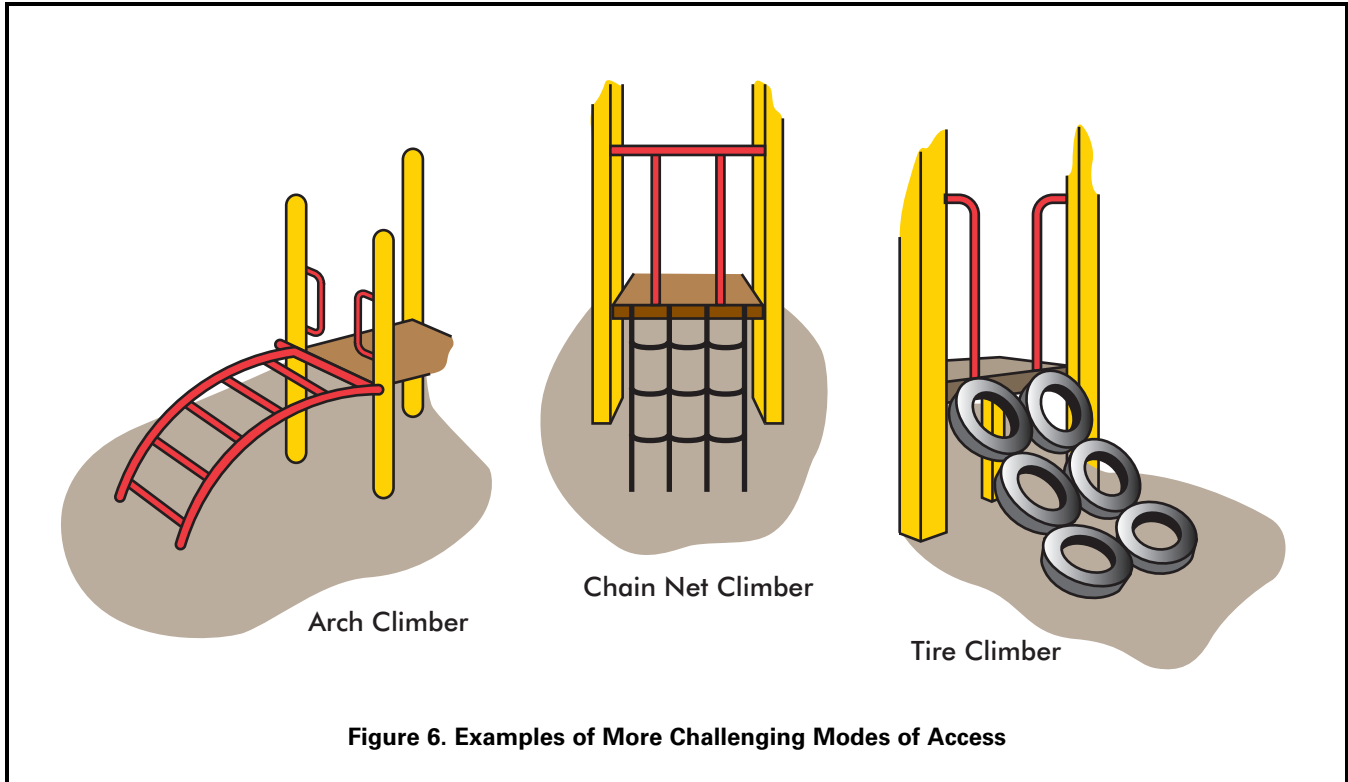

Figure 6. Examples of More Challenging Modes of Access

### 5.2 Access Methods to Play Equipment

Access to playground equipment can take many forms, such as conventional ramps, stairways with steps, and ladders with steps or rungs. Access may also be by means of climbing components, such as arch climbers, climbing nets, and tire climbers (see Figure 6).

As children develop, they gain better balance and coordination, so it is important to pick appropriate access methods based on the age group. Table 5 shows the most common methods of access and the youngest appropriate age group.

Access to platforms over 6 feet high (except for free-standing slides) should provide an intermediate standing surface so that the child can pause and make a decision to keep going up or find another way down. Children generally master access before egress, that is, they can go up before they can get back down a difficult component. Therefore, if there are more difficult access methods, it is important to have easier components for egress.

Table 5. Methods of access and egress

Method of Access	Challenge Level	Appropriate for
Ramps	Easiest	Toddlers +
Straight stairways	Easy	Toddlers +
Spiral stairways	Moderate	Toddlers* +
Step ladders	Moderate	15 months* +
Rung ladders	Moderate	Preschool* +
Arch climbers	Difficult	Preschool* +
Flexible climbers (nets, tires)	Difficult	Preschool* +
* only if an easy egress method is also provided		

**5.2.1 Ramps, stairways, rung ladders, and step ladders**

Ramps, stairways, rung ladders, and step ladders each have different recommendations for slope and tread dimension, but the steps or rungs always should be evenly spaced - even the spacing between the top step or rung and the surface of the platform. Table 6 contains recommended dimensions for: access slope; tread or rung width; tread depth; rung diameter; and vertical rise for rung ladders, step ladders, and stairways. Table 6 also contains slope and width recommendations for ramps. However, these recommendations are not intended to address ramps designed for access by wheelchairs.

- Openings between steps or rungs and between the top step or rung and underside of a platform should prevent entrapment.

- When risers are closed, treads on stairways and ladders should prevent the accumulation of sand, water, or other materials on or between steps.
- Climbing equipment should allow children to descend as easily as they ascend. One way of implementing this recommendation is to provide an easier, alternate means of descent, such as another mode of egress, a platform, or another piece of equipment. For example, a stairway can be added to provide a less challenging mode of descent than a vertical rung ladder or flexible climbing device (see Table 5).
- For toddlers and preschool-age children, offering an easy way out is particularly important since their ability to descend climbing components develops later than their ability to climb up the same components.

**Table 6. Recommended dimensions for access ladders, stairs, and ramps\***

AGE OF INTENDED USER			
Type of Access	Toddler	Preschool-age	School-age
<i>Ramps (not intended to meet ADA/ABA specifications)</i>			
Slope (vertical:horizontal)	< 1:8	≤ 1:8	≤ 1:8
Width (single)	≥ 19"	≥ 12"	≥ 16"
Width (double)	≥ 30"	≥ 30"	≥ 36"
<i>Stairways</i>			
Slope	≤ 35°	< 50°	< 50°
Tread width (single)	12-21"	≥ 12"	≥ 16"
Tread width (double)	≥ 30"	≥ 30"	≥ 36"
Tread depth (open riser)	Not appropriate	≥ 7"	≥ 8"
Tread depth (closed riser)	≥ 8"	≥ 7"	≥ 8"
Vertical rise	≤ 7"	≤ 9"	≤ 12"
<i>Step ladders</i>			
Slope	35≤65°	50-75°	50-75°
Tread width (single)	12-21"	12-21"	≥ 16"
Tread width (double)	Not appropriate	Not appropriate	≥ 36"
Tread depth (open riser)	Not appropriate	≥ 7"	≥ 3"
Tread depth (closed riser)	8"	≥ 7"	≥ 6"
Vertical rise	> 5" and ≤ 7"	≤ 9"	≤ 12"
<i>Rung ladders</i>			
Slope	Not appropriate	75-90°	75-90°
Rung width	Not appropriate	≥ 12"	≥ 16"
Vertical rise	Not appropriate	≤ 12"	≤ 12"
Rung diameter	Not appropriate	0.95-1.55"	0.95-1.55"
* entrapment recommendations apply to all openings in access components			

## 5.2.2 Rungs and other hand gripping components

Unlike steps of stairways and step ladders that are primarily for foot support, rungs can be used for both foot and hand support.

- Rungs with round shapes are easiest for children to grip.
- All hand grips should be secured in a manner that prevents them from turning.
- Toddlers:
  - Handrails or other means of hand support should have a diameter or maximum cross-section between 0.60 and 1.20 inches.
  - A diameter or maximum cross-section of 0.90 inches is preferred to achieve maximal grip strength and benefit the weakest children.
- Preschool- and school-age:
  - Rungs, handrails, climbing bars, or other means of hand support intended for holding should have a diameter or maximum cross-section between 0.95 and 1.55 inches.
  - A diameter or maximum cross-section of 1.25 inches is preferred to achieve maximal grip strength and benefit the weakest children.

## 5.2.3 Handrails

Handrails on stairways and step ladders are intended to provide hand support and to steady the user. Continuous handrails extending over the full length of the access should be provided on both sides of all stairways and step ladders, regardless of the height of the access. Rung ladders do not require handrails since rungs or side supports provide hand support on these more steeply inclined accesses.

### 5.2.3.1 Handrail height

Handrails should be available for use at the appropriate height, beginning with the first step. The vertical distance between the top front edge of a step or ramp surface and the top surface of the handrail above it should be as follows:

- Toddlers: between 15 and 20 inches.
- Preschool-age: between 22 and 26 inches.
- School-age: between 22 and 38 inches.

## 5.2.4 Transition from access to platform

Handrails or handholds are recommended at all transition points (the point where the child must move from the access component to the play structure platform).

- The handhold should provide support from the access component until the child has fully achieved the desired posture on the platform.
- Any opening between a handrail and an adjacent vertical structure (e.g., vertical support post for a platform or vertical slat of a protective barrier) should not pose an entrapment hazard.
- Access methods that do not have handrails, such as rung ladders, flexible climbers, arch climbers, and tire climbers, should provide hand supports for the transition between the top of the access and the platform.

## 5.3 Major Types of Playground Equipment

### 5.3.1 Balance beams

- Balance beams should be no higher than:
  - Toddlers: not recommended.
  - Preschool-age: 12 inches.
  - School-age: 16 inches.

#### 5.3.1.1 Fall height

The fall height of a balance beam is the distance between the top of the walking surface and the protective surfacing beneath it.

### 5.3.2 Climbing and upper body equipment

Climbing equipment is generally designed to present a greater degree of physical challenge than other equipment on public playgrounds. This type of equipment requires the use of the hands to navigate up or across the equipment. “Climbers” refers to a wide variety of equipment, such as but not limited to:

- Arch climbers
- Dome climbers
- Flexible climbers (usually chain or net)
- Parallel bars
- Sliding poles



Simple Arch Climber



Geodesic Dome Climber



Overhead Horizontal Ladder



Overhead Loop Ladder

**Figure 7. Examples of climbers**

- Spiral climbers
- Upper body equipment (horizontal overhead ladders, overhead rings, track ride).

School-age children tend to use climbing and upper body equipment more frequently and more proficiently than preschool children. Young preschool children may have difficulty using some climbers because they have not yet developed some of the physical skills necessary for certain climbing activities (balance, coordination, and upper body strength). Older preschool children (i.e., 4- and 5-year-olds) are beginning to use flexible climbers, arch climbers, and upper body devices.

### 5.3.2.1 Design considerations

#### 5.3.2.1.1 Layout of climbing components

When climbing components are part of a composite structure, their level of challenge and method of use should be compatible with the traffic flow from nearby components. Upper body devices should be placed so that the swinging movement generated by children on this equipment cannot interfere with the movement of children on adjacent structures, particularly children descending on slides. The design of adjacent play structures should not facilitate climbing to the top support bars of upper body equipment.

#### 5.3.2.1.2 Fall Height

Climbers:

- Unless otherwise specified in this section, the fall height for climbers is the distance between the highest part of the climbing component and the protective surfacing beneath it.
- If the climber is part of a composite structure, the fall height is the distance between the highest part of the climber intended for foot support and the protective surfacing beneath it.
  - Toddlers: The maximum fall height for free standing and composite climbing structures should be 32 inches.

Upper Body Equipment:

- The fall height of upper body equipment is the distance between the highest part of the equipment and the protective surface below.

#### 5.3.2.1.3 Climbing rungs

Some of the access methods discussed in §5.2 are also considered climbing devices; therefore, the recommendations for the size of climbing rungs are similar.

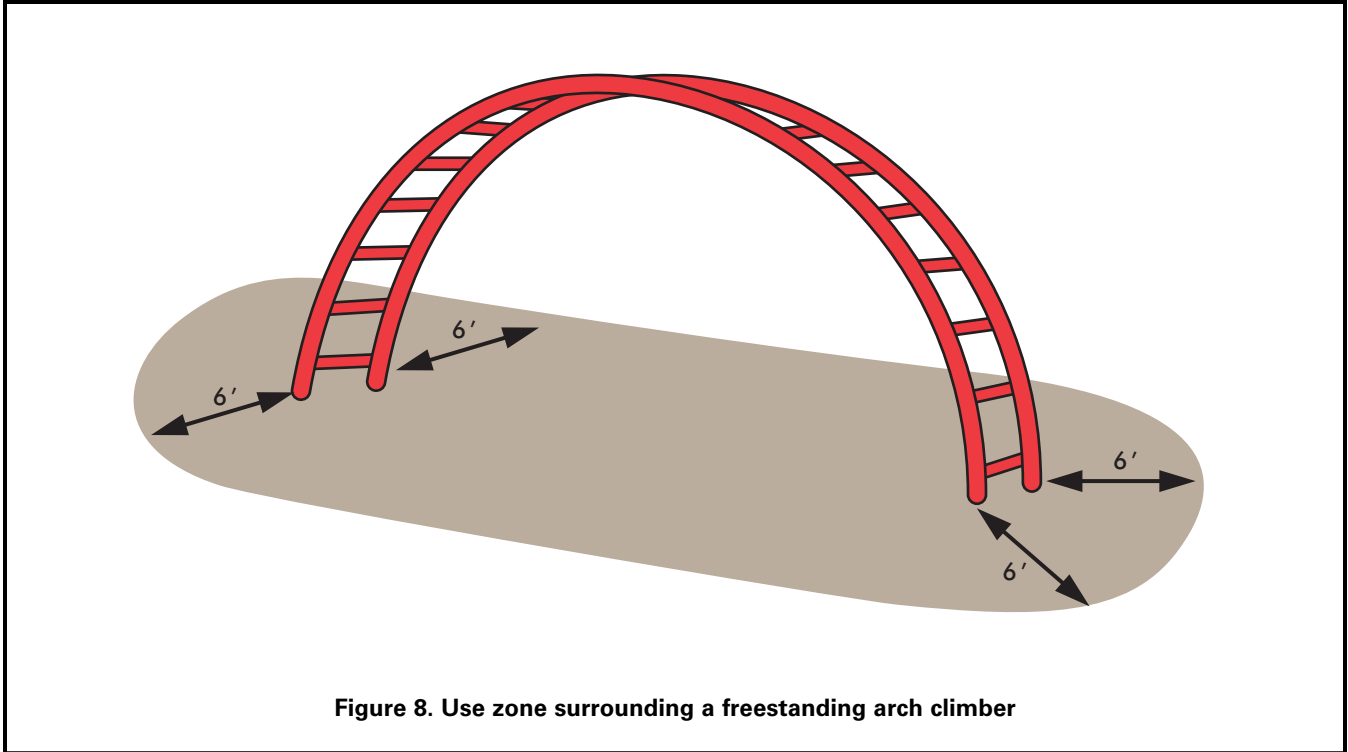

**Figure 8. Use zone surrounding a freestanding arch climber**

- Rungs should be generally round.
- All rungs should be secured in a manner that prevents them from turning.
- Climbing rungs should follow the same diameter recommendations as in §5.2.2.

**5.3.2.1.4 Use zone**

- The use zone should extend a minimum of 6 feet in all directions from the perimeter of the stand alone climber. See Figure 8.
- The use zone of a climber may overlap with neighboring equipment if the other piece of equipment allows overlapping use zones and
  - There is at least 6 feet between equipment when adjacent designated play surfaces are no more than 30 inches high; or
  - There is at least 9 feet between equipment when adjacent designated play surfaces are more than 30 inches high.

**5.3.2.1.5 Other considerations**

- Climbers should not have climbing bars or other rigid structural components in the interior of the climber onto

which a child may fall from a height of greater than 18 inches. See Figure 9 for an example of a climber that **DOES NOT** follow this consideration.

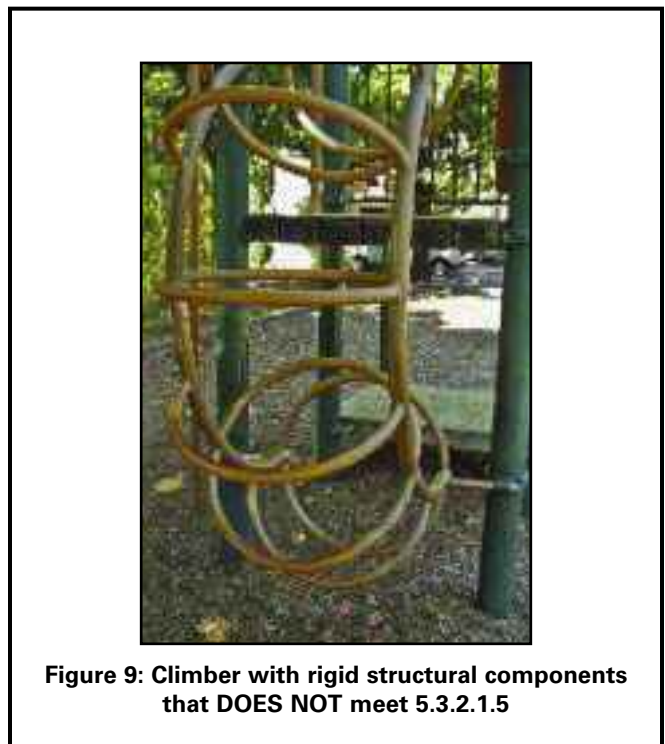
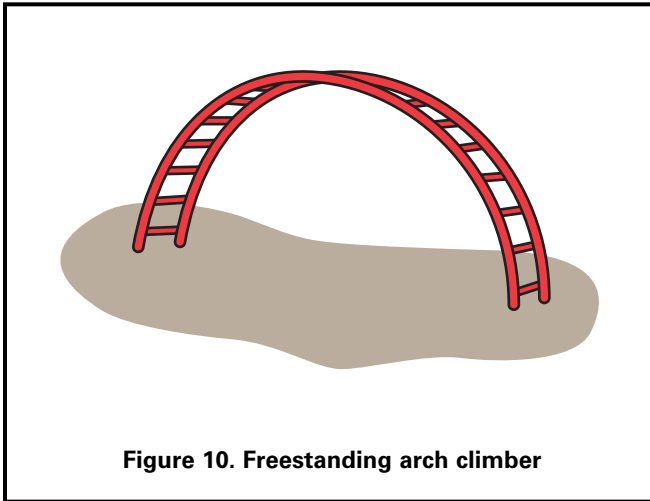

**Figure 9: Climber with rigid structural components that DOES NOT meet 5.3.2.1.5**

### 5.3.2.2 Arch climbers

Arch climbers consist of rungs attached to convex side supports. They may be free standing (Figure 10) or be provided as a more challenging means of access to other equipment (Figure 11).

- Arch climbers should not be used as the sole means of access to other equipment for preschoolers.
- Free standing arch climbers are not recommended for toddlers or preschool-age children.
- The rung diameter and spacing of rungs on arch climbers should follow the recommendations for rung ladders in Table 6.



**Figure 10. Freestanding arch climber**

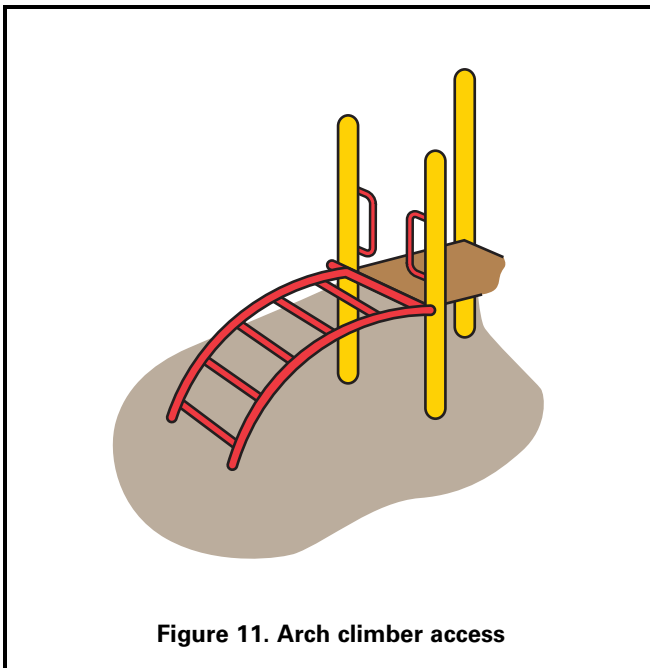

**Figure 11. Arch climber access**

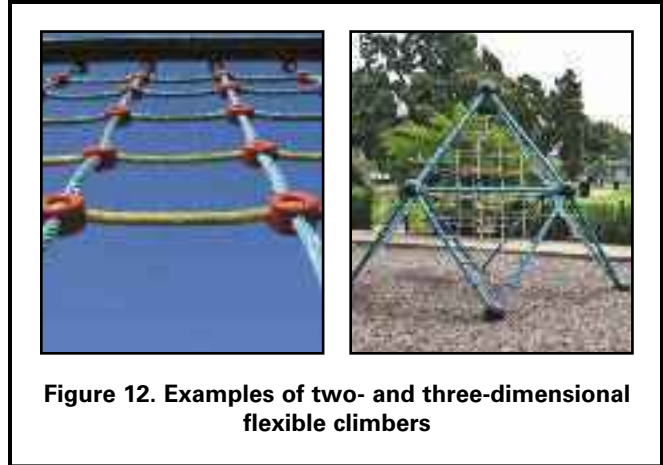

**Figure 12. Examples of two- and three-dimensional flexible climbers**

### 5.3.2.3 Flexible climbers

Flexible climbers use a grid of ropes, chains, cables, or tires for climbing. Since the flexible parts do not provide a steady means of support, flexible climbers require more advanced balance abilities than rigid climbers.

Rope, chain, and cable generally form a net-like structure that may be either two or three dimensional. See Figure 12. Tire climbers may have the tires secured tread-to-tread to form a sloping grid, or the tires may be suspended individually by chains or other means.

- Flexible climbers that provide access to platforms should be securely anchored at both ends.
- When connected to the ground, the anchoring devices should be installed below ground level and beneath the base of the protective surfacing material.
- Connections between ropes, cables, chains, or between tires should be securely fixed.
- Flexible climbers are not recommended as the sole means of access to equipment intended for toddlers and preschool-age children.
- Free-standing flexible climbers are not recommended on playgrounds intended for toddlers and preschool children.
- Spacing between the horizontal and vertical components of a climbing grid should not form entrapment hazards.
- The perimeter of any opening in a net structure should be less than 17 inches or greater than 28 inches (see Figure 13).

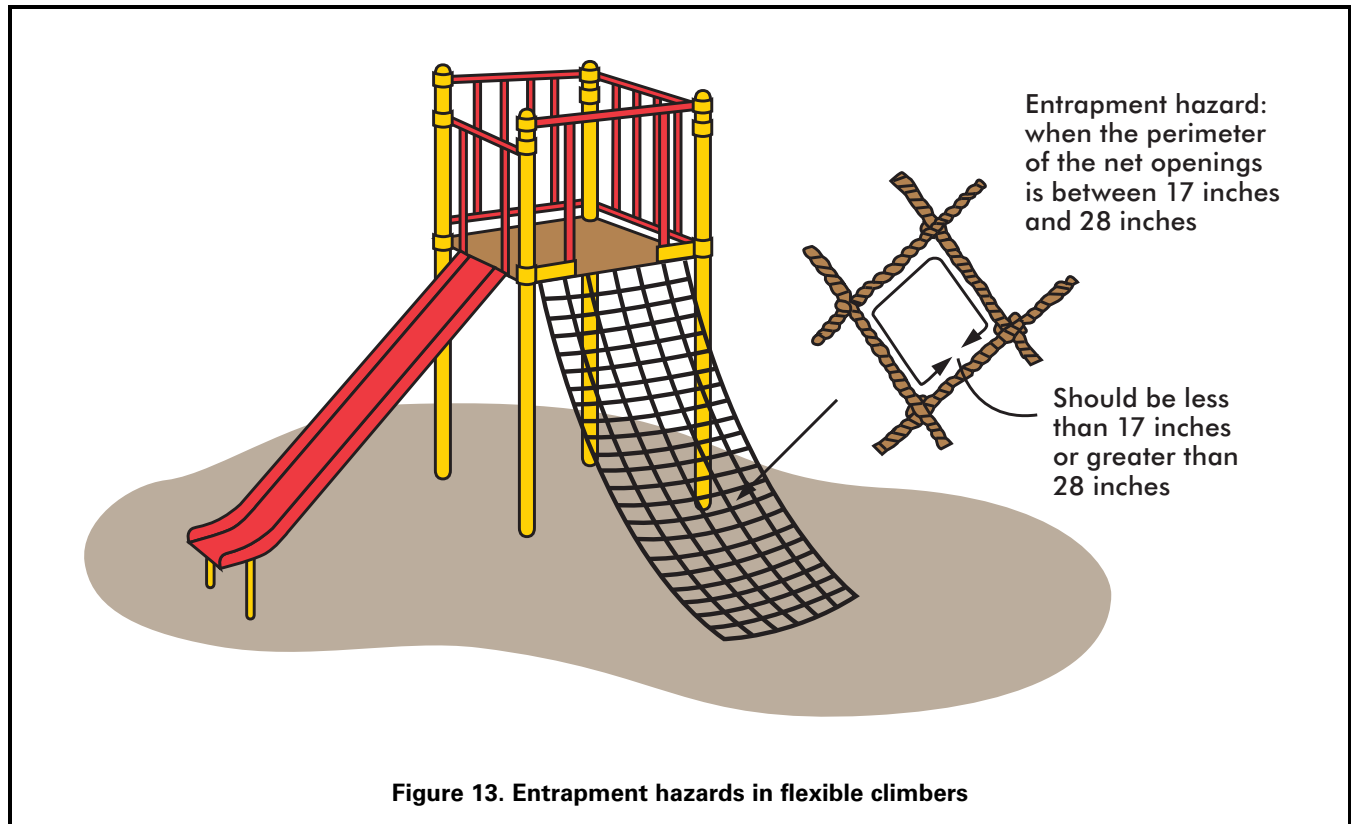

#### 5.3.2.4 Horizontal (overhead) ladders

Horizontal (overhead) ladders are a type of climber designed to build upper body strength. They are designed to allow children to move across the ladder from end to end using only their hands.

Four-year-olds are generally the youngest children able to use upper body devices like these; therefore, horizontal ladders should not be used on playgrounds intended for toddlers and 3-year-olds. The recommendations below are designed to accommodate children ages 4 through 12 years.

- The first handhold on either end of upper body equipment should not be placed directly above the platform or climbing rung used for mount or dismount. This minimizes the risk of children impacting rigid access structures if they fall from the first handhold during mount or dismount.
- The horizontal distance out to the first handhold should be:
  - No greater than 10 inches but not directly above the platform when access is from a platform.
  - At least 8 inches but no greater than 10 inches when access is from climbing rungs.
- The space between adjacent rungs of overhead ladders should be greater than 9 inches to prevent entrapment.
- Horizontal ladders intended for preschool-age children should have rungs that are parallel to one another and evenly spaced.
- The maximum height of a horizontal ladder (i.e., measured from the center of the grasping device to the top of the protective surfacing below) should be:
  - Preschool-age (4 and 5 years): no more than 60 inches.
  - School-age: no more than 84 inches.
- The center-to-center spacing of horizontal ladder rungs should be as follows:
  - Preschool-age (4 and 5 years): no more than 12 inches.
  - School-age: no more than 15 inches.
- The maximum height of the take-off/landing platform above the protective surfacing should be:
  - Preschool-age (4 and 5 years): no more than 18 inches.
  - School-age: no more than 36 inches.



### 5.3.2.5 Overhead rings

Overhead rings are similar to horizontal ladders in terms of the complexity of use. Therefore, overhead rings should not be used on playgrounds intended for toddlers and 3-year-olds. The recommendations below are designed to accommodate children 4 through 12 years of age.

Overhead rings differ from horizontal ladders because, during use, the gripped ring swings through an arc and reduces the distance to the gripping surface of the next ring; therefore, the spacing distance recommendations for horizontal ladders do not apply.

- The first handhold on either end of upper body equipment should not be placed directly above the platform or climbing rung used for mount or dismount. This minimizes the risk of children hitting rigid access structures if they fall from the first handhold during mount or dismount.
- The horizontal distance out to the first handhold should be:
  - No greater than 10 inches but not directly above the platform when access is from a platform.
  - At least 8 inches but no greater than 10 inches when access is from climbing rungs.
- The maximum height of overhead rings measured from the center of the grasping device to the protective surfacing should be:
  - Preschool-age (4 and 5 years): 60 inches.
  - School-age: 84 inches.
- If overhead swinging rings are suspended by chains, the maximum length of the chains should be 7 inches.
- The maximum height of the take-off/landing platform above the protective surfacing should be:
  - Preschool-age (4 and 5 years): no more than 18 inches.
  - School-age: no more than 36 inches.

### 5.3.2.6 Sliding poles

Vertical sliding poles are more challenging than some other types of climbing equipment. They require upper body strength and coordination to successfully slide down the pole. Unlike other egress methods, there is no reverse or stop, so a child cannot change his or her mind. Children who start a sliding pole must have the strength to slide the whole way or they will fall.

- Sliding poles are not recommended for toddlers or preschool-age children since they generally don't have the upper body and/or hand strength to slide.

- Sliding poles should be continuous with no protruding welds or seams along the sliding surface.
- The pole should not change direction along the sliding portion.
- The horizontal distance between a sliding pole and any structure used for access to the sliding pole should be between 18 inches and 20 inches.
- The pole should extend at least 60 inches above the level of the platform or structure used for access to the sliding pole.
- The diameter of sliding poles should be no greater than 1.9 inches.
- Sliding poles and their access structures should be located so that traffic from other events will not interfere with the users during descent.
- Upper access should be on one level only.
- The upper access area through the guardrail or barrier should be 15 inches wide at most.

#### 5.3.2.6.1 Fall height

- For sliding poles accessed from platforms, the fall height is the distance between the platform and the protective surfacing beneath it.
- For sliding poles not accessed from platforms, the fall height is the distance between a point 60 inches below the highest point of the pole and the protective surfacing beneath it.
- The top of the sliding pole's support structure should not be a designated play surface.

### 5.3.2.7 Track rides

Track rides are a form of upper body equipment where the child holds on to a handle or other device that slides along a track above his or her head. The child then lifts his or her feet and is carried along the length of the track. Track rides require significant upper body strength and the judgment to know when it is safe to let go. These are skills not developed until children are at least school-age; therefore, CPSC staff recommends:

- Track rides should not be used on playgrounds for toddlers and preschool-age children.
- Track rides should not have any obstacles along the path of the ride, including anything that would interfere in the take-off or landing areas.

- Two track rides next to each other should be at least 4 feet apart.
- The handle should be between 64 inches and 78 inches from the surfacing and follow the gripping recommendations in §5.2.2.
- Nothing should ever be tied or attached to any moving part of a track ride.
- Rolling parts should be enclosed to prevent crush hazards.

#### 5.3.2.7.1 Fall height

- The fall height of track ride equipment is the distance between the maximum height of the equipment and the protective surface beneath it.
- Equipment support posts with no designated play surfaces are exempt from this requirement.

### 5.3.3 Log rolls

Log rolls help older children master balance skills and increase strength. Children must balance on top of the log as they spin it with their feet. See Figure 14.

- Log rolls are not recommended for toddlers and preschool-age children. These children generally do not possess the balance, coordination, and strength to use a log roll safely.
- Log rolls should have handholds to assist with balance.
- The handholds should follow the guidelines in §5.2.2.
- The highest point of the rolling log should be a maximum of 18 inches above the protective surface below.
- When not part of a composite structure, the use zone may overlap with neighboring equipment if the other piece of equipment allows overlapping use zones (see §5.3.9) and
  - There is at least 6 feet between equipment when adjacent designated play surfaces are no more than 30 inches high; or
  - There is at least 9 feet between equipment when adjacent designated play surfaces are more than 30 inches high.

#### 5.3.3.1.1 Fall height

The fall height of a log roll is the distance between the highest portion of the rolling log and the protective surfacing beneath it.



Figure 14. Log roll

### 5.3.4 Merry-go-rounds

Merry-go-rounds are the most common rotating equipment found on public playgrounds. Children usually sit or stand on the platform while other children or adults push the merry-go-round to make it rotate. In addition, children often get on and off the merry-go-round while it is in motion. Merry-go-rounds may present a physical hazard to preschool-age children who have little or no control over such products once they are in motion. Therefore, children in this age group should always be supervised when using merry-go-rounds.

The following recommendations apply when the merry-go-round is at least 20 inches in diameter.

- Merry-go-rounds should not be used on playgrounds intended for toddlers.
- The standing/sitting surface of the platform should have a maximum height of:
  - Preschool: 14 inches above the protective surface.
  - School-age: 18 inches above the protective surface.
- The rotating platform should be continuous and approximately circular.
- The surface of the platform should not have any openings between the axis and the periphery that permit a rod having a diameter of 5/16 inch to penetrate completely through the surface.

- The difference between the minimum and maximum radii of a non-circular platform should not exceed 2.0 inches (Figure 15).

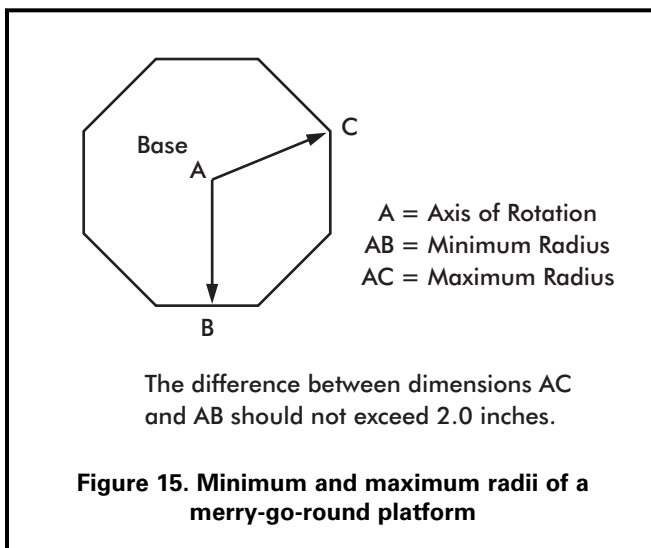

- The underside of the perimeter of the platform should be no less than 9 inches above the level of the protective surfacing beneath it.
- There should not be any accessible shearing or crushing mechanisms in the undercarriage of the equipment.
- Children should be provided with a secure means of holding on. Where handgrips are provided, they should conform to the general recommendations for hand gripping components in §5.2.2.
- No components of the apparatus, including handgrips, should extend beyond the perimeter of the platform.
- The rotating platform of a merry-go-round should not have any sharp edges.
- A means should be provided to limit the peripheral speed of rotation to a maximum of 13 ft/sec.
- Merry-go-round platforms should not have any up and down (oscillatory) motion.

#### 5.3.4.1 Use zone

- The use zone should extend a minimum of 6 feet beyond the perimeter of the platform.
- The use zone may not overlap other use zones, unless the rotating equipment is less than 20 inches in diameter and the adjacent equipment allows overlap.

#### 5.3.4.2 Fall height

The fall height for a merry-go-round is the distance between the perimeter of the platform where a child could sit or stand and the protective surfacing beneath it.

#### 5.3.5 Seesaws

##### 5.3.5.1 Fulcrum seesaws

The typical seesaw (also known as a “teeter totter”) consists of a board or pole with a seat at each end supported at the center by a fulcrum. See Figure 16. Because of the complex way children are required to cooperate and combine their actions, fulcrum seesaws are not recommended for toddlers or preschool-age children.

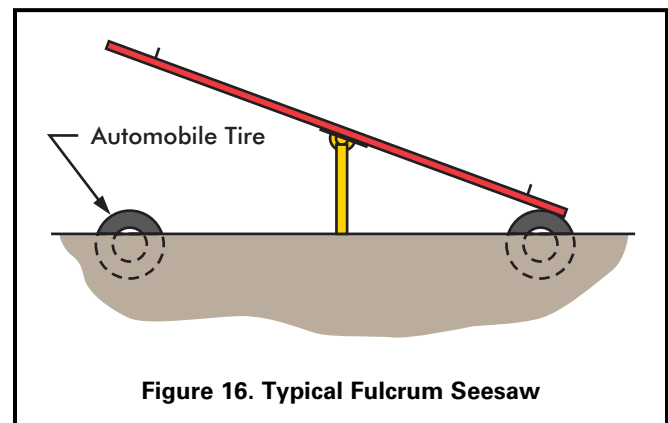

- The fulcrum should not present a crush hazard.
- Partial car tires, or some other shock-absorbing material, should be embedded in the ground underneath the seats, or secured on the underside of the seats. This will help prevent limbs from being crushed between the seat and the ground, as well as cushion the impact.
- The maximum attainable angle between a line connecting the seats and the horizontal is 25°.
- There should not be any footrests.

##### 5.3.5.2 Spring-centered seesaws

Preschool-age children are capable of using spring-centered seesaws because the centering device prevents abrupt contact with the ground if one child dismounts suddenly. Spring-centered seesaws also have the advantage of not requiring two children to coordinate their actions in order to play safely. Spring-centered seesaws should follow the recommendations for spring rockers including the use of footrests (§5.3.7).

### 5.3.5.3 Use zone for fulcrum and spring-centered seesaws

- The use zone should extend a minimum of 6 feet from each outside edge of the seesaw.
- The use zone may overlap with neighboring equipment if the other piece of equipment allows overlapping use zones and
  - There is at least 6 feet between equipment when adjacent designated play surfaces are no more than 30 inches high; or
  - There is at least 9 feet between equipment when adjacent designated play surfaces are more than 30 inches high.

### 5.3.5.4 Handholds

- Handholds should be provided at each seating position for gripping with both hands and should not turn when grasped.
- Handholds should not protrude beyond the sides of the seat.

### 5.3.5.5 Fall height

The fall height for a seesaw is the distance between the highest point any part of the seesaw can reach and the protective surfacing beneath it.

### 5.3.6 Slides

Children can be expected to descend slide chutes in many different positions, rather than always sitting and facing forward as they slide. These other positions should be discouraged at all times to minimize injuries.



Slides may provide a straight, wavy, or spiral descent either by means of a tube or an open slide chute. They may be either free-standing (Figure 17), part of a composite structure, or built on the grade of a natural or man-made slope (embankment slide). Regardless of the type of slide, avoid using bare metals on the platforms, chutes, and steps. When exposed to direct sunlight the bare metal may reach temperatures high enough to cause serious contact burn injuries in a matter of seconds. Provide shade for bare metal slides or use other materials that may reduce the surface temperature such as, but not limited to, plastic or coated metal.

#### 5.3.6.1 Slide access

Access to a stand-alone slide generally is by means of a ladder with rungs, steps, or a stairway with steps. Slides may also be part of a composite play structure, so children will gain access from other parts of the structure. Embankment slides use the ground for access.

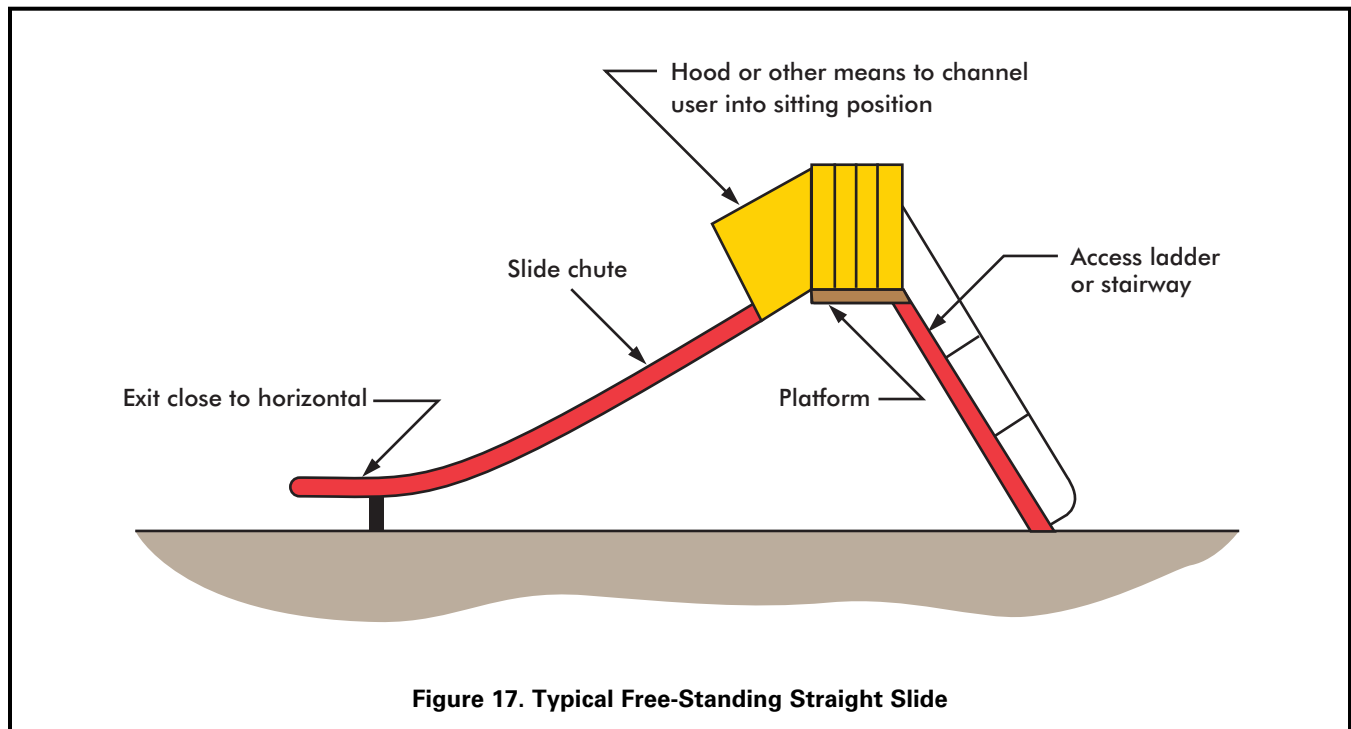

Figure 17. Typical Free-Standing Straight Slide

### 5.3.6.2 Slide platform

All slides should be provided with a platform with sufficient length to facilitate the transition from standing to sitting at the top of the inclined sliding surface. Embankment slides are exempt from platform requirements because they are on ground level; however, they should not have any spaces or gaps as noted below.

The platform should:

- Be at least 19 inches deep for toddlers.
- Be at least 14 inches deep for preschool-age and school-age children.
- Be horizontal.
- Be at least as wide as the slide chute.
- Be surrounded by guardrails or barriers.
- Conform to the same recommendations as general platforms given in §5.1.1.
- Not have any spaces or gaps that could trap strings, clothing, body parts, etc. between the platform and the start of the slide chute.
- Provide handholds to facilitate the transition from standing to sitting and decrease the risk of falls (except tube slides where the tube perimeter provides hand support). These should extend high enough to provide hand support for the largest child in a standing position, and low enough to provide hand support for the smallest child in a sitting position.
- Provide a means to channel a user into a sitting position at the entrance to the chute, such as a guardrail, hood, or other device that discourages climbing.

### 5.3.6.3 Slide chutes

#### 5.3.6.3.1 Embankment slides

- The slide chute of an embankment slide should have a maximum height of 12 inches above the underlying ground surface. This design basically eliminates the hazard of falls from elevated heights.
- Embankment slides should follow all of the recommendations given for straight slides where applicable (e.g., side height, slope, use zone at exit, etc.).
- There should be some means provided at the slide chute entrance to minimize the use of embankment slides by children on skates, skateboards, or bicycles.

#### 5.3.6.3.2 Roller slides

- Roller slides should meet applicable recommendations for other slides (e.g., side height, slope, use zone at exit, etc.).
- The space between adjacent rollers and between the ends of the rollers and the stationary structure should be less than 3/16 inch.
- Frequent inspections are recommended to insure that there are no missing rollers or broken bearings and that the rollers roll.

#### 5.3.6.3.3 Spiral slides

- Spiral slides should follow the recommendations for straight slides where applicable (e.g., side height, slope, use zone at exit, etc.).
- Special attention should be given to design features which may present problems unique to spiral slides, such as lateral discharge of the user.
- Toddlers and preschool-age children have less ability to maintain balance and postural control, so only short spiral slides (one 360° turn or less) are recommended for these age groups.

#### 5.3.6.3.4 Straight slides

- Flat open chutes should have sides at least 4 inches high extending along both sides of the chute for the entire length of the inclined sliding surface.
- The sides should be an integral part of the chute, without any gaps between the sides and the sliding surface. (This does not apply to roller slides).
- Slides may have an open chute with a circular, semicircular or curved cross section provided that:
  - A. The vertical height of the sides is no less than 4 inches when measured at right angles to a horizontal line that is 8 inches long when the slide is intended for toddlers, 12 inches long when the slide is intended for preschool-age children, and 16 inches long when the slide is intended for school-age children (Figure 18); or
  - B. For any age group, the vertical height of the sides is no less than 4 inches minus two times the width of the slide chute divided by the radius of the slide chute curvature (Figure 19).

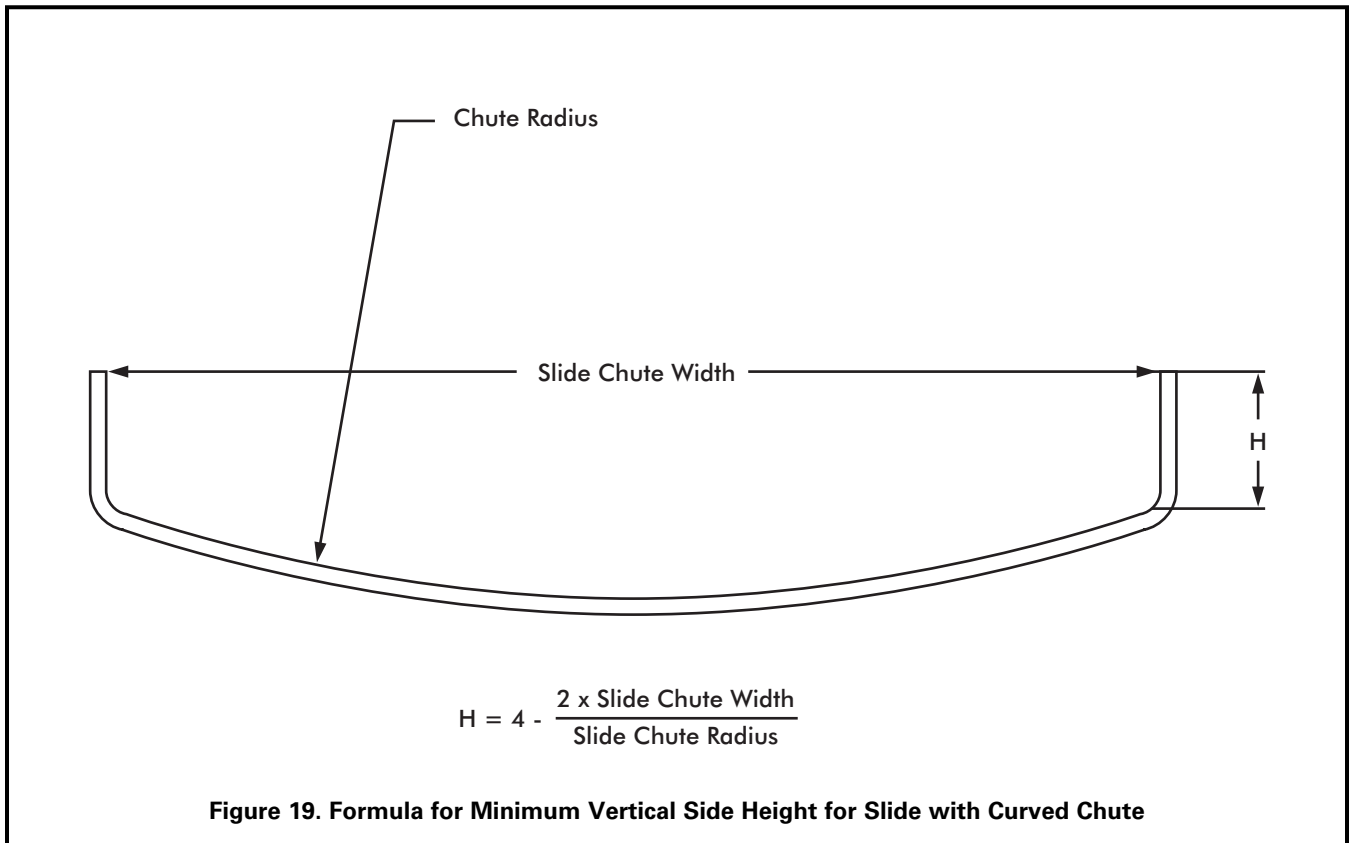
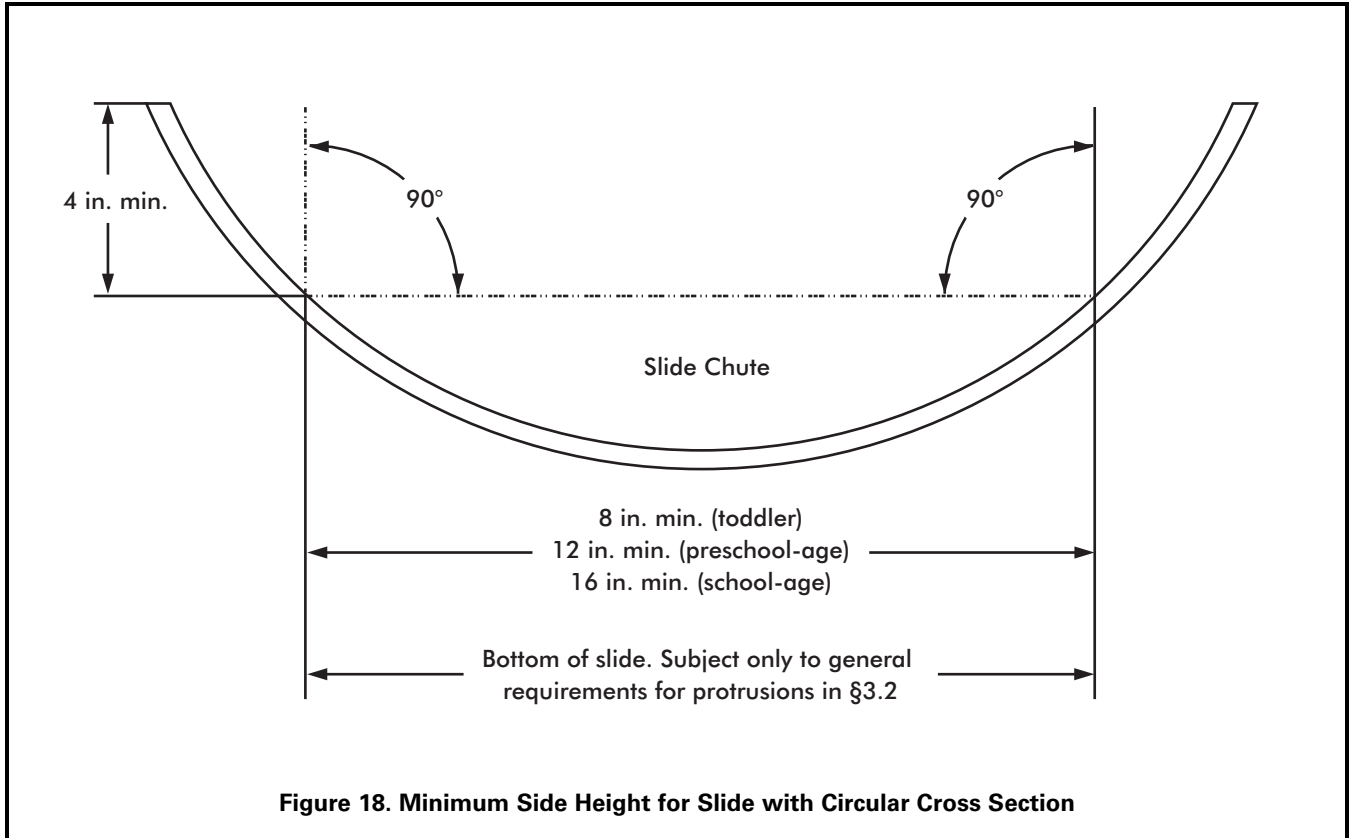

- For toddlers:
  - The average incline of a slide chute should be no more than  $24^\circ$  (that is, the height to horizontal length ratio shown in Figure 20 does not exceed 0.445).
  - No section of the slide chute should have a slope greater than  $30^\circ$ .
  - The slide chute should be between 8 and 12 inches wide.
- For preschool- and school-age children:
  - The average incline of a slide chute should be no more than  $30^\circ$  (that is, the height to horizontal length ratio shown in Figure 20 does not exceed 0.577).
  - No section of the slide chute should have a slope greater than  $50^\circ$ .

#### 5.3.6.3.5 Tube slides

- Tube slides should meet all the applicable recommendations for other slides (e.g., side height, slope, use zone at exit, etc.).
- Means, such as barriers or textured surfaces, should be provided to prevent sliding or climbing on the top (outside) of the tube.
- The minimum internal diameter of the tube should be no less than 23 inches.
- Supervisors should be aware of children using tube slides since the children are not always visible.

#### 5.3.6.4 Chute exit region

All slides should have an exit region to help children maintain their balance and facilitate a smooth transition from sitting to standing when exiting. The chute exit region should:

- Be between  $0$  and  $-4^\circ$  as measured from a plane parallel to the ground.
- Have edges that are rounded or curved to prevent lacerations or other injuries that could result from impact with a sharp or straight edge.
- For toddlers the chute exit region should:
  - Be between 7 and 10 inches long if any portion of the chute exceeds a  $24^\circ$  slope.
  - Be no more than 6 inches above the protective surfacing.
  - Have a transition from the sliding portion to the exit region with a radius of curvature of at least 18 inches.
- For preschool- and school-age the chute exit region should:
  - Be at least 11 inches long.
  - Be no more than 11 inches above the protective surfacing if the slide is no greater than 4 feet high.
  - Be at least 7 inches but not more than 15 inches above the protective surfacing if the slide is over 4 feet high.

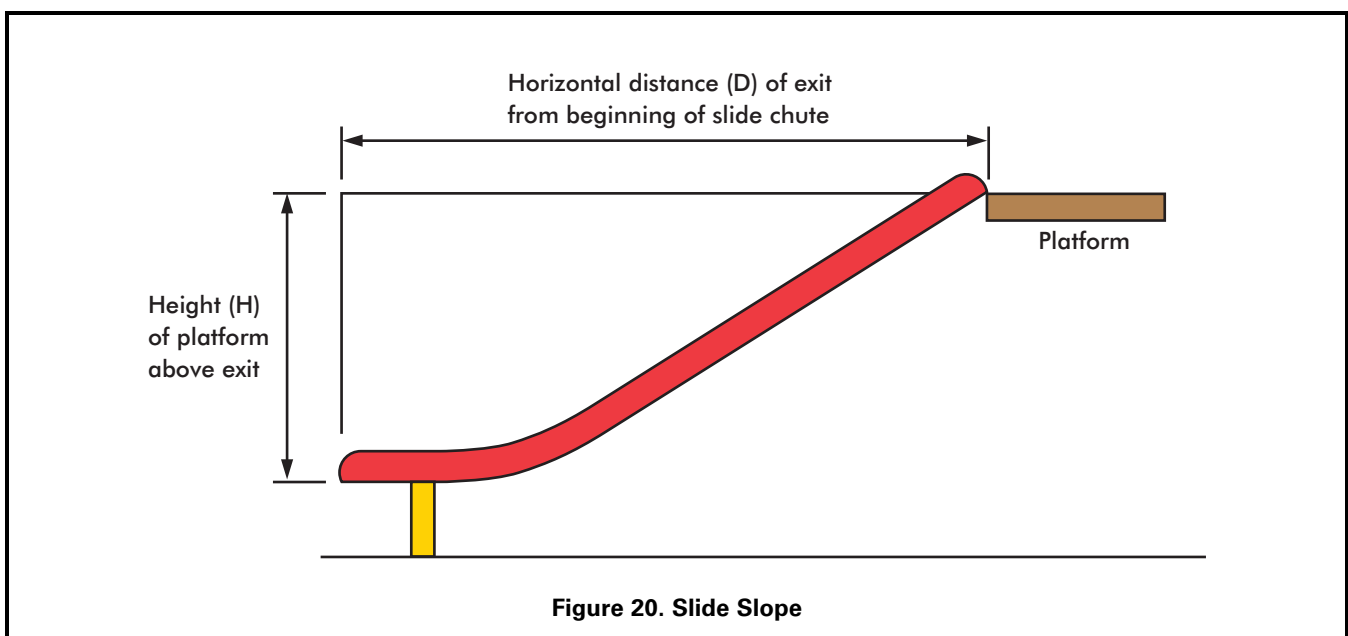

Figure 20. Slide Slope

### 5.3.6.5 Slide use zone

#### Toddlers:

- In a limited access environment
  - The use zone should be at least 3 feet around the perimeter of the slide.
  - The area at the end of the slide should not overlap with the use zone for any other equipment.
- In public areas with unlimited access
  - For a stand-alone slide, the use zone should be at least 6 feet around the perimeter.
  - For slides that are part of a composite structure, the minimum use zone between the access components and the side of the slide chute should be 3 feet.
  - The use zone at the end of the slide should be at least 6 feet from the end of the slide and not overlap with the use zone for any other equipment.

#### Preschool- and school-age (see Figure 21):

- The use zone in front of the access and to the sides of a slide should extend a minimum of 6 feet from the perimeter of the equipment. This recommendation does not apply to embankment slides or slides that are part of a composite structure (see §5.3.9).
- The use zone in front of the exit of a slide should never overlap the use zone of any other equipment; however, two or more slide use zones may overlap if their sliding paths are parallel.
- For slides less than or equal to 6 feet high, the use zone in front of the exit should be at least 6 feet.
- For slides greater than 6 feet high, the use zone in front of the exit should be at least as long as the slide is high up to a maximum of 8 feet.

### 5.3.6.6 Fall height

The fall height for slides is the distance between the transition platform and the protective surfacing beneath it.

### 5.3.6.7 Entanglement hazard

Children have suffered serious injuries and died by getting parts of their clothing tangled on protrusions or gaps on slides.

To reduce the chance of clothing entanglement:

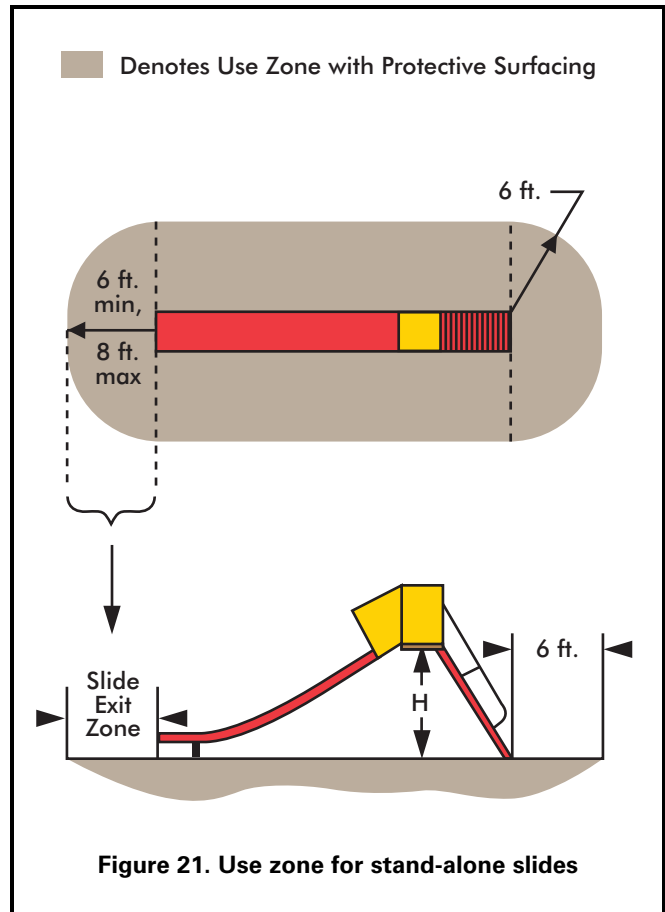

Figure 21. Use zone for stand-alone slides

- Projections up to 3 inches in diameter should not stick up more than 1/8 inch from the slide.
- There should be no gaps at the tops of slides where the slide chute connects with the platform that can entangle clothing or strings.
- See Appendix B for full recommendations and details of the protrusion test procedure.

### 5.3.6.8 Other sliding equipment

Equipment where it is foreseeable that a primary use of the component is sliding should follow the same guidelines for entanglement that are in 5.3.6.7.

### 5.3.7 Spring rockers

Toddlers and preschool-age children enjoy the bouncing and rocking activities presented by spring rockers, and they are the primary users of rocking equipment. See Figure 22. Older children may not find it challenging enough.

- Seat design should not allow the rocker to be used by more than the intended number of users.





**Figure 22. Example of spring rocker**

- For toddlers:
  - The seat should be between 12 and 16 inches high.
  - Spring rockers with opposing seats intended for more than one child should have at least 37 inches between the seat centers.
- For preschoolers:
  - The seat should be between 14 and 28 inches high.
- Each seating position should be equipped with handgrips and footrests. The diameter of handgrips should follow the recommendations for hand gripping components in §5.2.2.
- The springs of rocking equipment should minimize the possibility of children crushing their hands or their feet between coils or between the spring and a part of the rocker.
- The use zone should extend a minimum of 6 feet from the “at rest” perimeter of the equipment.
- The use zone may overlap with neighboring equipment if the other piece of equipment allows overlapping use zones and
  - There is at least 6 feet between equipment when adjacent designated play surfaces are no more than 30 inches high; or

- There is at least 9 feet between equipment when adjacent designated play surfaces are more than 30 inches high; and
- The spring rocker is designed to be used from a seated position.

### 5.3.7.1 Fall height

The fall height of spring rockers is the distance between either (1) the highest designated playing surface or (2) the seat, whichever is higher, and the protective surfacing beneath it.

### 5.3.8 Swings

Children of all ages generally enjoy the sensations created while swinging. Mostly they sit on the swings; however, it is common to see children jumping off swings. Younger children also tend to swing on their stomachs, and older children may stand on the seats. To prevent injuries, these behaviors should be discouraged.

Swings may be divided into two distinct types:

- Single axis: Sometimes called a to-fro swing. A single-axis swing is intended to swing back and forth in a single plane and generally consists of a seat supported by at least two suspending members, each of which is connected to a separate pivot on an overhead structure.
- Multi-axis: A multi-axis swing consists of a seat (generally a tire) suspended from a single pivot that permits it to swing in any direction.

#### 5.3.8.1 General swing recommendations

- Hardware used to secure the suspending elements to the swing seat and to the supporting structure should not be removable without the use of tools.
- S-hooks are often part of a swing’s suspension system, either attaching the suspending elements to the overhead support bar or to the swing seat. Open S-hooks can catch a child’s clothing and present a strangulation hazard. S-hooks should be pinched closed. An S-hook is considered closed if there is no gap or space greater than 0.04 inches (about the thickness of a dime).
- Swings should be suspended from support structures that discourage climbing.
- A-frame support structures should not have horizontal cross-bars.

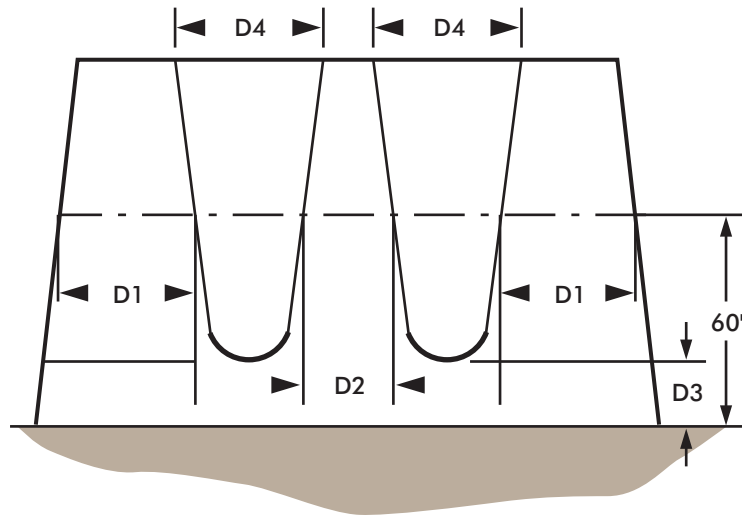

Figure 23. Minimum Clearances for Single-Axis Swings

Table 7. Minimum clearance dimensions for swings

Reason	Dimension	Toddler Full bucket	Preschool-age Belt	School-age Belt
Minimizes collisions between a swing and the supporting structure	D1	20 inches	30 inches	30 inches
Minimizes collisions between swings	D2	20 inches	24 inches	24 inches
Allows access	D3	24 inches	12 inches	12 inches
Reduces side-to-side motion	D4	20 inches	20 inches	20 inches

- Fiber ropes are not recommended as a means of suspending swings since they may degrade over time.
- Swing structures should be located away from other equipment or activities to help prevent young children from inadvertently running into the path of moving swings. Additional protection can be provided by means of a low blockade such as a fence or hedge around the perimeter of the swing area. The blockade should not be an obstacle within the use zone of a swing structure or hamper supervision by blocking visibility.

### 5.3.8.2 Fall height

The fall height for swings is the vertical distance between the pivot point and the protective surfacing beneath it.

### 5.3.8.3 Single-axis swings

#### 5.3.8.3.1 Belt seats used without adult assistance

- The use zone to the front and rear of single-axis swings should never overlap the use zone of another piece of equipment.
- To minimize the likelihood of children being struck by a moving swing, it is recommended that no more than two single-axis swings be hung in each bay of the supporting structure.

- Swings should not be attached to composite structures.
- Swing seats should be designed to accommodate no more than one user at any time.
- Lightweight rubber or plastic swing seats are recommended to help reduce the severity of impact injuries. Wood or metal swing seats should be avoided.
- Edges of seats should have smoothly finished or rounded edges and should conform to the protrusion recommendations in 5.3.8.5.
- If loose-fill material is used as a protective surfacing, the height recommendations should be determined after the material has been compressed.
- The full bucket seat materials should not present a strangulation hazard, such as might be presented with a rope or chain used as part of the seat.
- Openings in swing seats should conform to the entrapment criteria in §3.3.
- Full bucket seat swings should be suspended from structures that are separate from those for other swings, or at least suspended from a separate bay of the same structure.
- Full bucket seat swings should not allow the child to enter and exit alone.
- Pivot points should be more than 47 inches but no more than 96 inches above the protective surfacing.

#### 5.3.8.3.2 Full bucket seat swings

Full bucket seat swings are similar to single-axis swings since they move in a to-fro direction. However, full bucket seat swings are intended for children under 4 years of age to use with adult assistance.

- The seats and suspension systems of these swings, including the related hardware, should follow all of the criteria for conventional single axis swings.
- Full bucket seats are recommended to provide support on all sides of a child and between the legs of the occupant (see Figure 24).



**Figure 24. Example of full bucket seat swings**

#### 5.3.8.3.3 Use zone for single-axis swings – belt and full bucket

The use zone in front of and behind the swing should be greater than to the sides of such a swing since children may deliberately attempt to exit from a single-axis swing while it is in motion. See Figure 25.

- The use zone for a belt swing should extend to the front and rear of a single-axis swing a minimum distance of twice the vertical distance from the pivot point and the top of the protective surface beneath it.
- The use zone for a full bucket swing should extend to the front and rear a minimum of twice the vertical distance from the top of the occupant's sitting surface to the pivot point.
- The use zone in front of and behind swings should never overlap with any other use zone.
- The use zone to the sides of a single-axis swing should extend a minimum of 6 feet from the perimeter of the swing. This 6-foot zone may overlap that of an adjacent swing structure or other playground equipment structure.

#### 5.3.8.4 Multi-axis (tire) swings

Tire swings are usually suspended in a horizontal orientation using three suspension chains or cables connected to a single swivel mechanism that permits both rotation and swinging motion in any axis.

- A multi-axis tire swing should not be suspended from a structure having other swings in the same bay.
- Attaching multi-axis swings to composite structures is not recommended.

- To minimize the hazard of impact, heavy truck tires should be avoided. Further, if steel-belted radials are used, they should be closely examined to ensure that there are no exposed steel belts or wires that could be a potential protrusion or laceration hazard. Plastic materials can be used as an alternative to simulate actual automobile tires. Drainage holes should be provided in the underside of the tire.
- Pay special attention to maintenance of the hanger mechanism because the likelihood of failure is higher for tire swings due to the added stress of rotational movement and multiple occupants.
- The hanger mechanisms for multi-axis tire swings should not have any accessible crush points.
- The minimum clearance between the seating surface of a tire swing and the uprights of the supporting structure should be 30 inches when the tire is in a position closest to the support structure (Figure 26).
- The minimum clearance between the bottom of the seat and the protective surface should not be less than 12 inches.

### 5.3.8.4.1 Multi-axis swing use zones

- The use zone should extend in any direction from a point directly beneath the pivot point for a minimum distance of 6 feet plus the length of the suspending members (see Figure 27). This use zone should never overlap the use zone of any other equipment.

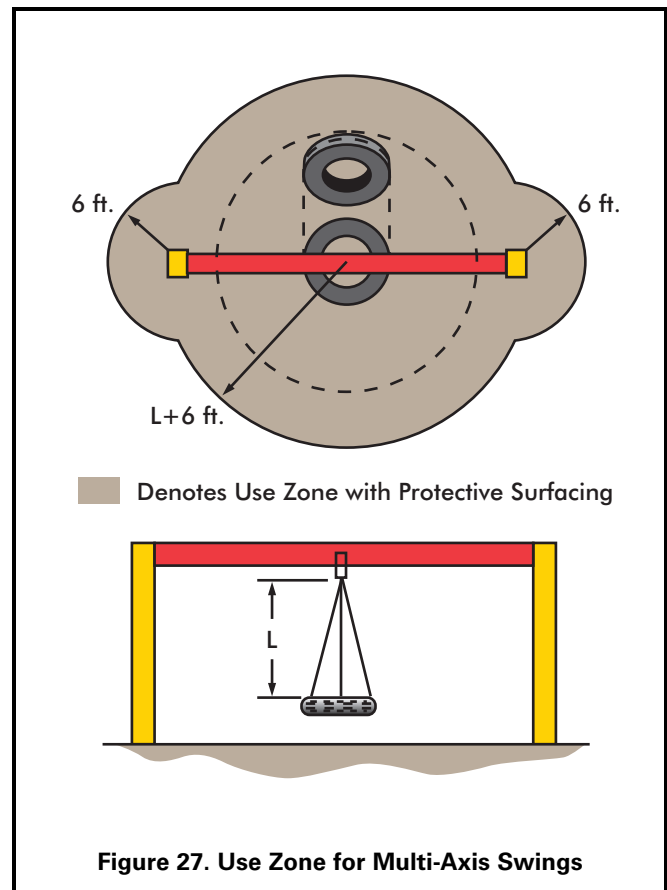
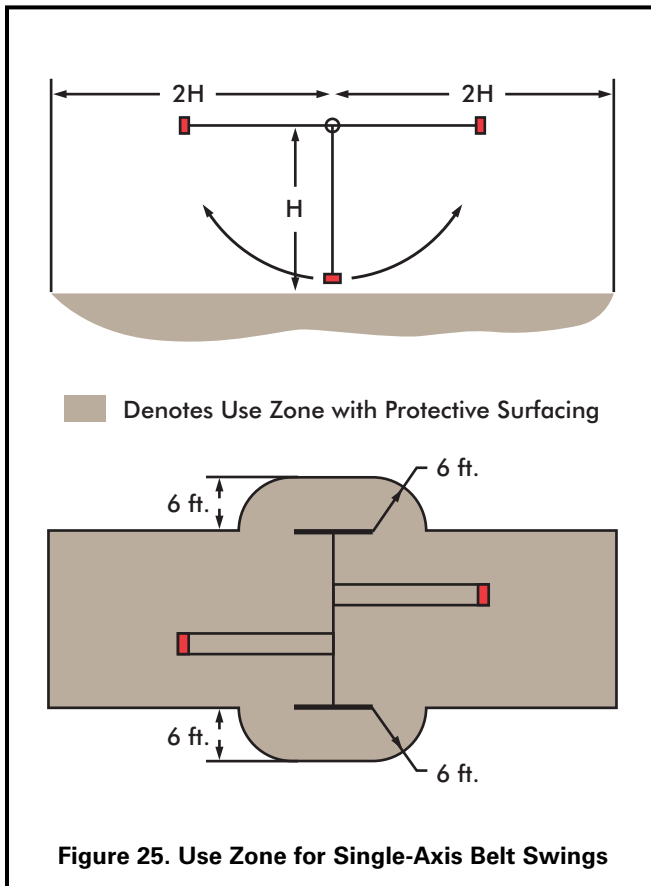
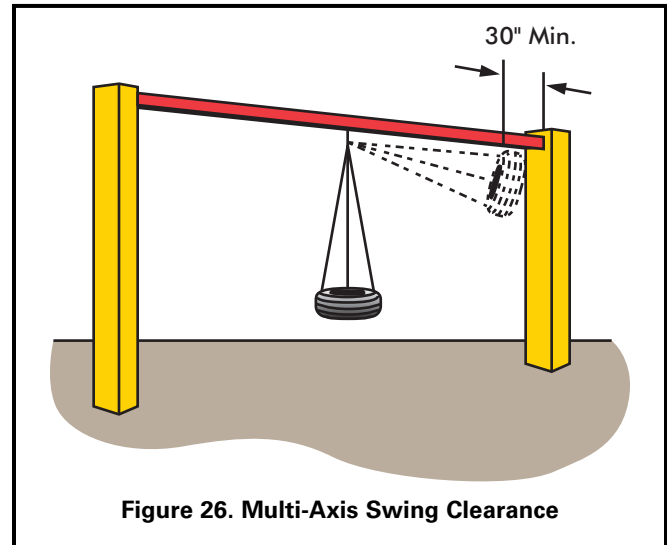

- The use zone should extend a minimum of 6 feet from the perimeter of the supporting structure. This 6-foot zone may overlap that of an adjacent swing structure or other playground equipment structure.

### 5.3.8.5 Protrusions on suspended members of swing assemblies

Protrusions on swings are extremely hazardous because of the potential for impact incidents. Nothing, including bolts or other parts, on the front, back, or underside of a swing should stick out more than 1/8 of an inch. See test procedures in Appendix B.

### 5.3.9 Fall height and use zones for composite structure

When two or more complementary play components are linked together in a composite structure (e.g., combination climber, slide, and horizontal ladder), the use zone should extend a minimum of 6 feet from the external perimeter of the structure (see Figure 28). Where slides are attached to a platform higher than 6 feet from the protective surfacing, the use zone may need to extend further in front of the slide (see §5.3.6.5).

### 5.3.10 Fall height and use zones not specified elsewhere

Most playground equipment belongs in one of the categories listed above. If it does not, the following general recommendations should be applied:

- The fall height of a piece of playground equipment is the distance between the highest designated playing surface and the protective surface beneath it.
- The use zone should extend a minimum of 6 feet in all directions from the perimeter of the equipment.
- The use zones of two stationary pieces of playground equipment that are positioned adjacent to one another may overlap if the adjacent designated play surfaces of each structure are no more than 30 inches above the protective surface and the equipment is at least 6 feet apart.
- If adjacent designated play surfaces on either structure exceed a height of 30 inches, the minimum distance between the structures should be 9 feet.
- Use zones should be free of obstacles.

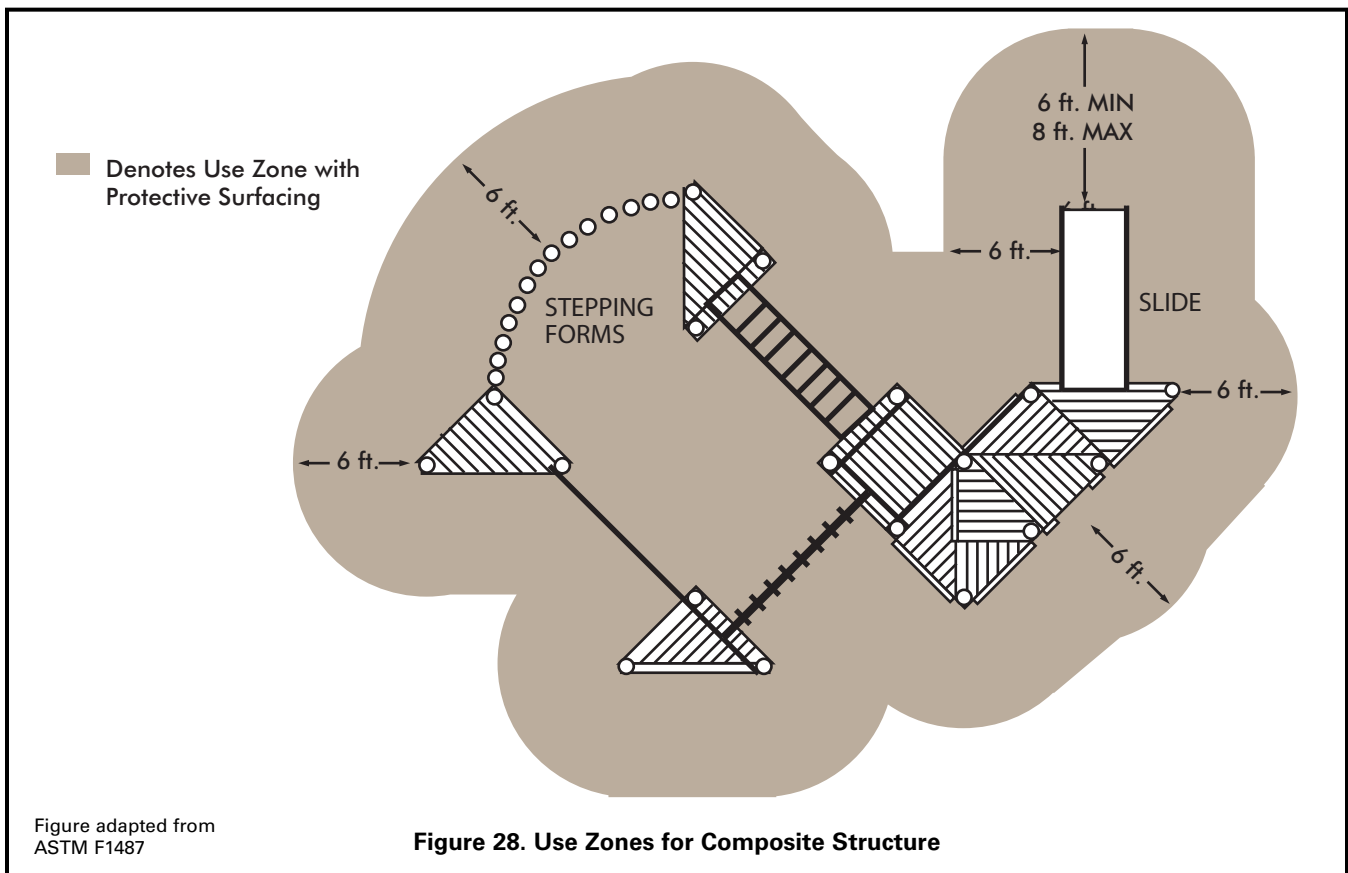

## APPENDIX A: SUGGESTED GENERAL MAINTENANCE CHECKLISTS

### Surfacing (§2.4)

- Adequate protective surfacing under and around the equipment.
  - Install/replace surfacing
- Surfacing materials have not deteriorated.
  - Replace surfacing
  - Other maintenance: \_\_\_\_\_
- Loose-fill surfacing materials have no foreign objects or debris.
  - Remove trash and debris
- Loose-fill surfacing materials are not compacted.
  - Rake and fluff surfacing
- Loose-fill surfacing materials have not been displaced under heavy use areas such as under swings or at slide exits.
  - Rake and fluff surfacing

### Drainage (§2.4)

- The entire play area has satisfactory drainage, especially in heavy use areas such as under swings and at slide exits.
  - Improve drainage
  - Other maintenance: \_\_\_\_\_

### General Hazards

- There are no sharp points, corners or edges on the equipment (§3.4).
- There are no missing or damaged protective caps or plugs (§3.4).
- There are no hazardous protrusions (§3.2 and Appendix B).
- There are no potential clothing entanglement hazards, such as open S-hooks or protruding bolts (§2.5.2, §3.2, §5.3.8.1 and Appendix B).
- There are no crush and shearing points on exposed moving parts (§3.1).
- There are no trip hazards, such as exposed footings or anchoring devices and rocks, roots, or any other obstacles in a use zone (§3.6).

### NOTES:

DATE OF INSPECTION:

### Security of Hardware (§2.5)

- There are no loose fastening devices or worn connections.
  - Replace fasteners
  - Other maintenance: \_\_\_\_\_
- Moving parts, such as swing hangers, merry-go-round bearings, and track rides, are not worn.
  - Replace part
  - Other maintenance: \_\_\_\_\_

### Durability of Equipment (§2.5)

- There are no rust, rot, cracks, or splinters on any equipment (check carefully where it comes in contact with the ground).
- There are no broken or missing components on the equipment (e.g., handrails, guardrails, protective barriers, steps, or rungs).
- There are no damaged fences, benches, or signs on the playground.
- All equipment is securely anchored.

### Leaded Paint (§2.5.4)

- Paint (especially lead paint) is not peeling, cracking, chipping, or chalking.
- There are no areas of visible leaded paint chips or accumulation of lead dust.
  - Mitigate lead paint hazards

### General Upkeep of Playgrounds (§4)

- There are no user modifications to the equipment, such as strings and ropes tied to equipment, swings looped over top rails, etc.
  - Remove string or rope
  - Correct other modification
- The entire playground is free from debris or litter such as tree branches, soda cans, bottles, glass, etc.
  - Clean playground
- There are no missing trash receptacles.
  - Replace trash receptacle
- Trash receptacles are not full.
  - Empty trash

INSPECTION BY:

## **Routine Inspection and Maintenance Issues**

- Broken equipment such as loose bolts, missing end caps, cracks, etc.
- Broken glass & other trash
- Cracks in plastics
- Loose anchoring
- Hazardous or dangerous debris
- Insect damage
- Problems with surfacing
- Displaced loose-fill surfacing (see Section 4.3)
- Holes, flakes, and/or buckling of unitary surfacing
- User modifications (such as ropes tied to parts or equipment rearranged)
- Vandalism
- Worn, loose, damaged, or missing parts
- Wood splitting
- Rusted or corroded metals
- Rot

# APPENDIX B: PLAYGROUND TESTING

## B.1 Templates, Gauges, and Testing Tools

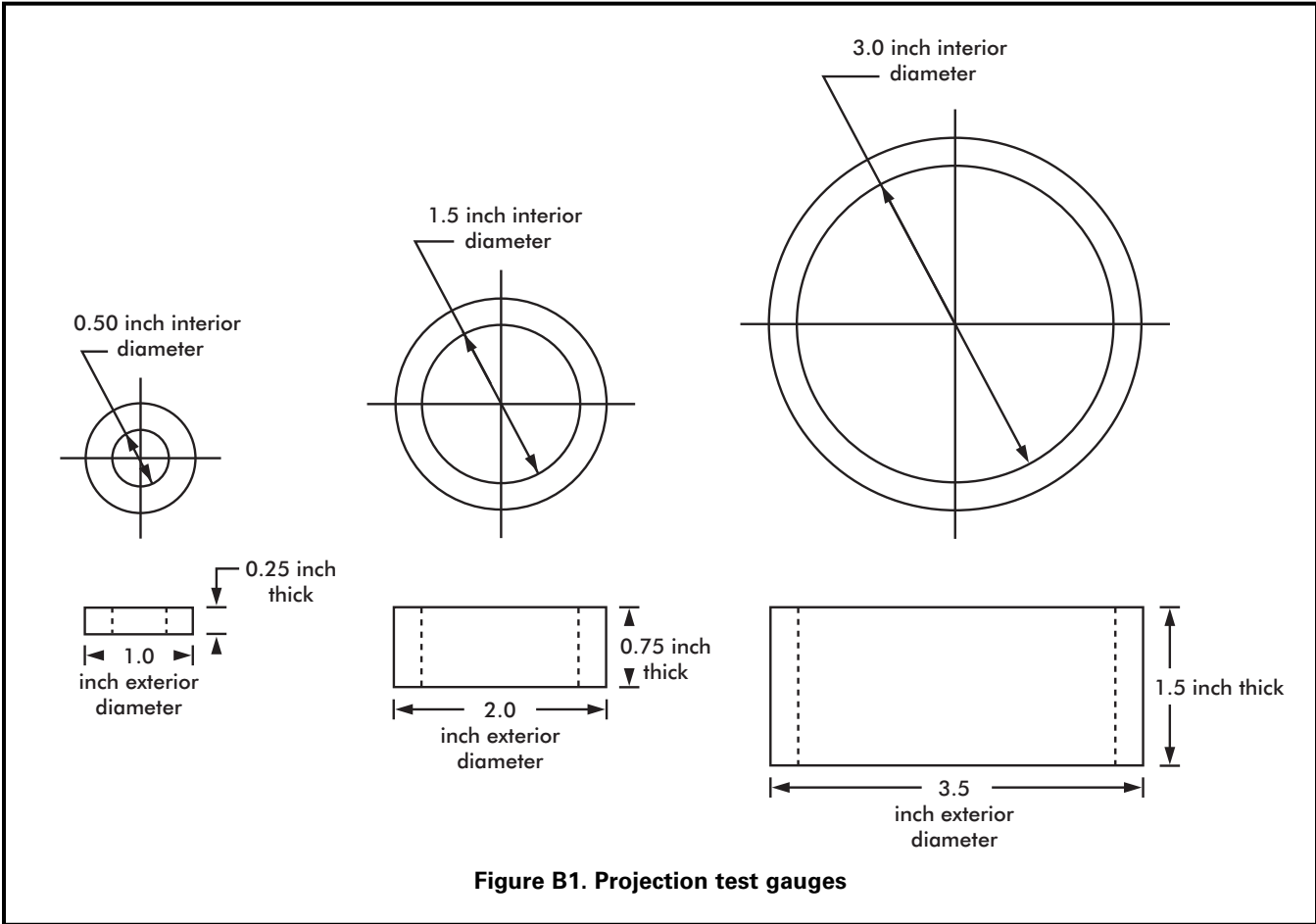

Figure B1. Projection test gauges

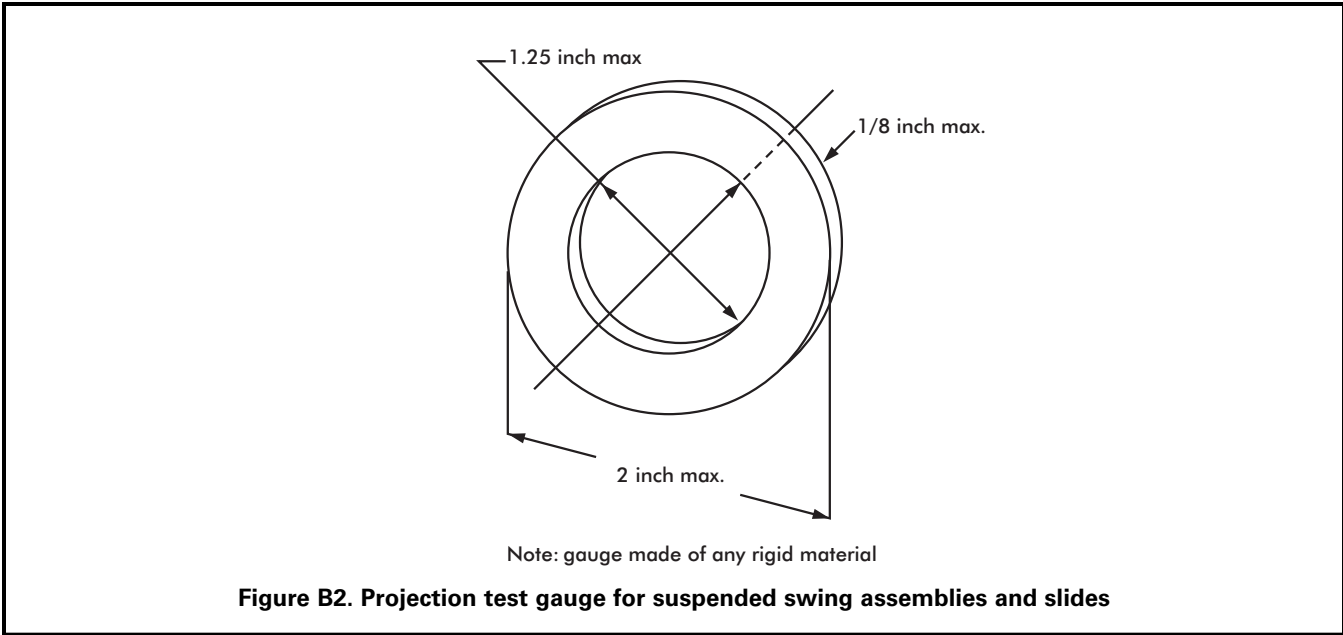
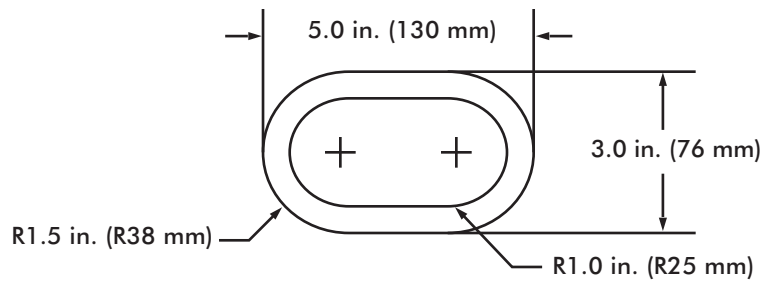
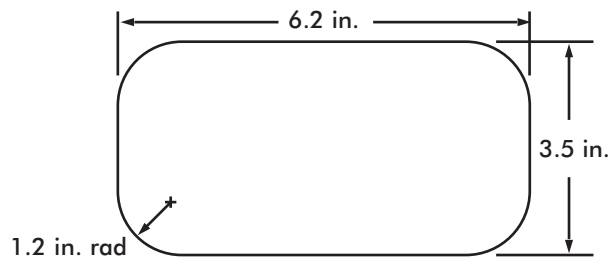

Figure B2. Projection test gauge for suspended swing assemblies and slides

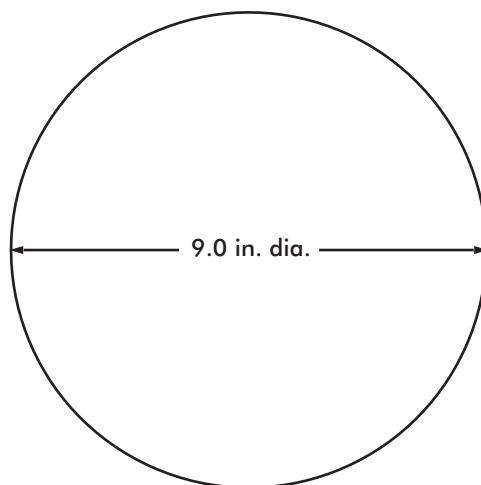



**Figure B3. Toddler small torso template**



**Figure B4. Preschool- and school-age small torso template**



**Figure B5. Large head template**

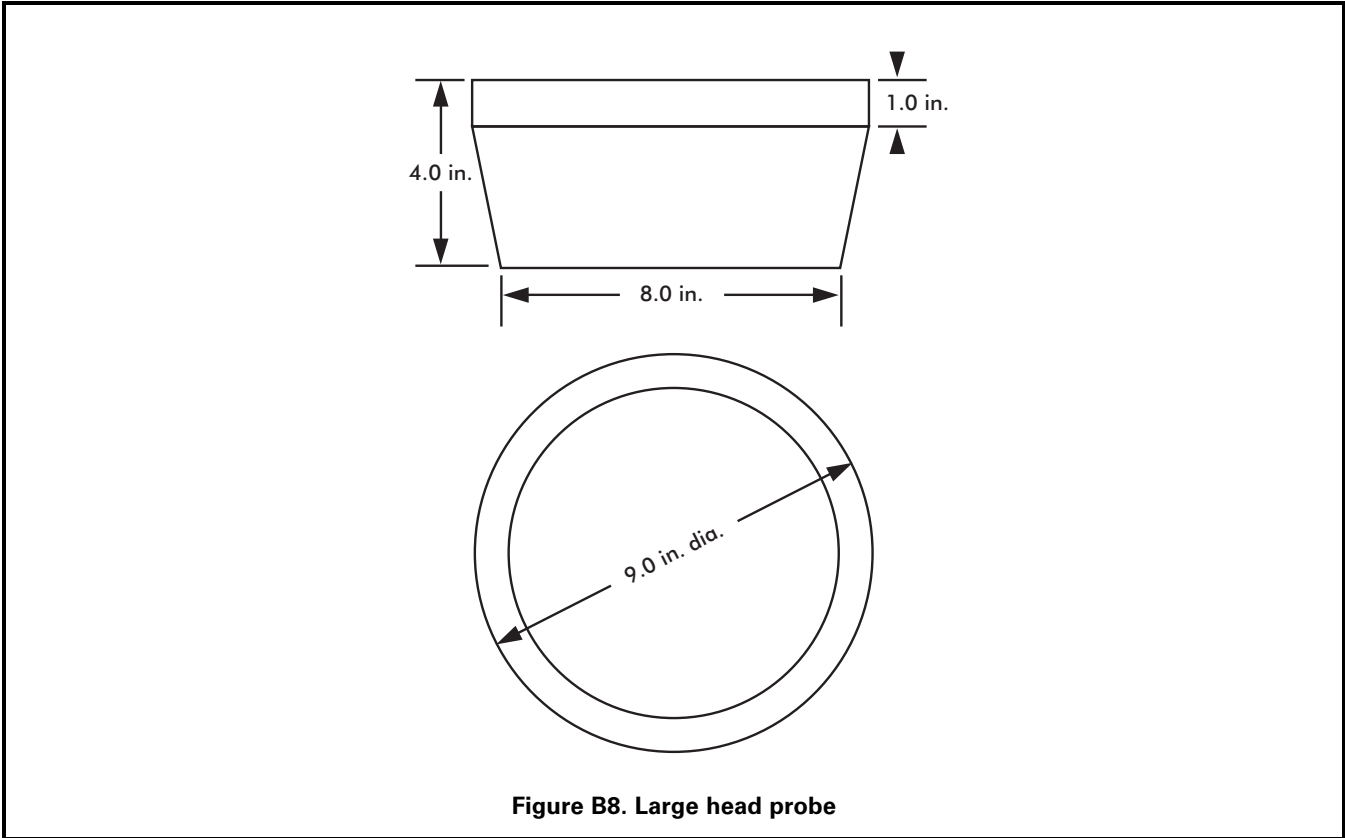
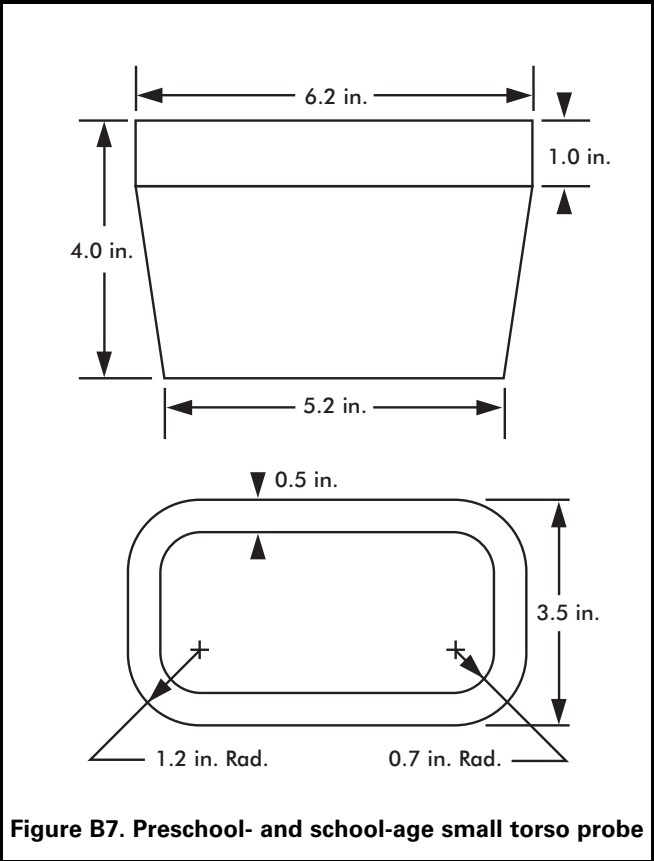
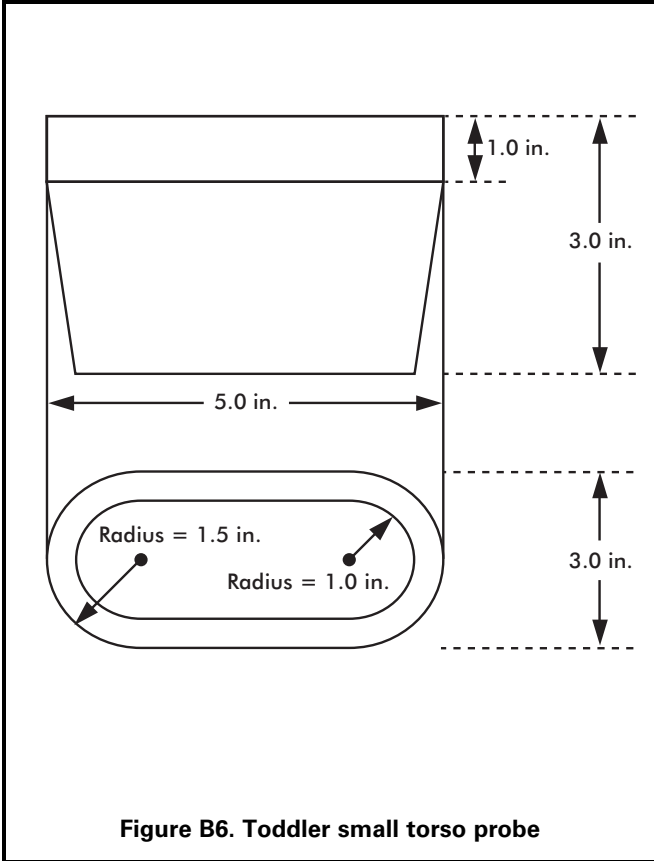

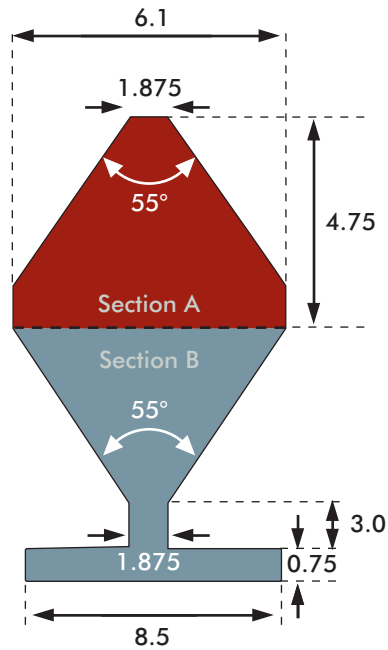

Figure B9. Preschool/School-age partially bound probe (dimensions in inches, template is 0.75 inches thick)

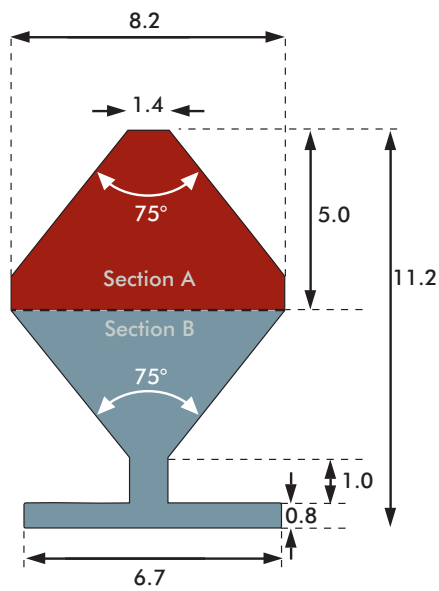

Figure B10. Toddler partially bound probe (dimensions in inches, template is 0.60 inches thick)

## APPENDIX B: PLAYGROUND TESTING

### B.2 Test Methods

#### B.2.1 Determining whether a projection is a protrusion

##### B.2.1.1 Test procedure

Step 1: Successively place each projection test gauge (see Figure B1) over any projection

Step 2: Visually determine if the projection penetrates through the hole and beyond the face of the gauge (see Figure B11 below).

**Pass:** A projection that does not extend beyond the face of the gauge passes.

**Fail:** A projection that extends beyond the face of any one of the gauges is considered a hazardous protrusion and should be eliminated.

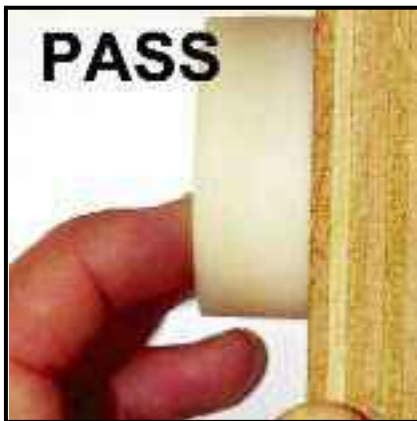

**Figure B11. Determining whether a projection is a protrusion**

#### B.2.2 Projections on suspended members of swing assemblies

Given the potential for impact incidents, projections on swings can be extremely hazardous. A special test gauge (see Figure B2) and procedure are recommended. When tested, no bolts or components in the potential impact region on suspended members should extend through the hole beyond the face of the gauge.

##### B.2.2.1 Test procedure

Step 1: Hold the gauge (Figure B2) vertically with the axis through the hole parallel to the swing's path of travel.

Step 2: Place the gauge over any projections that are exposed during the swing's path of travel.

Step 3: Visually determine if the projection penetrates through the hole and beyond the face of the gauge.

**Pass:** A projection that does not extend beyond the face of the gauge passes.

**Fail:** A projection that extends beyond the face of the gauge is considered a hazardous protrusion and should be eliminated.

#### B.2.3 Projections on slides

To minimize the likelihood of clothing entanglement on slides, projections that (1) fit within any one of the three gauges shown in Figure B1 and (2) have a major axis that projects away from the slide bed should not have projections greater than 1/8 inch perpendicular to the plane of the surrounding surface (Figure B12).

##### B.2.3.1 Test procedure

Step 1: Identify all projections within the shaded area shown in Figure B13.

Step 2: Determine which, if any, fit inside the projection test gauges (Figure B1).

Step 3: Place the swing and slide projection gauge (Figure B2) next to the projection to check the height of the projection.

Step 4: Visually determine if the projection extends beyond the face of the slide projection gauge.

**Pass:** A projection that does not extend beyond the face of the gauge passes.

**Fail:** A projection that extends beyond the face of the gauge is considered a hazardous protrusion and should be eliminated.

*NOTE: This test procedure is not applicable to the underside of a slide chute. For a slide chute with a circular cross section, the portion of the underside not subject to this projection recommendation is shown in Figure 18. The general recommendations for projections in §B.2.1 are applicable to the underside of the slide.*

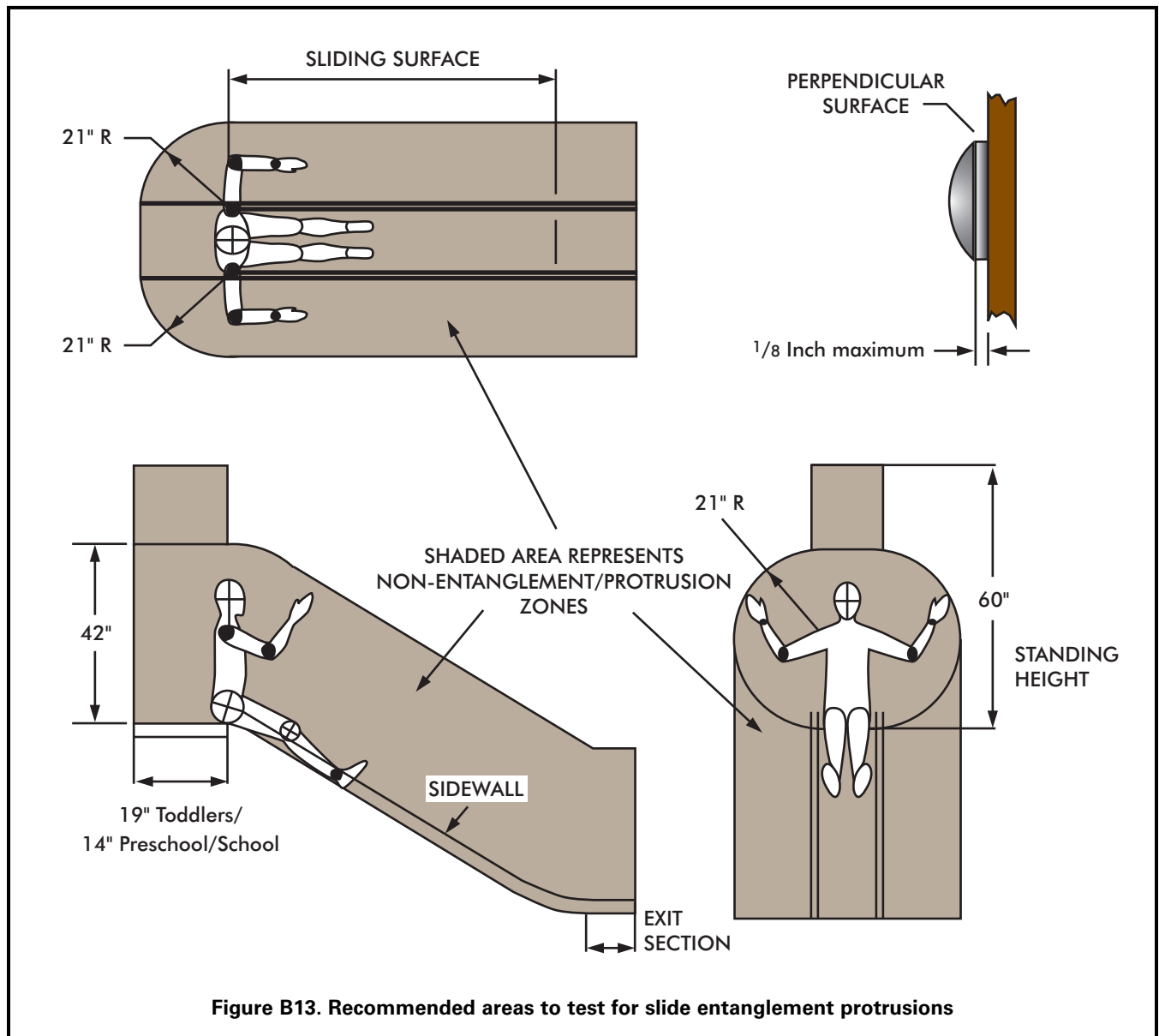
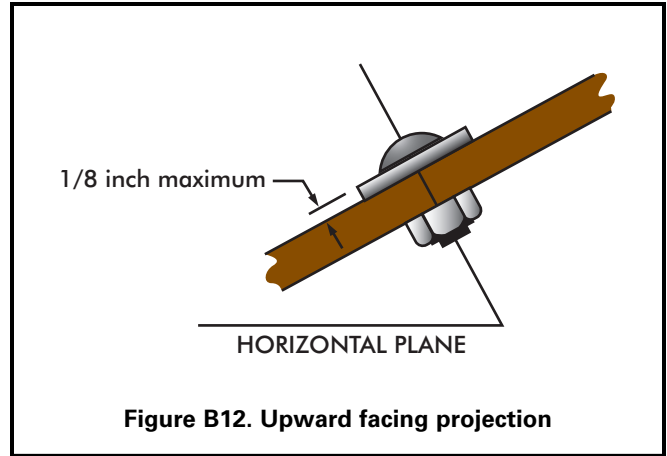

## B.2.4 Entrapment

### B.2.4.1 General

Any completely-bounded opening (Figure B14) that is not bounded by the ground may be a potential head entrapment hazard. Even those openings which are low enough to permit a child's feet to touch the ground present a risk of strangulation to an entrapped child, because younger children may not have the necessary intellectual ability and motor skills to withdraw their heads, especially if scared or panicked. An opening may present an entrapment hazard if the distance between any interior opposing surfaces is greater than 3.5 inches and less than 9 inches. If one dimension of an opening is within this potentially hazardous range, all dimensions of the opening should be considered together to fully evaluate the possibility of entrapment. The most appropriate method to determine whether an opening is hazardous is to test it using the following fixtures, methods, and performance criteria.

These recommendations apply to all playground equipment, i.e., toddler, preschool-age, and school-age children. Fixed equipment as well as moving equipment (in its stationary position) should be tested for entrapment hazards. There are two special cases for which separate procedures are given: (1) completely-bounded openings where depth of penetration is a critical issue (see Figure B15) and (2) openings formed by flexible climbing components.

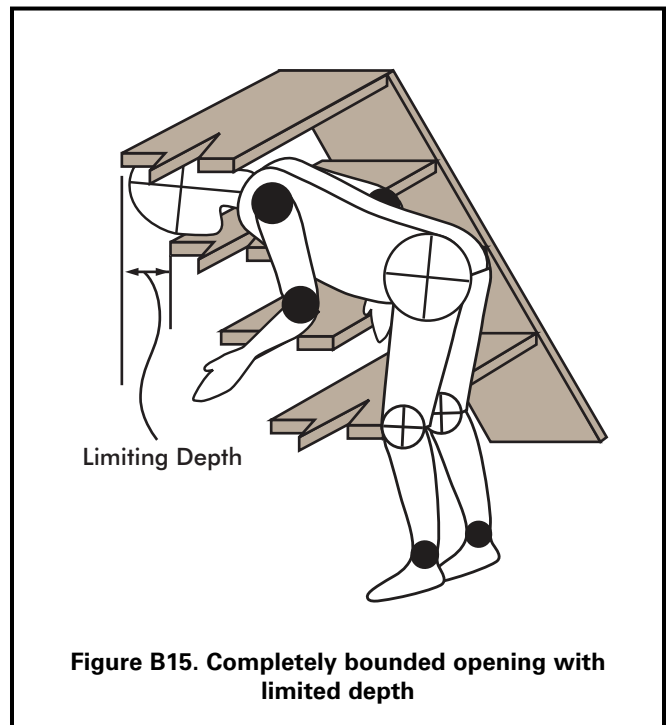
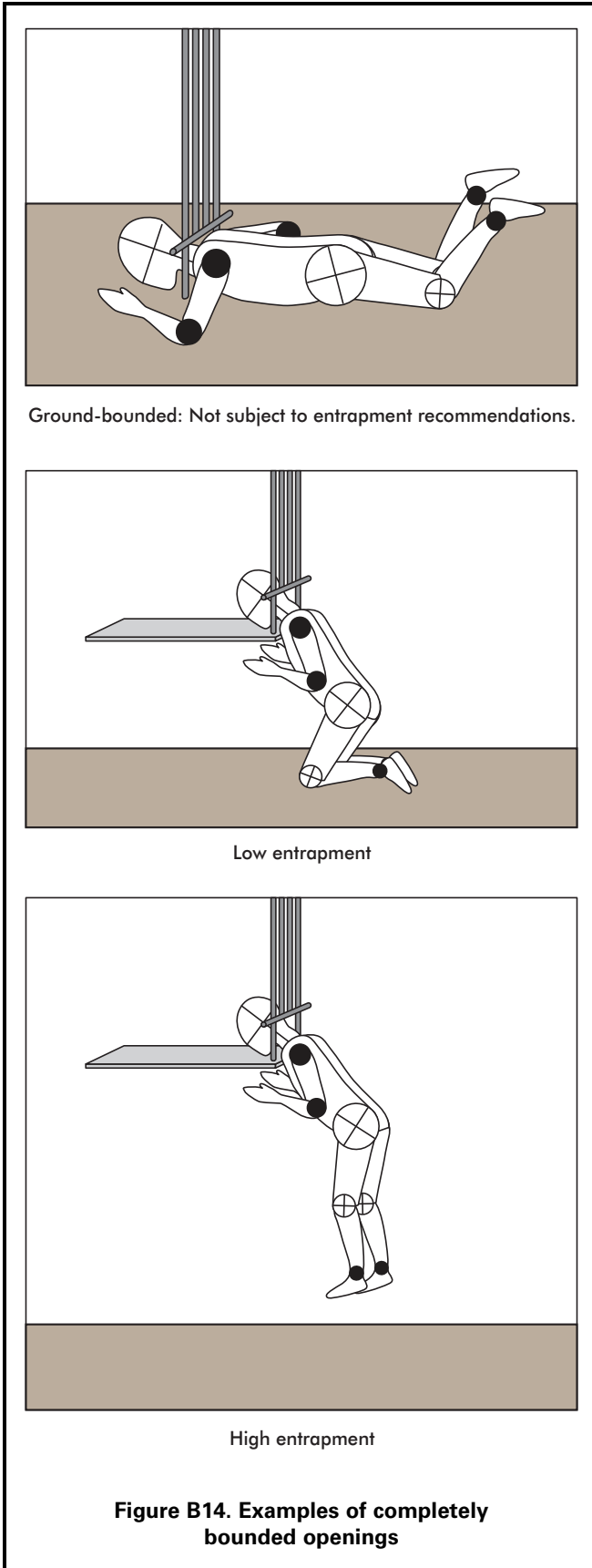

### B.2.5 Test fixtures

Two templates are required to determine if completely bounded openings in rigid structures present an entrapment hazard. These templates can easily be fabricated from cardboard, plywood, or sheet metal.

#### B.2.5.1 Small torso template

The dimensions (see Figure B3 and Figure B4) of this template are based on the size of the torso of the smallest user at risk (5th percentile 6-month-old child for Figure B3 and 2-year-old child for Figure B4). If an opening is too small to admit the template, it is also too small to permit feet first entry by a child. Because children’s heads are larger than their torsos, an opening that does not admit the small torso template will also prevent head first entry into an opening by a child.

#### B.2.5.2 Large head template

The dimensions (see Figure B5) of this template are based on the largest dimension on the head of the largest child at risk (95th percentile 5-year-old child). If an opening is large enough to permit free passage of the template, it is large enough to permit free passage of the head of the largest child at risk in any orientation. Openings large enough to permit free passage of the large head template will not entrap the chest of the largest child at risk.

#### B.2.5.3 Completely bounded openings with unlimited depth

##### B.2.5.3.1 Test procedure

- Step 1: Select the appropriate small torso template based on the intended users of the playground (Figure B3 for toddler playgrounds, Figure B4 for preschool- and school-age playgrounds).
- Step 2: Identify all completely bounded openings.
- Step 3: Attempt to place the small torso template in the opening with the plane of the template parallel to the plane of the opening. While keeping it parallel to the plane of the opening, the template should be rotated to its most adverse orientation (i.e., major axis of template oriented parallel to the major axis of the opening.)

- Step 4: Determine if the small torso template can freely pass through the opening.

No: **Pass.** Stop

Yes: Continue



- Step 5: Place the large head template in the opening, again with the plane of the template parallel to the plane of the opening, and try to insert it through the opening.

**Pass:** The large head template can be freely inserted through the opening

**Fail:** The opening admits the small torso template but does not admit the large head template.



### B.2.5.4 Completely bounded openings with limited depth of penetration

The configuration of some openings may be such that the depth of penetration is a critical issue for determining the entrapment potential. For example, consider a vertical wall or some other barrier behind a step ladder. The entrapment potential depends not only on the dimensions of the opening between adjacent steps but also on the horizontal space between the lower boundary of the opening and the barrier. A child may enter the opening between adjacent steps feet first and may proceed to pass through the space between the rear of the lower step and the barrier and become entrapped when the child's head is unable to pass through either of these two openings. In effect, there are openings in two different planes, and each has the potential for head entrapment and should be tested.

Figure B16 illustrates these two planes for a step ladder as well as for a generic opening. Plane A is the plane of the completely bounded opening in question, and Plane B is the plane of the opening encompassing the horizontal space between the lower boundary of the opening in Plane A and the barrier that should also be tested for entrapment hazards.

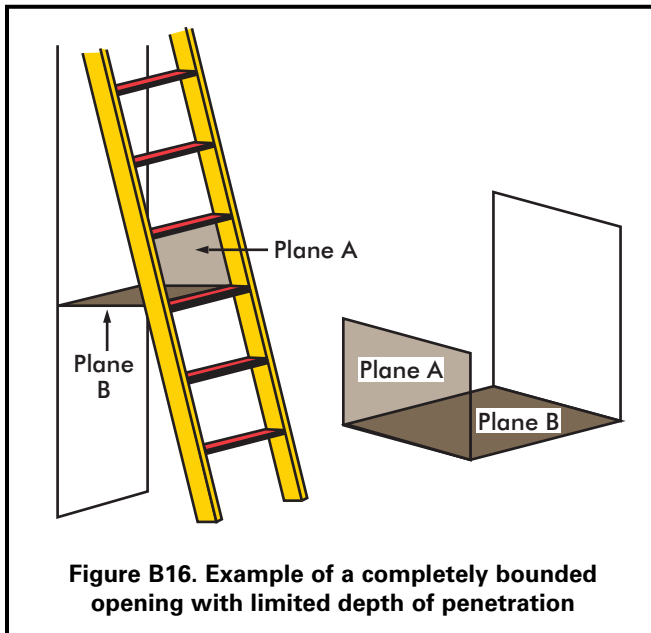

#### B.2.5.4.1 Test procedure

Step 1: Select the appropriate small torso template based on the intended users of the playground (Figure B3 for toddler playgrounds, Figure B4 for preschool-age and school-age playgrounds).

Step 2: Identify all completely bounded openings with limited depth of penetration.

Step 3: Place the small torso template in the opening in Plane A with its plane parallel to Plane A; rotate the template to its most adverse orientation with respect to the opening while keeping it parallel to Plane A.

Step 4: Determine if the opening in Plane A admits the small torso template in any orientation when rotated about its own axis.

**No: Pass.** The opening is small enough to prevent either head first or feet first entry by the smallest user at risk and is not an entrapment hazard.

**Yes:** Continue.

Step 5: Place the small torso template in the opening in Plane B with its plane parallel to Plane B; rotate the template to its most adverse orientation with respect to the opening while keeping it parallel to Plane B.

Step 6: Determine if the opening in Plane B admits the small torso template.

**No: Pass.** The depth of penetration into the opening in Plane A is insufficient to result in entrapment of the smallest user at risk.

**Yes:** Continue.

Step 7: Place the large head template (Figure B5) in the opening in Plane A with its plane parallel to Plane A. Determine if the opening in Plane A admits the large head template.

**No: Fail.** A child, whose torso can enter the opening in Plane A as well as the opening in Plane B, may become entrapped by the head in the opening in Plane A.

**Yes:** Continue.

Step 8: With the plane of the large head template parallel to the opening in Plane B, determine if the opening in Plane B admits the large head template.

**No: Fail.** The largest user at risk cannot exit the opening in Plane B.

**Yes: Pass.** The openings in Plane A and Plane B do not pose an entrapment risk.



### B.2.5.5 Flexible openings

Climbing components such as flexible nets are also a special case for the entrapment tests because the size and shape of openings on this equipment can be altered when force is applied, either intentionally or simply when a child climbs on or falls through the openings. Children are then potentially at risk of entrapment in these distorted openings.

The procedure for determining conformance to the entrapment recommendations for flexible openings requires two three-dimensional test probes which are illustrated in Figure B6, Figure B7, and Figure B8 are applied to an opening in a flexible component with a force of up to 50 pounds.

#### B.2.5.5.1 Test procedure

- Step 1: Select the appropriate small torso template based on the intended users of the playground (Figure B3 for toddler playgrounds, Figure B4 for preschool-age and school-age playgrounds).
- Step 2: Identify all completely bounded openings with flexible sides.
- Step 3: Place the small torso probes (Figures B6 and B7) in the opening, tapered end first, with the plane of its base parallel to the plane of the opening.
- Step 4: Rotate the probe to its most adverse orientation (major axis of probe parallel to major axis of opening) while keeping the base parallel to the plane of the opening.
- Step 5: Determine if the probe can be pushed or pulled completely through the opening by a force no greater than 30 pounds on toddler playgrounds or 50 pounds on preschool-age and school-age playgrounds.

No: Pass. Stop

Yes: Continue.



Step 6: Place the large head probe (Figure B8) in the opening with the plane of its base parallel to the plane of the opening.

Step 7: Determine if the large head probe can be pushed or pulled completely through the opening by a force no greater than 30 pounds on toddler playgrounds or 50 pounds on preschool-age and school-age playgrounds.

Yes: Pass. Stop.

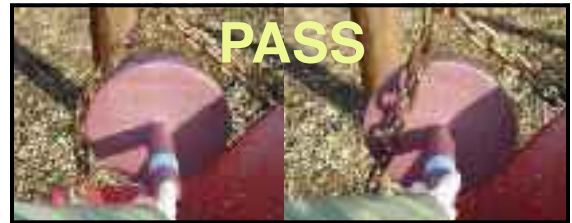

No: Fail.



### B.2.5.6 Partially bound openings

A partially bound opening is any opening which has at least one side or portion open, such as a U- or V-shaped opening. These openings can still pose an entrapment hazard by allowing the neck to enter but not allowing the head to slip out. A partially bound opening can be any part of the playground equipment where a child could get his or her neck caught, so it includes not only two- or three-sided openings, but also areas of large openings (large enough for the head template to enter) that have the characteristics that can entrap a child's neck. Several examples outlines of this situation are shown in the figures below. Openings that have an outline similar to these figures are often found when two parts of a playground meet, for example, the top of a slide and the side of a guardrail.

Identifying partially bound openings varies depending on the age range of the playground. Openings that should be tested include any opening where:

For toddlers:

- The perimeter of the opening is not closed
- The lowest leg of the opening is tilted upward (i.e. above horizontal) or 45 degrees below horizontal.

For preschool- and school-age:

- The perimeter of the opening is not closed
- The lowest leg of the opening is tilted upward (i.e. above horizontal)



**Examples of partially bound openings. Note, these examples are intended to illustrate the principle of partially bound openings and may or may not require testing.**

**B.2.5.6.1 Test procedure**

Step 1: Select the appropriate Partially Bound Template based on the intended users of the playground (Figure B10 for toddler playgrounds, Figure B9 for preschool and school-age playground).

Step 2: Identify partially bound openings.

Step 3: Align the template so that the face of the template is parallel to the plane of the opening and the narrow tip of the A section is pointing toward the opening.

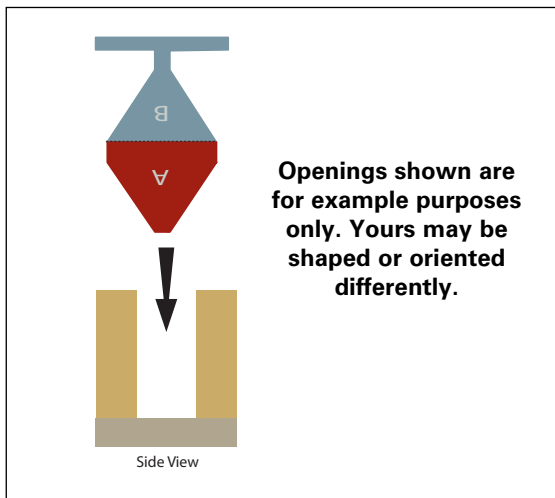

Step 4: Insert the A portion of the template into the opening following the centerline of the opening.

Step 5: Once inserted as far as possible, determine if there is simultaneous contact between the sides of the opening and both of the top corners at the narrow tip of section A.

**Yes:** Pass. Stop

**No:** continue

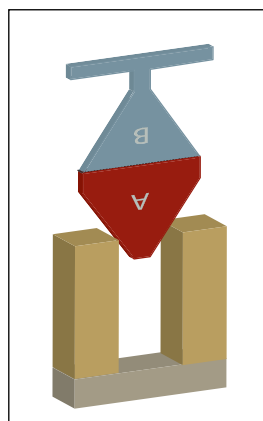
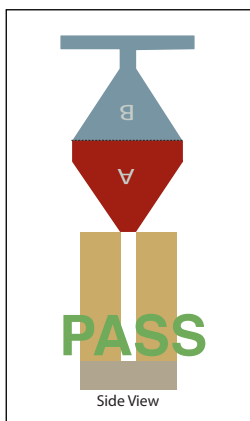

Step 6: While still inserted as far as possible, determine if there is simultaneous contact between both of the angled sides of section A and the sides of the opening.

**Yes:** Note the points on the sides of opening where contact was made and continue

**No:** Pass. The narrow tip should be resting on the lower boundary of the opening with no contact with the sides of the opening. Stop

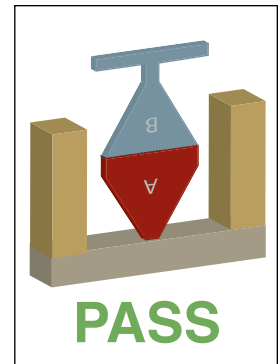
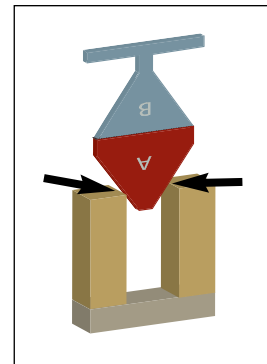

Step 7: Remove the template and turn the template so that the face of the template is perpendicular to the opening.

Step 8: Following the plane of the opening, insert the B portion of the template into the opening so that the narrow part of the B portion is between the sides of the opening.

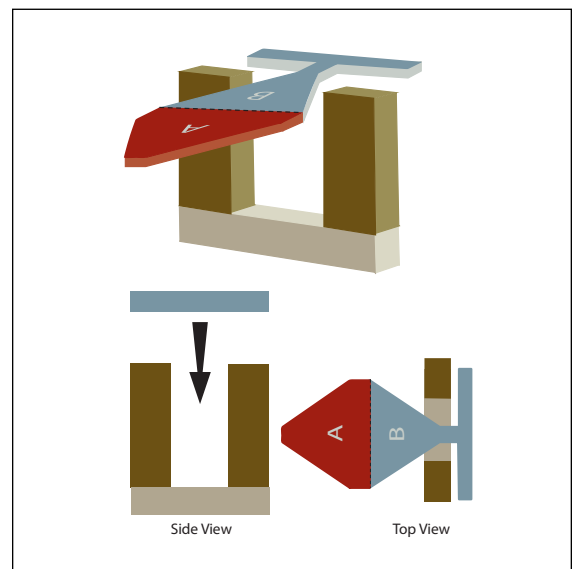

Step 9: Once inserted as far as possible, determine if the B portion is completely past the points where contact was made on the sides of the opening with the A portion.

No: Pass. Stop

Yes: Toddlers:  
Fail. Stop  
Preschool and  
School-age:  
Continue

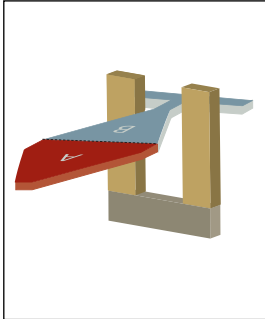

Step 11: Determine if the Large Head Template passes freely through the larger opening.

Yes: Pass

No: Fail

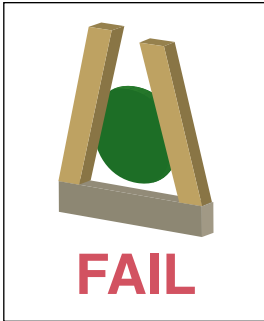

Step 10: Determine if the B portion can reach a point where the opening increases in size.

No: Fail. Stop

Yes: continue

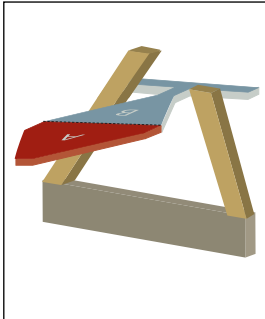
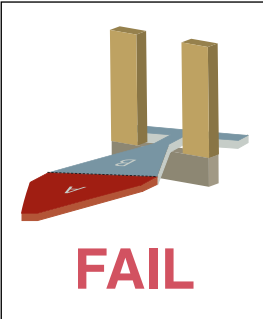

**U.S. CONSUMER PRODUCT  
SAFETY COMMISSION**

**4330 EAST WEST HIGHWAY  
BETHESDA, MD 20814**

**OFFICIAL BUSINESS  
PENALTY FOR PRIVATE USE, \$300**

**AN EQUAL OPPORTUNITY EMPLOYER**