

KIDS WHO CARE

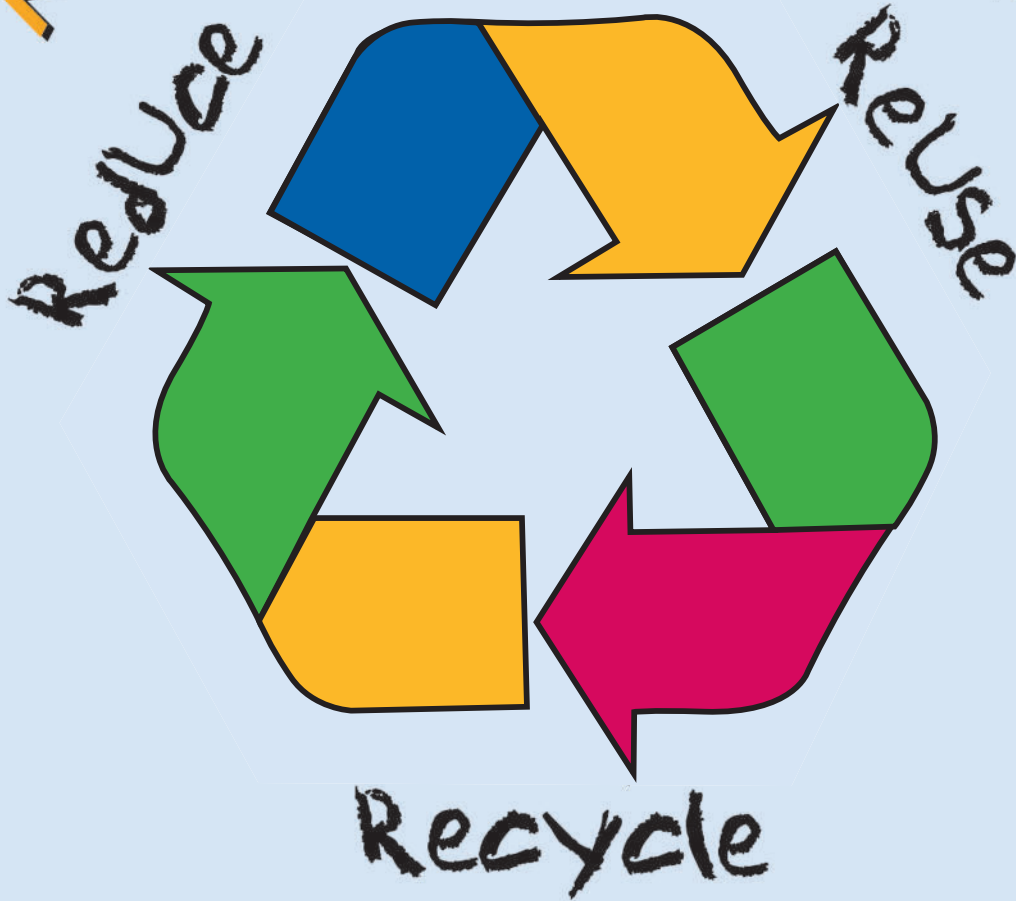

**RECYCLE RIGHT!
RECYCLE SMART!**

This workbook is owned by:

"A Kid Who Cares"



City of Phoenix

PUBLIC WORKS DEPARTMENT
SOLID WASTE EDUCATION
www.phoenix.gov/GARBAGE
602-262-7231

WHAT IS GARBAGE?

Circle which one you have thrown away.

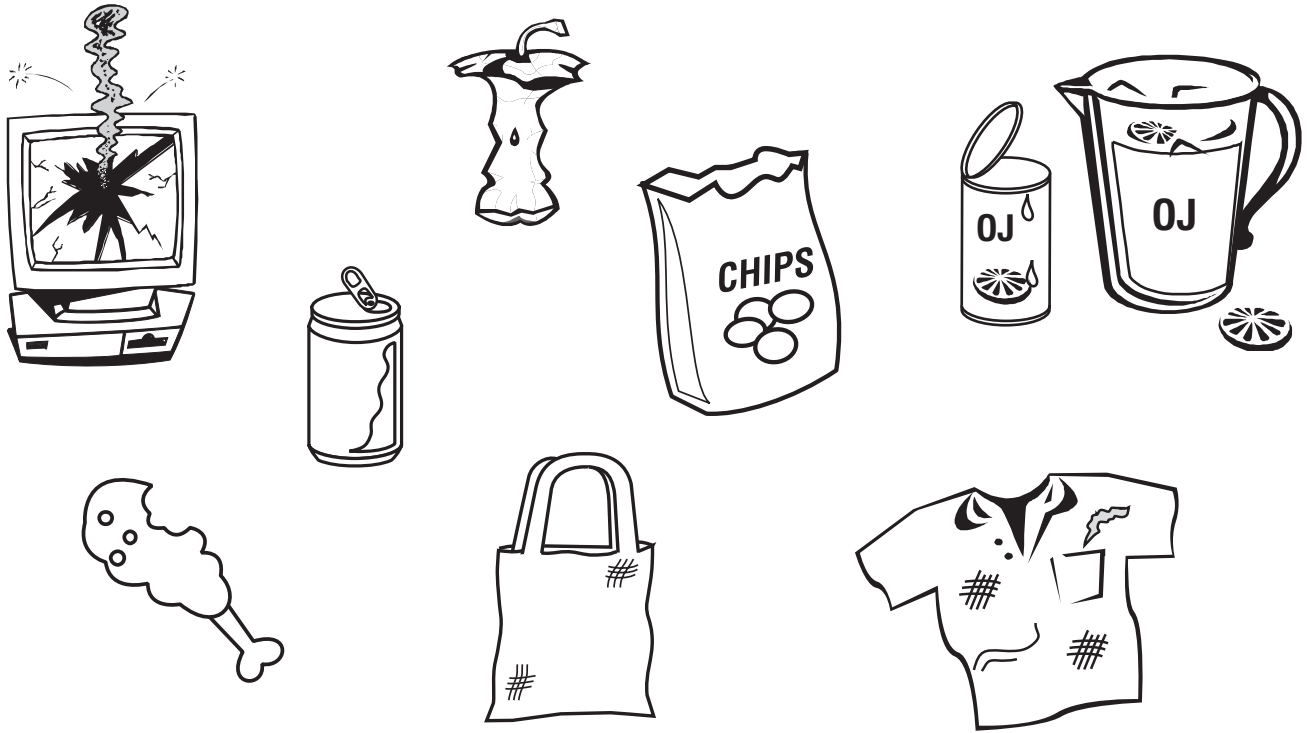

WHAT IS A LANDFILL?

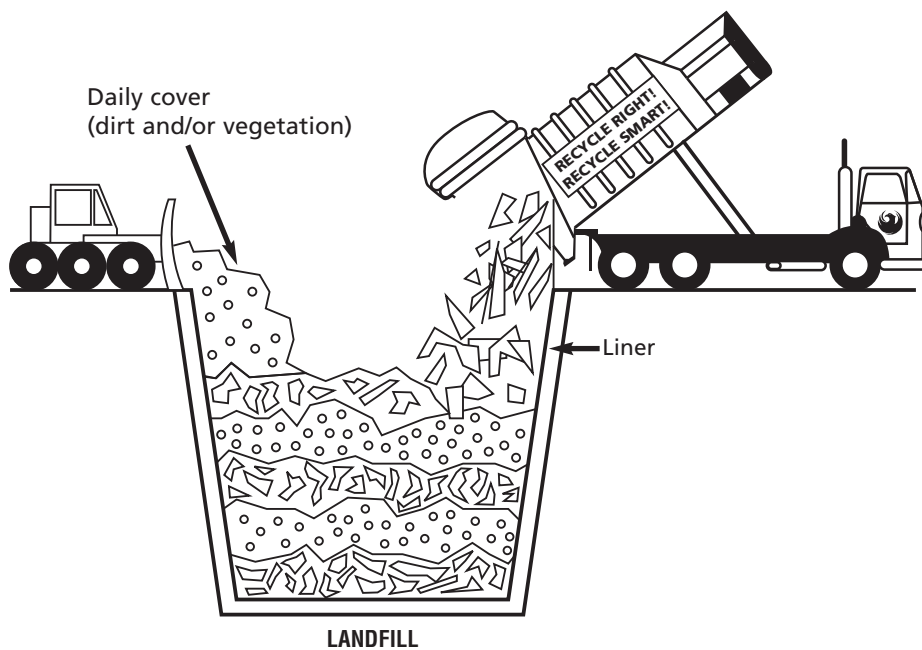

REDUCE REDUCE REDUCE REDUCE



5 examples of reducing your garbage

Reduce garbage by buying in bulk.
One can of frozen orange juice instead
of gallon plastic containers.

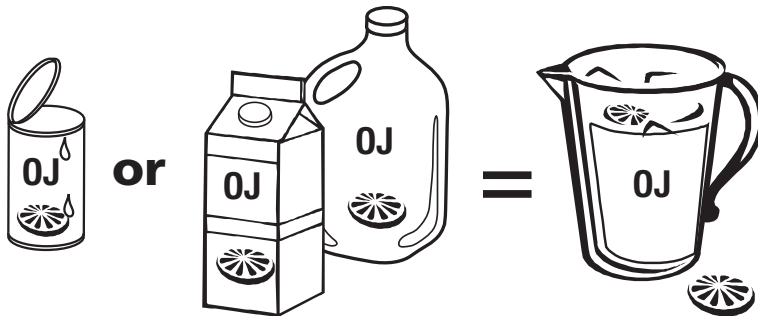

Reduce garbage by using cloth
bags over and over instead of
many plastic bags.

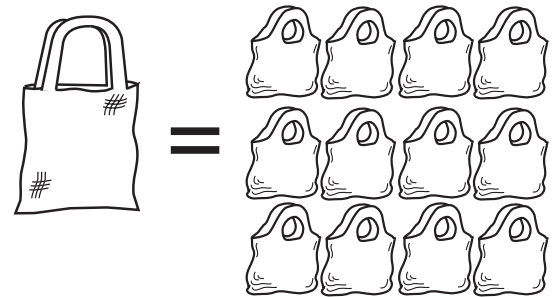

Reduce garbage by buying
a lunchbox. One lunchbox
is equal to many paper
lunch sacks.

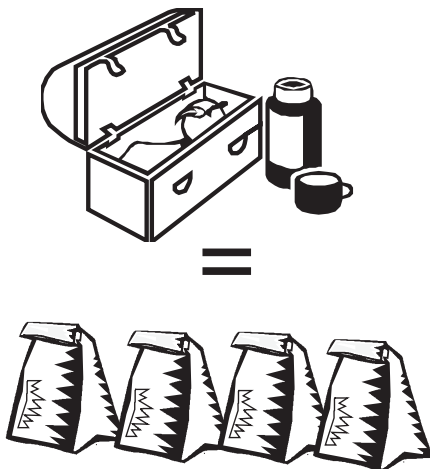

Reduce paper cards and envelopes by sending
greeting cards on E-mail.

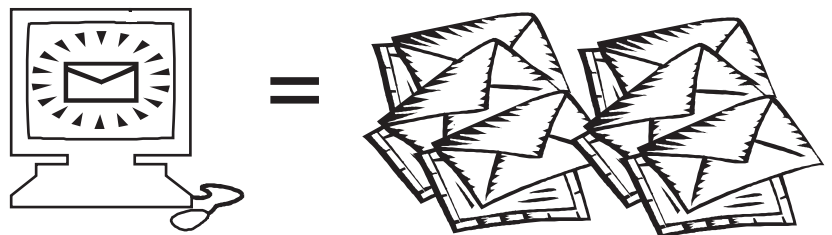

Reduce paper cereal carton boxes by buying in
bulk plastic cereal bags.

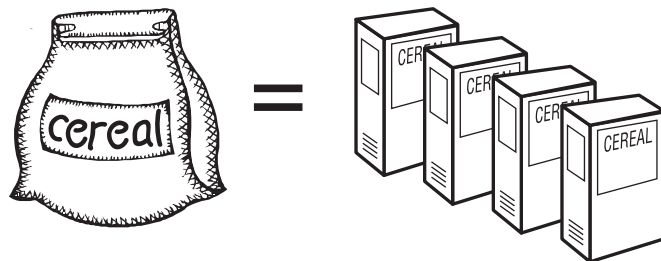

 Cut here for bookmark

1 2 3 4 5 6



Recycling RULES!

visit: www.phoenix.gov/GARBAGE



REUSE ➡ REUSE ➡ REUSE



What is reuse?

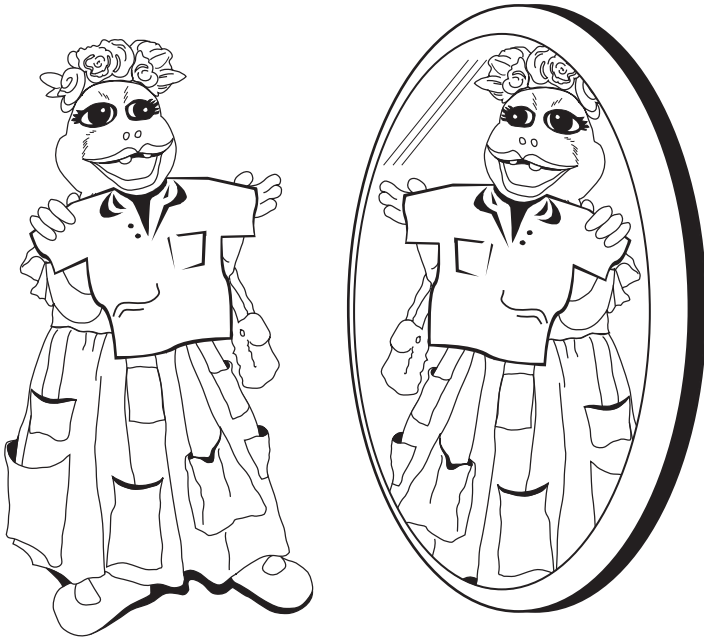

Reuse by donating an old shirt or sofa.

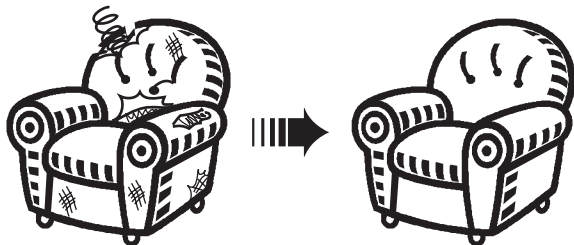

or

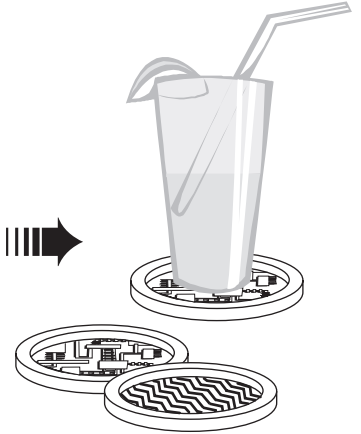

Reuse toys by giving to other kids.



Reuse garbage by using a plastic bottle for a bird feeder.

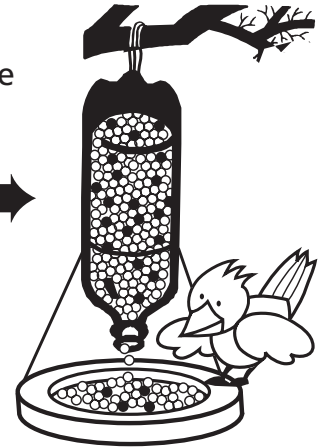

REUSEASAURUS

Born: America Recycles Day, November 15
Age: A lady doesn't answer that question
Family: Recyclesaurus (Cousin from another era)
Birthplace: Somewhere in the United States of America
Education: Dino U
Profession: Reuser, Inventor, Repairer
Hobbies: Yard sale shopping, Consignment stores, History books
Favorite TV show: Junkyard Wars
Thing I dislike most: Littering

KIDS WHO CARE
 602-262-7251

RECYCLESASAURUS

Born: Earth Day (April 22)
Birth Place: Phoenix Landfill
Height: Still Growing
Weight: Still Growing
Hobby: Paleontology
Favorite Activity: Recycling

resaurus@phoenix.gov





RECYCLE

Buy Recycle...
Close the Loop



What is recycling?



Aluminum Can

OLD



NEW

Milk cartons into toilet tissue

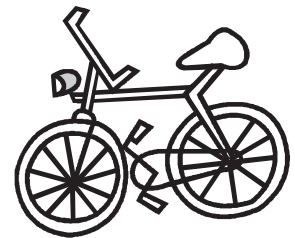
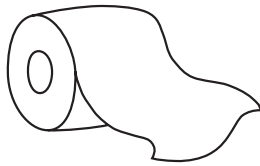

"Tin" Can

Bicycle

Sand



Glass Bottles

Worn out money

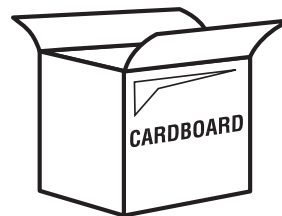

Blue Jeans

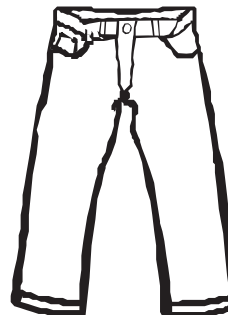

Soda Bottle



Shoe laces



WHAT IS GARBAGE?

WHERE DOES IT GO?

REDUCE

Draw an arrow (like this) to throw out the right way

REUSE

RECYCLE



GARBAGE

PHOENIX RECYCLES LIST FOR CITY OF PHOENIX

Recycle these items only!



Plastics

Check bottom of containers for code symbols **1** or **2**. These include 2-liter soda bottles, detergent bottles, milk jugs, and shampoo bottles

- **NO PLASTIC BAGS**, pool chemical containers, dinnerware or frozen dinner trays



Foam

Food containers such as meat trays, cups, egg cartons or packing materials with the code symbol **6**

- **No "peanut" packing material**



Glass

Food and beverage containers only [labels OK]

- **No light bulbs, glassware, ceramics, mirrors or window glass**



Paper

Such as computer, construction and writing paper, file folders, grocery bags

- **No facial or toilet tissue, paper towels, napkins, diapers, pet food bags, or thermal fax paper**



Junk mail

- **No self-sealing envelopes**



Magazines/Telephone Books

Catalogs and staples OK

- **No paperback or hardbound books**



Newspapers

Include all inserts

- **Remove plastic bags**



Cardboard/chipboard

Packing, facial tissue boxes, dry food boxes such as cereal, cake mix and cracker containers [remove liners], shoe and gift boxes, towel and tissue rolls

- **No bar soap or detergent boxes, OR 6- AND 12-PACK BEER AND SODA CARRIERS, or frozen food boxes**



Milk cartons

Includes juice and creamer cartons and juice boxes [remove caps and straws]



Aluminum

Beverage cans, frozen dinner trays, pie plates, foil, food containers

- **Do not crush**



Metal

Such as food cans [labels OK], metal lids, small metal appliances, hub caps, scrap metal, **EMPTY** aerosol cans, screen doors [remove rubber lining], lawn chairs [remove webbing], wire clothes hangers

- **All material must be clean, dry & empty**
- **No grass, yard or food waste**
- **Do not bag, box or tie**
- **Buy recycled and recyclable!**



For more information, call
602-262-7251

EMAIL: pwwork@phoenix.gov

WEB SITE: www.phoenix.gov/GARBAGE

TTY: **602-253-8796**



City of Phoenix

PUBLIC WORKS DEPARTMENT

101 South Central Avenue
Phoenix, Arizona 85004

DO'S AND DON'TS

RECYCLE RIGHT! RECYCLE SMART!



Recycle Right!



- Check for these symbols on plastic bottles, lids are okay.
- Discard all liners from cereal, cake and cookie boxes in the garbage.
- Break down large cardboard boxes.
- Don't crush soda or soup cans.
- Remove metal lids from glass jars.
- Recycle all small metal appliances like irons, skillets and VCR's. No TV's
- Make sure all recyclables are clean, dry and empty.

Reuse Right!

- Plastic bags: Reuse plastic bags at the grocery store or to "Bag and Tie" your garbage and grass. Some dry cleaners and grocery stores accept bags for recycling. Please do not put them in your blue recycling barrel.
- Glass dishware: Donate or resell old glasses, plates and cups.
- Toys, shoes, and clothing: If you have outgrown these items, give them away to someone who does not have them.
- Books: Donate old books to a library, senior center or charity organization.
- Paint or Batteries: Take household hazardous waste like paint or batteries to a monthly Battery, Oil, Paint and Antifreeze (BOPA) collection site. Call 602-262-7251 or visit www.phoenix.gov/GARBAGE for more information.

Reduce Right!

- Buy in bulk
- Buy in concentrate form.
- Use cloth bags and not plastic bags

Bag and Tie Right!

- Throw away 6/12 pack soda boxes (paper is treated and is not easily recycled)
- Dispose of potato chip bags and candy bar wrappers
- Toss bar soap and dry detergent boxes in the garbage (treated paper)
- Dump frozen food boxes for ice cream and dinners in the garbage.
- Throw out broken glass mirrors, windows, light bulbs and television tubes.
- Make sure to bag and tie all of these items before placing them in your green/black garbage barrel.

Call:
602-262-7251

E-mail:
resaurus@phoenix.gov

